



VoIP Loudspeaker Amplifier Operations Guide (PoE)

Part #010861

CyberData Corporation
2555 Garden Road
Monterey, CA 93940
(831) 373-2601

VoIP Loudspeaker Amplifier Operations Guide 930106F
Part # 010861

COPYRIGHT NOTICE:

© 2009, CyberData Corporation, ALL RIGHTS RESERVED.

This manual and related materials are the copyrighted property of CyberData Corporation. No part of this manual or related materials may be reproduced or transmitted, in any form or by any means (except for internal use by licensed customers), without prior express written permission of CyberData Corporation. This manual, and the products, software, firmware, and/or hardware described in this manual are the property of CyberData Corporation, provided under the terms of an agreement between CyberData Corporation and recipient of this manual, and their use is subject to that agreement and its terms.

DISCLAIMER: Except as expressly and specifically stated in a written agreement executed by CyberData Corporation, CyberData Corporation makes no representation or warranty, express or implied, including any warranty or merchantability or fitness for any purpose, with respect to this manual or the products, software, firmware, and/or hardware described herein, and CyberData Corporation assumes no liability for damages or claims resulting from any use of this manual or such products, software, firmware, and/or hardware. CyberData Corporation reserves the right to make changes, without notice, to this manual and to any such product, software, firmware, and/or hardware.

OPEN SOURCE STATEMENT: Certain software components included in CyberData products are subject to the GNU General Public License (GPL) and Lesser GNU General Public License (LGPL) "open source" or "free software" licenses. Some of this Open Source Software may be owned by third parties. Open Source Software is not subject to the terms and conditions of the CyberData COPYRIGHT NOTICE or software licenses. Your right to copy, modify, and distribute any Open Source Software is determined by the terms of the GPL, LGPL, or third party, according to who licenses that software.

Software or firmware developed by CyberData that is unrelated to Open Source Software is copyrighted by CyberData, subject to the terms of CyberData licenses, and may not be copied, modified, reverse-engineered, or otherwise altered without explicit written permission from CyberData Corporation.

TRADEMARK NOTICE: CyberData Corporation and the CyberData Corporation logos are trademarks of CyberData Corporation. Other product names, trademarks, and service marks may be the trademarks or registered trademarks of their respective owners.





Phone: (831) 373-2601
Technical Support Ext. 333
support@cyberdata.net
Fax: (831) 373-4193
Company and product information at www.cyberdata.net

Revision History



Revision	Date Released	Description of Changes
A	11/06/2006	This is the first release of this manual.
B	01/16/2007	Adds Section 2.4, "Set up the MGROUPS" .
C	4/13/2007	Changes the Authenticate ID and password character limit from 30 to 25 in Table 2-11 .
D	7/20/2007	Adds Figure 2-16, "MGROUPS Setup" . Adds more information about MGROUPS in Section 2.4, "Set up the MGROUPS" . Adds information about the Outbound Proxy in Table 2-11 .
E	3/19/2008	Adds information about the Line Out Output in Section 2.2.3.1, "Using the Line Out Output" . Adds the following safety information to Table 2-5 : "Prior to installation, consult local building/electrical code requirements."
F	3/9/2009	Adds the following text to Section 2.2.3.3, "Cabling/Wiring" : "For maximum output, use two 8-Ohm speakers that are wired in parallel with the shortest possible cable length (total combined length should not exceed more than 25 feet)."

Important Safety Instructions

1. Read these instructions.
2. Keep these instructions.
3. Heed all warnings.
4. Follow all instructions.
5. Do not use this apparatus near water.
6. Clean only with dry cloth.
7. Do not block any ventilation openings. Install in accordance with the manufacturer's instructions.
8. Do not install near any heat sources such as radiators, heat registers, stoves, or other apparatus (including amplifiers) that produce heat.
9. Do not defeat the safety purpose of the polarized or grounding-type plug. A polarized plug has two blades with one wider than the other. A grounding type plug has two blades and a third grounding prong. The wide blade or the third prong are provided for your safety. If the provided plug does not fit into your outlet, consult an electrician for replacement of the obsolete outlet.
10. Protect the power cord from being walked on or pinched particularly at plugs, convenience receptacles, and the point where they exit from the apparatus.
11. Only use attachments/accessories specified by the manufacturer.
12. Refer all servicing to qualified service personnel. Servicing is required when the apparatus has been damaged in any way, such as power-supply cord or plug is damaged, liquid has been spilled or objects have fallen into the apparatus, the apparatus has been exposed to rain or moisture, does not operate normally, or has been dropped.
13. Prior to installation, consult local building and electrical code requirements.
14. **WARNING: The Loudspeaker Amplifier enclosure is not rated for any AC voltages!**

 <p>GENERAL ALERT</p>	<p>Warning <i>Electrical Hazard:</i> This product should be installed by a licensed electrician according to all local electrical and building codes.</p>
 <p>GENERAL ALERT</p>	<p>Warning <i>Electrical Hazard:</i> To prevent injury, this apparatus must be securely attached to the floor/wall in accordance with the installation instructions.</p>

Pictorial Alert Icons

	<p>General Alert</p> <p><i>This pictorial alert indicates a potentially hazardous situation. This alert will be followed by a hazard level heading and more specific information about the hazard.</i></p>
	<p>Ground</p> <p><i>This pictorial alert indicates the Earth grounding connection point.</i></p>

Hazard Levels

Danger: Indicates an imminently hazardous situation which, if not avoided, will result in death or serious injury. This is limited to the most extreme situations.

Warning: Indicates a potentially hazardous situation which, if not avoided, could result in death or serious injury.

Caution: Indicates a potentially hazardous situation which, if not avoided, could result in minor or moderate injury. It may also alert users against unsafe practices.

Notice: Indicates a statement of company policy (that is, a safety policy or protection of property).

The safety guidelines for the equipment in this manual do not purport to address all the safety issues of the equipment. It is the responsibility of the user to establish appropriate safety, ergonomic, and health practices and determine the applicability of regulatory limitations prior to use. Potential safety hazards are identified in this manual through the use of words *Danger*, *Warning*, and *Caution*, the specific hazard type, and pictorial alert icons.

Contents

Chapter 1 Product Overview	1
1.1 Typical System Installation	1
1.2 Product Features	2
1.3 Supported Protocols	3
1.4 Supported SIP Servers	3
1.5 Product Specifications	3
Chapter 2 Installing the VoIP Loudspeaker Amplifier	5
2.1 Parts List	5
2.2 Loudspeaker Amplifier Setup	6
2.2.1 Loudspeaker Amplifier Components	6
2.2.2 Loudspeaker Amplifier Jumpers	7
2.2.3 Connect the Loudspeaker Amplifier	8
2.2.4 Confirm Operation	11
2.2.5 Confirm the IP Address, Test the Audio, and Check the Volume	12
2.2.6 Adjust the Volume	13
2.3 Configure the Loudspeaker Amplifier Parameters	14
2.3.1 Log in to the Configuration Home Page	14
2.3.2 Configure the Network Parameters	17
2.3.3 Set up the Loudspeaker Amplifier	19
2.3.4 Configure the SIP Parameters	20
2.4 Set up the MGROUPS	23
2.5 Upgrade the Firmware and Reboot the Loudspeaker Amplifier	25
2.5.1 Reboot the Loudspeaker Amplifier	27
2.6 Restore the Factory Default Settings	29
Appendix A Mounting the Enclosure	31
A.0 Mount the Enclosure	31
Appendix B Setting up a TFTP Server	33
B.0 Set up a TFTP Server	33
B.0.1 In a LINUX Environment	33
B.0.2 In a Windows Environment	33
Appendix C Troubleshooting/Technical Support	35
C.1 Frequently Asked Questions (FAQ)	35
C.2 Documentation	35
C.3 Contact Information	35
C.4 Warranty	36
Index	37

1 Product Overview

The Voice-over-IP (VoIP) Loudspeaker Amplifier (PoE) uses a single cable to connect to existing LANs to broadcast digital audio over your public address system. The small footprint and low height makes this an ideal loudspeaker amplifier to discreetly mount almost anywhere.

1.1 Typical System Installation

Figure 1-1 illustrates how the VoIP Loudspeaker Amplifier (PoE) is normally installed as part of a public address system.

Figure 1-1. Public Address System—SIP

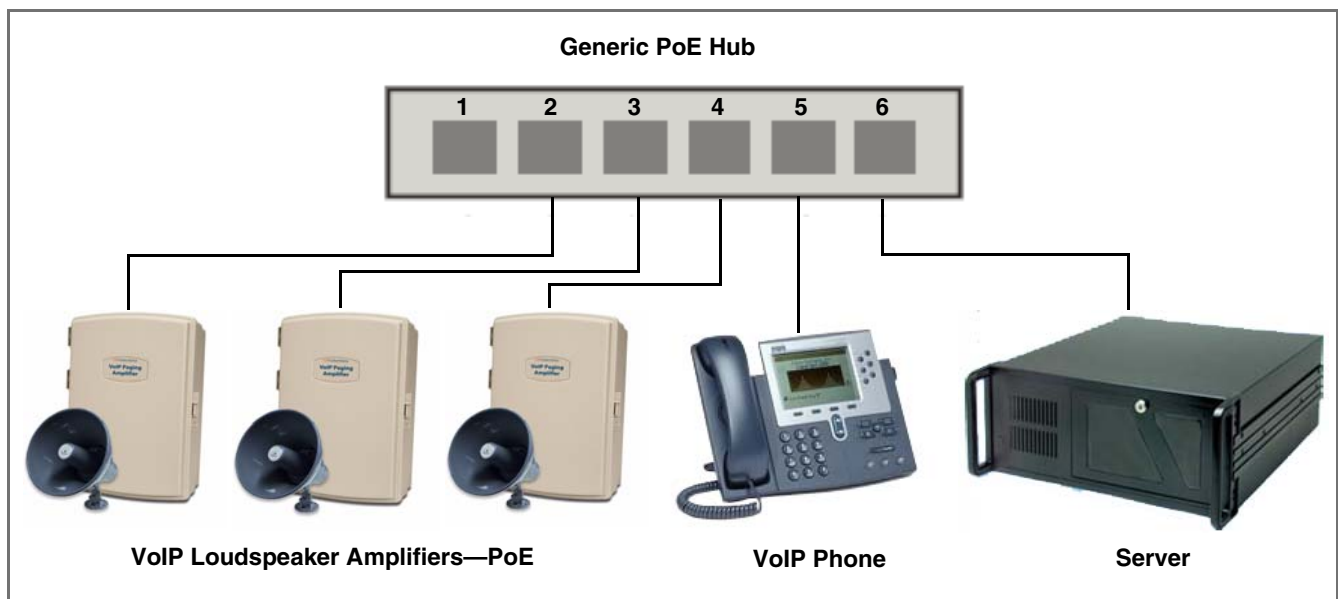
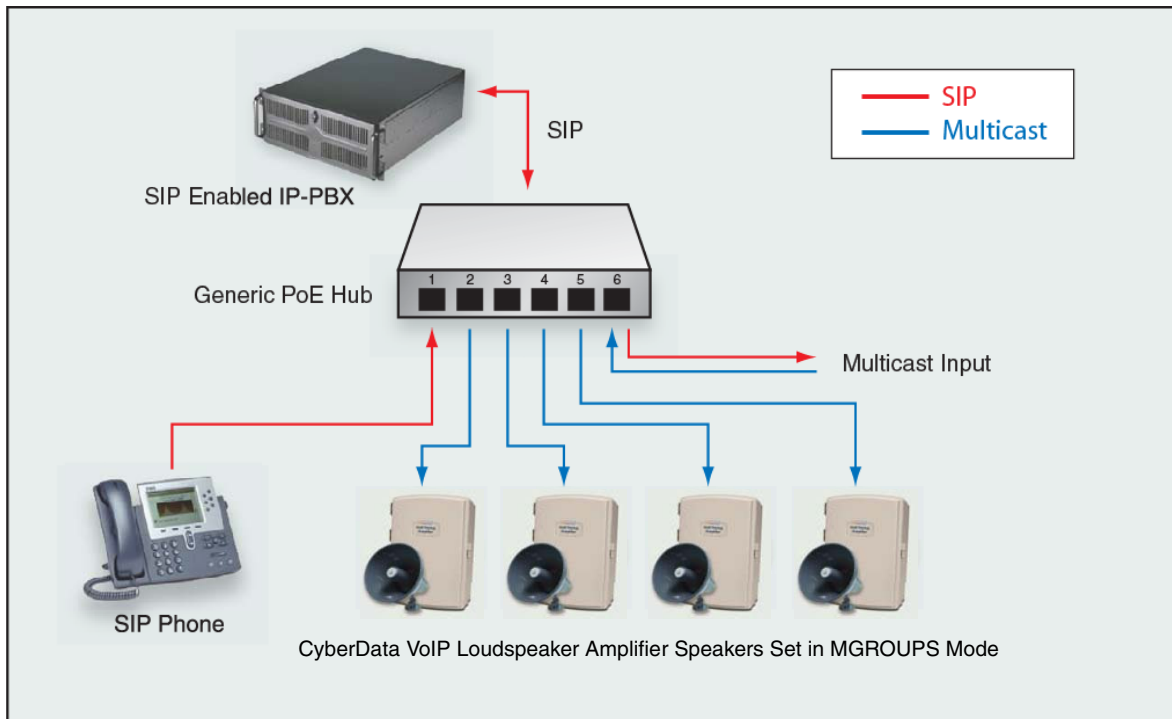
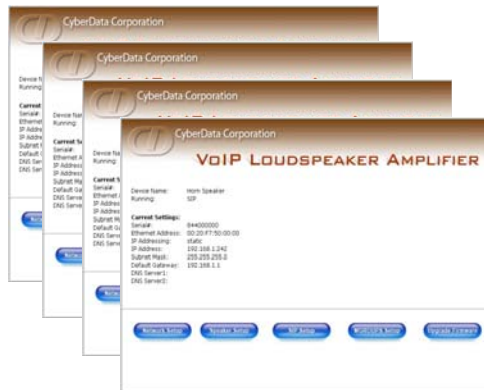

Figure 1-2. Public Address System—Multicast



1.2 Product Features



- Multicast support
- SIP (RFC 3261) compatible
- Dual-Speed 10/100 Mbps
- Web-based configuration
- Web-based firmware upgradeable
- High-efficiency speaker driver
- PoE (Power-over-Ethernet)
- 8W output under PoE
- 16W max. output (Non-PoE)
- Supports 8 ohm horn speakers
- Moisture-proof NEMA enclosure

1.3 Supported Protocols

The IP Speaker supports:

- SIP
- Multicast
- HTTP Web-based configuration
Provides an intuitive user interface for easy system configuration and verification of loudspeaker amplifier operations.
- DHCP Client
Dynamically assigns IP addresses in addition to the option to use static addressing.
- TFTP Client
Facilitates Web-based firmware upgrades of the latest loudspeaker amplifier capabilities.
- RTP
- RTP/AVP - Audio Video Profile
- Audio Encodings
PCMU (G.711 mu-law)
PCMA (G.711 A-law)
Packet Time 20 ms

1.4 Supported SIP Servers

The following link contains information on how to configure the loudspeaker amplifier for the supported SIP servers:

<http://www.cyberdata.net/support/voip/index.html>

1.5 Product Specifications



Category	Specification
Sensitivity	96dB/1W/1M S.P. Level
Output	8 W PoE/16 W with internal power supply
Port Baud Rate	10/100 Mbps
Power Requirement	802.3af compliant
Protocol	SIP RFC 3261
Part Number	010861
Dimensions	14" x 10" x 4"
Weight	4.4 lbs.

2 Installing the VoIP Loudspeaker Amplifier

2.1 Parts List

Table 2-1 illustrates the parts for each loudspeaker amplifier and includes a kit for mounting.

Table 2-1. Parts List

Quantity	Part Name	Illustration
1	Loudspeaker Amplifier Assembly	
1	Installation Quick Reference Guide	
1	Loudspeaker Amplifier Mounting Accessory Kit (part #070057A) which includes: 3 x #8 x 1-1/4" truss head screws	

2.2 Loudspeaker Amplifier Setup

Set up and configure each loudspeaker amplifier *before* you mount it.

CyberData delivers each loudspeaker amplifier with the factory default values indicated in [Table 2-2](#):

Table 2-2. Factory Default Settings

Parameter	Factory Default Setting
IP Addressing	static
IP Address	192.168.3.10
Web Access Username	admin
Web Access Password	admin
Subnet Mask	255.255.255.0
Default Gateway	192.168.3.1

2.2.1 Loudspeaker Amplifier Components

[Figure 2-3](#) shows the components of the loudspeaker amplifier (PoE).

Figure 2-3. Loudspeaker Amplifier Components—PoE

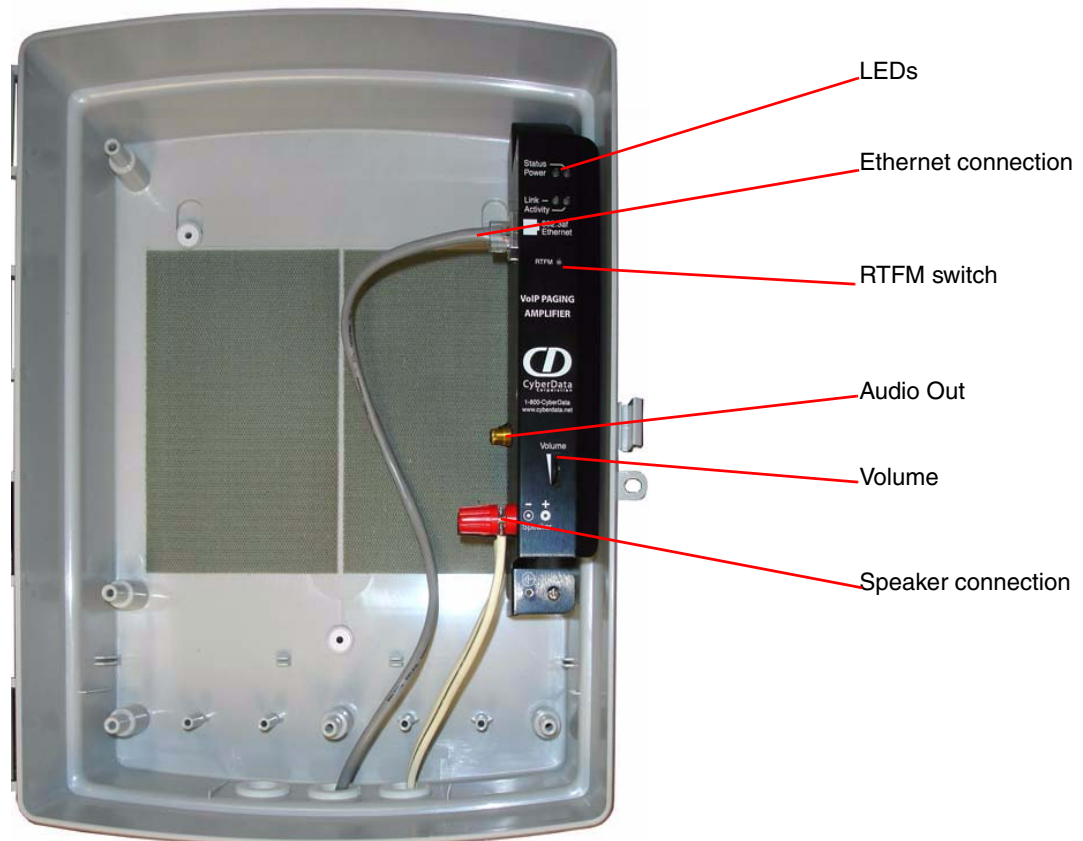

2.2.2 Loudspeaker Amplifier Jumpers

See [Figure 2-4](#) to identify the jumper and component locations.

Figure 2-4. Jumper Locations

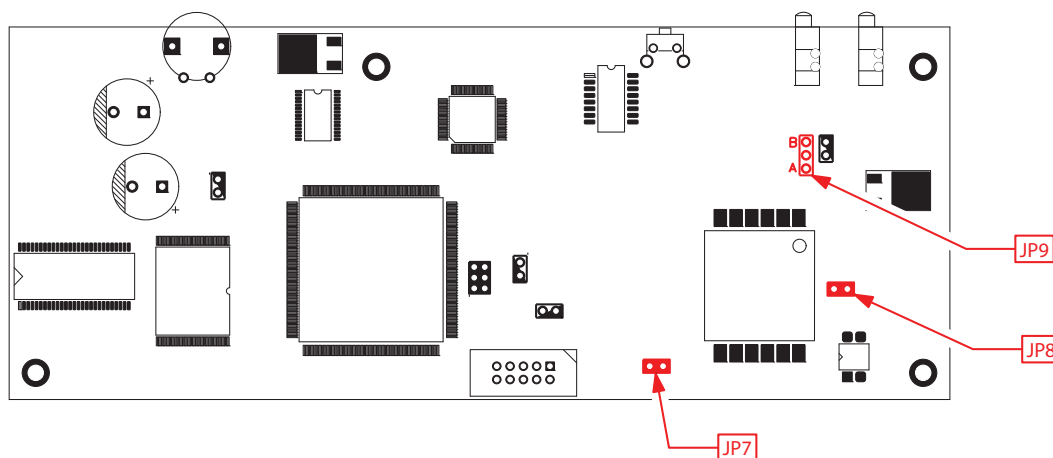

See [Table 2-3](#) and [Table 2-4](#) for the jumper settings.

Table 2-3. Jumper Settings—Low Power—802.3af Compliant (Default)

Jumper	Setting
JP7	OFF -> Low Power (21V)
JP8	OFF -> Low Power (21V)
JP9	Position B -> Low Power

Table 2-4. Jumper Settings—High Power—Non-PoE Compliant

Jumper	Setting
JP7	ON -> High Power (21V)
JP8	ON -> High Power (21V)
JP9	Position A -> High Power

2.2.3 Connect the Loudspeaker Amplifier

Figure 2-5 illustrates how to connect the VoIP Loudspeaker Amplifier (PoE).

Figure 2-5. Connect a Loudspeaker

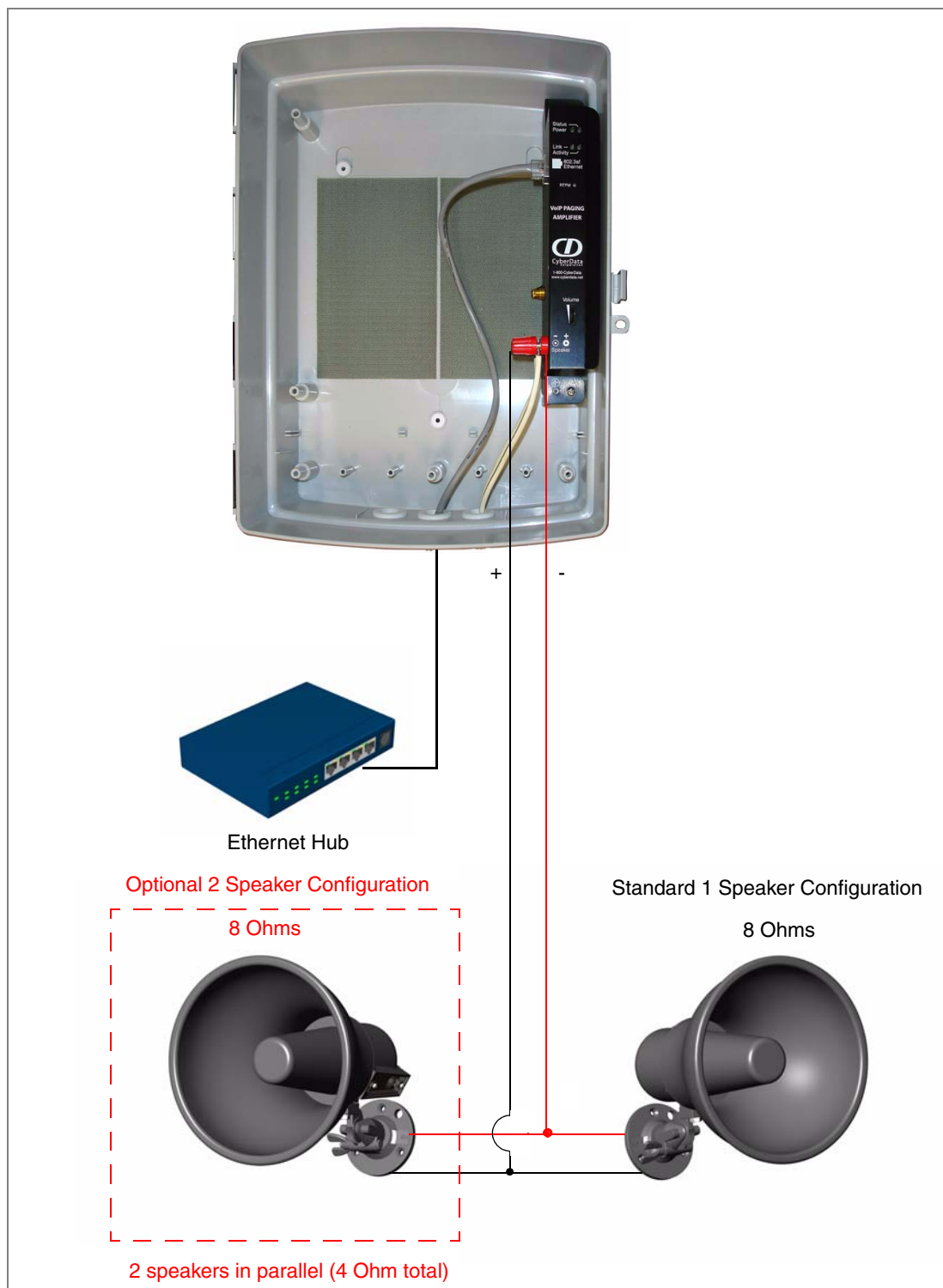

See [Table 2-5](#) for details about connecting the loudspeaker amplifier.

Table 2-5. Loudspeaker Amplifier Connections

Connection	Connection Details	Location
Loudspeaker	<ul style="list-style-type: none"> Use two binding posts for up to 0.083 inch diameter loudspeaker wire. 	VoIP paging amplifier
Ethernet	<ul style="list-style-type: none"> Use a RJ 45 cable. 	VoIP paging amplifier
AC ^a	<ul style="list-style-type: none"> For a phase connection, use a press-down connector for 14 AWG solid copper wire. For a neutral connection, use a press-down connector for 14 AWG solid copper wire. For an earth/ground connection, use a screw-down connector for 14 AWG solid copper wire. 	AC panel

a. Prior to installation, consult local building/electrical code requirements.

2.2.3.1 Using the Line Out Output

Figure 2-6. Using the Line Out Output

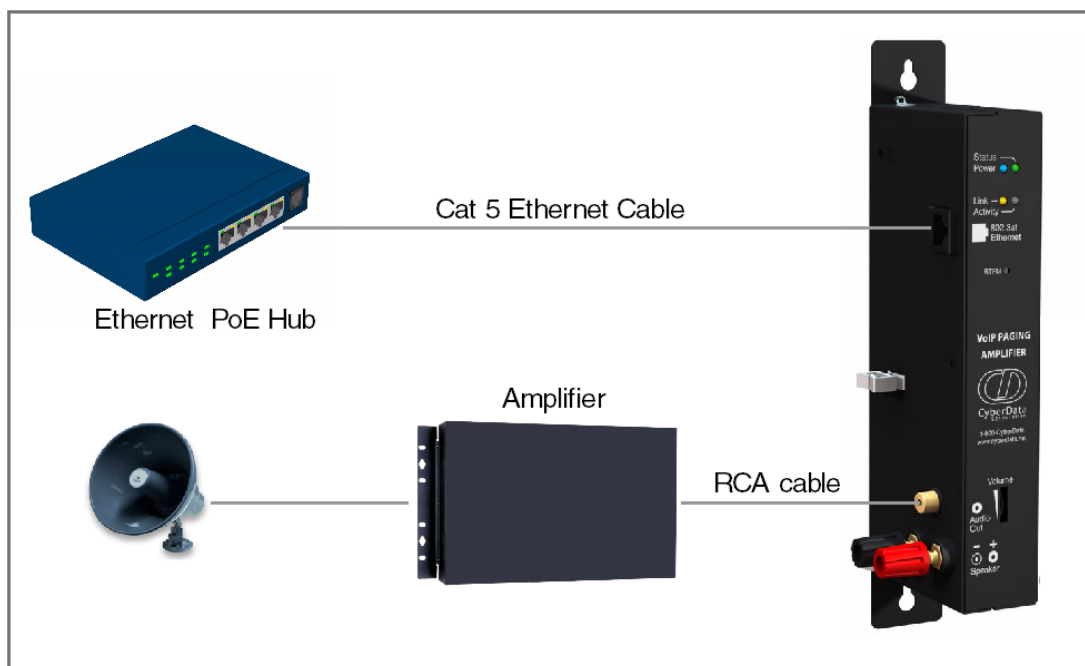

2.2.3.2 Loudspeaker Type

The CyberData VoIP Loudspeaker Amplifier supports an 8 Ohm Bogen or equivalent unamplified loudspeaker. See [Figure 2-7](#).

Figure 2-7. Hornspeaker



2.2.3.3 Cabling/Wiring

You may connect a loudspeaker to a loudspeaker amplifier with a good quality speaker cable that is limited to 25 feet in length.

For maximum output, use two 8-Ohm speakers that are wired in parallel with the shortest possible cable length (total combined length should not exceed more than 25 feet).

Note Prior to installation, consult local building/electrical code requirements.

2.2.4 Confirm Operation

After connecting the loudspeaker amplifier to the ethernet hub, use the LEDs on the loudspeaker amplifier face to confirm that the loudspeaker amplifier is operational and linked to the network.

Figure 2-8. Loudspeaker Amplifier LEDs—Power and Link

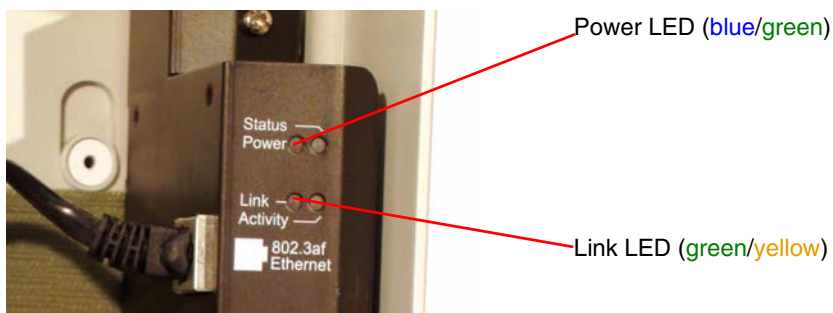

Figure 2-9. Loudspeaker Amplifier LEDs—Status and Activity

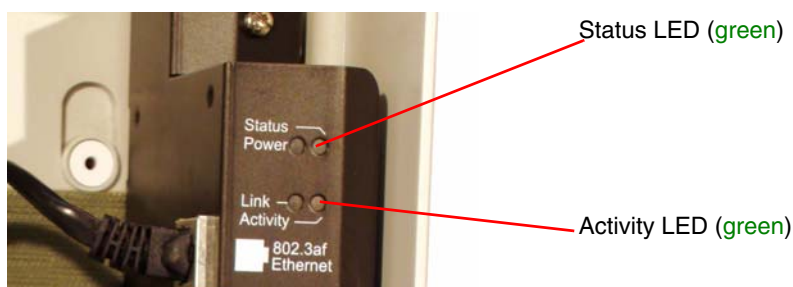

Table 2-6. Loudspeaker Amplifier LEDs

LED	Color	Function
Power	Blue/Green	The power LED is illuminated a steady blue when the power is on and blue/green when the amplifier is in the high power mode.
Status	Green	After supplying power to the loudspeaker amplifier: <ol style="list-style-type: none"> 1. The green Status LED illuminates after approximately five seconds to indicate the start of the firmware verification and load process. 2. After approximately 15 seconds, the Status LED begins to blink at one second intervals to indicate the start of the firmware boot process. 3. After approximately 35 seconds, the loudspeaker amplifier beeps once to indicate that it is operational. 4. The Status LED will continue to blink at one second intervals to indicate normal operation.
Link	Green/Yellow	The Link LED is illuminated green for a 10Mb link or yellow/green for a 100Mb link when the network link to the loudspeaker amplifier is established.
Activity	Green	The Activity LED blinks to indicate network traffic.

2.2.5 Confirm the IP Address, Test the Audio, and Check the Volume

When the loudspeaker amplifier is operational and linked to the network, use the Reset Test Function Management (**RTFM**) switch (Figure 2-10) on the loudspeaker amplifier face to announce and confirm the loudspeaker amplifier's IP Address, test that the audio is working, and check the volume.

Figure 2-10. RTFM Switch

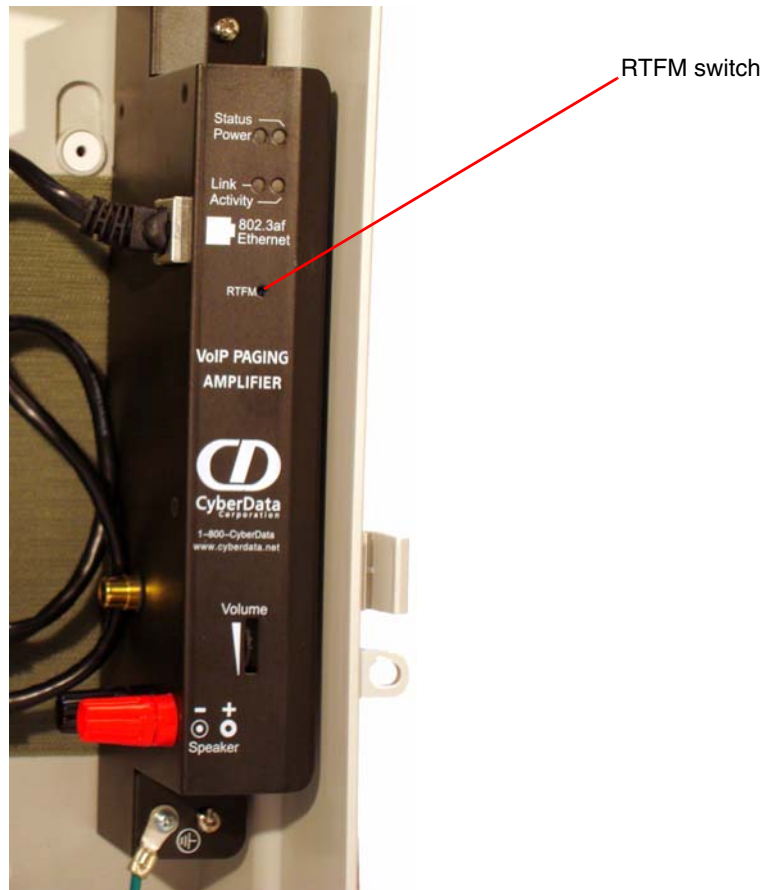

To announce a loudspeaker amplifier's current IP address:

1. Press and hold the **RTFM** switch until it beeps (after one second).
2. Release the switch to hear the IP address announcement, and check the loudspeaker amplifier volume.



Caution

Equipment Caution: Pressing and holding the RTFM switch for longer than 20 seconds will restore the loudspeaker amplifier to the factory default settings. See [Section 2.6, "Restore the Factory Default Settings"](#).

2.2.6 Adjust the Volume

To adjust the loudspeaker amplifier volume, turn the **Volume** dial (Figure 2-11) on the loudspeaker amplifier face.

Figure 2-11. Volume Control

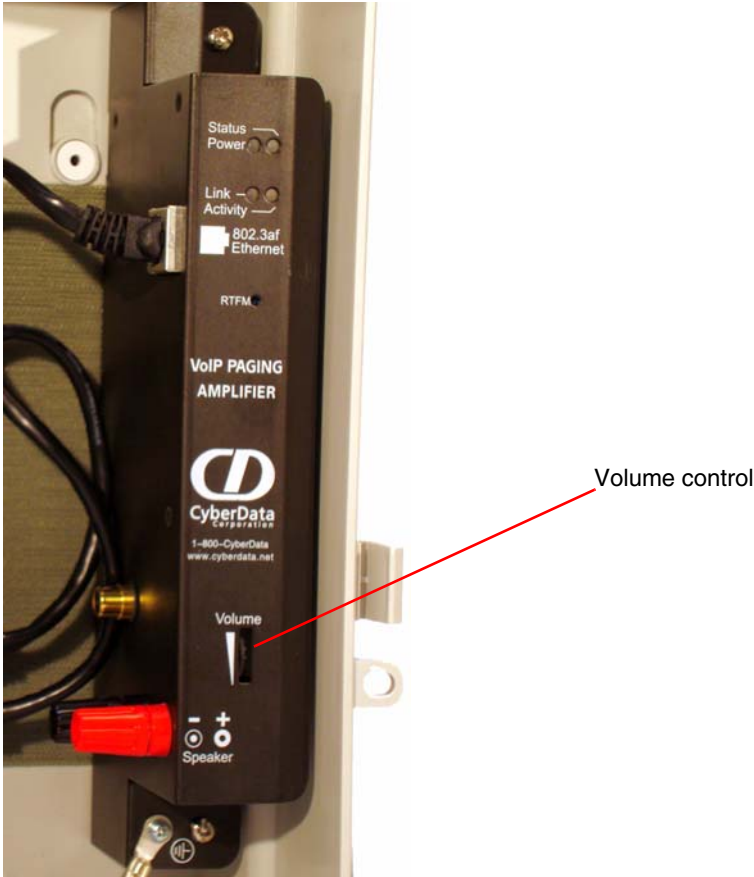

2.3 Configure the Loudspeaker Amplifier Parameters

To configure the loudspeaker amplifier online, use a standard web browser.

Configure each loudspeaker amplifier and verify its operation *before* you mount it. When you are ready to mount a loudspeaker amplifier enclosure, refer to [Chapter A, “Mounting the Enclosure”](#) for instructions.

All loudspeaker amplifiers are initially configured with the default IP settings indicated in [Table 2-7](#).

When configuring more than one loudspeaker amplifier, attach the loudspeaker amplifiers to the network one at a time to avoid IP address conflicts.

Table 2-7. Factory Default Settings

Parameter	Factory Default Setting
IP Addressing	static
IP Address	192.168.3.10
Web Access Username	admin
Web Access Password	admin
Subnet Mask	255.255.255.0
Default Gateway	192.168.3.1

2.3.1 Log in to the Configuration Home Page

1. Open your browser to the speaker IP address.

For the initial configuration of the speaker, open your browser to the default IP address:

<http://192.168.3.10>

Note Make sure that the PC is on the same IP network as the loudspeaker amplifier.

2. When prompted, use the following default **Web Access Username** and **Web Access Password** to access the **Home Page** ([Figure 2-12](#)):

Web Access Username: **admin**

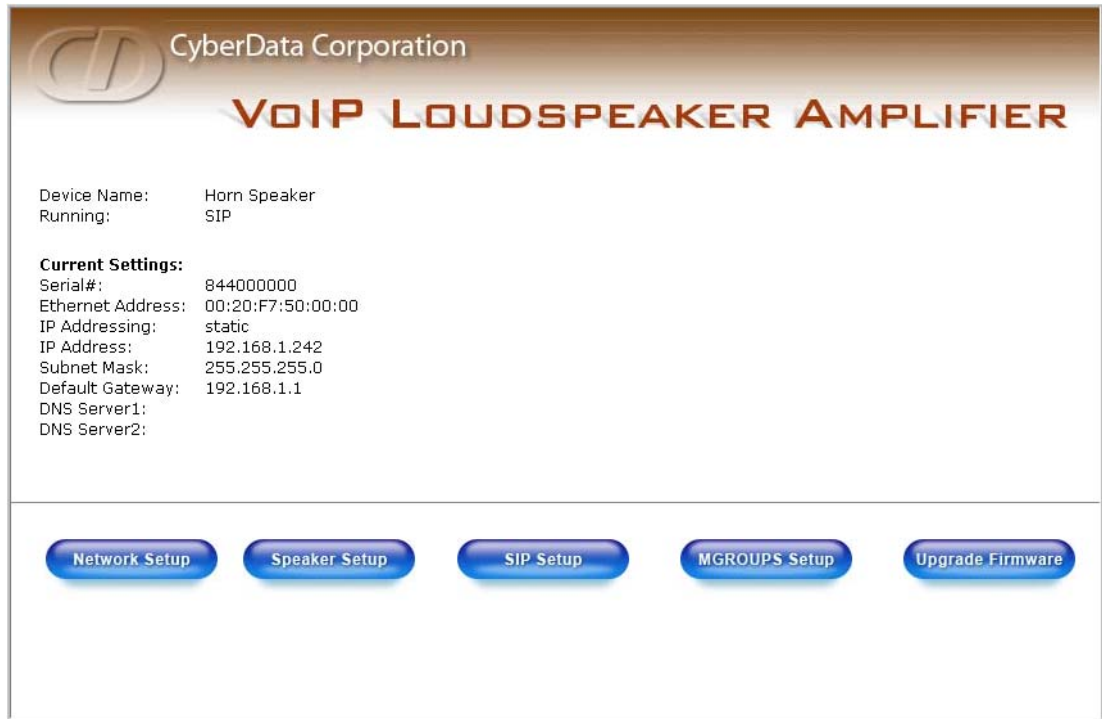

Web Access Password: **admin**

Figure 2-12. Home Page

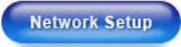

3. On the **Home Page**, review the setup details and navigation buttons described in [Table 2-8](#).

Table 2-8. Home Page Overview

Web Page Item	Description
Device Name	Shows the device name.
Running	Shows the current speaker function.
Serial #	Device serial number.
Ethernet Address	Device ethernet address.
IP Addressing	Shows the current IP addressing setting (DHCP or static).
IP Address	Shows the current IP address.
Subnet Mask	Shows the current subnet mask address.
Default Gateway	Shows the current default gateway address.
	Link to the Speaker Setup page.
	Link to the Network Setup page.
	Link to the SIP Setup page.
	Link to the MGROUPS Setup page.

- 16 Installing the VoIP Loudspeaker Amplifier
Configure the Loudspeaker Amplifier Parameters

Table 2-8. Home Page Overview (continued)

Web Page Item	Description
	Link to the Upgrade Firmware web page.

2.3.2 Configure the Network Parameters

1. Click the **Network Setup** button to open the **Network Setup** page (Figure 2-13).

Figure 2-13. Network Setup Page

2. On the **Network Setup** page, enter values for the parameters indicated in Table 2-9.

Table 2-9. Network Setup Parameters







Web Page Item	Description
IP Addressing*	Select either DHCP IP Addressing or Static IP Addressing by marking the appropriate radio button. If you select Static , configure the remaining parameters indicated in Table 2-9. If you select DHCP , go to Step 3.
IP Address*	Enter the static IP address.
Subnet Mask	Enter the Subnet Mask address.
Default Gateway	Enter the Default Gateway address.
DNS Server 1*	Enter the DNS Server 1 address.
DNS Server 2*	Enter the DNS Server 2 address.
	Click this button to save your configuration settings. Changing a parameter that has an asterisk next to it will cause a system reboot when saved.

Table 2-9. Network Setup Parameters (continued)

Web Page Item	Description
	Link to the Speaker Setup page.
	Link to the SIP Setup page.
	Link to the MGROUPS Setup page.
	Link to the Upgrade Firmware page.
	Link to the Home page.

3. After changing the parameters, click **Save Settings**. This updates the changed parameters and reboots the speaker if appropriate.
4. Connect the speaker to the target network.
5. From a system on the same network as the speaker, open a browser with the new IP address of the speaker.

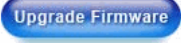
2.3.3 Set up the Loudspeaker Amplifier

1. Click the **Speaker Setup** button to open the **Speaker Setup** page. See [Figure 2-14](#)

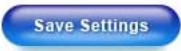

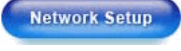

Figure 2-14. Loudspeaker Amplifier Setup

2. On the **Loudspeaker Amplifier Setup** page, enter values for the parameters indicated in [Table 2-10](#).

Table 2-10. Loudspeaker Amplifier Setup Parameters

Web Page Item	Description
Device Name	Enter a descriptive name for this device (if desired).
Select Speaker Function	Select SIP or MGROUPS.
Change Web Access Username	Use this field to change the Web Access Username.
Change Web Access Password	Use this field to change the Web Access Password.
Re-enter New Password	Use this field to re-enter a new password.
Speaker Tone Before Paging	Enable/Disable the speaker tone (beep) before each page.
Speaker Tone After Initialization	Enable/Disable the speaker tone (beep) after the system startup.

Table 2-10. Loudspeaker Amplifier Setup Parameters (continued)

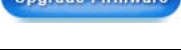
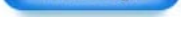
Web Page Item	Description
RTFM Announcement ^a	Enable/Disable the speaker tone (beep) and audio associated with the RTFM switch.
	Click on this button to save your configuration settings. Changing a parameter that has an asterisk next to it will cause a system reboot when saved.
	Click on this button to do an audio test. Generates a voice message for testing the speaker audio quality and volume.
	Link to the Network Setup page.
	Link to the SIP Setup page.
	Link to the MGROUPS Setup page.
	Link to the Upgrade Firmware page.
	Link to the Home Page page.

a.If you select **No** for **RTFM Announcement**, you will not hear a beep or associated RTFM audio. However, the return to default settings function remains active. If you wish to return to default settings, hold the RTFM button at least 20 seconds, then release the button.

3. After changing the parameters, click **Save Settings**.

2.3.4 Configure the SIP Parameters

1. Click **SIP Setup** to open the **SIP Setup** page (Figure 2-15).

Note For specific server configurations, go to the following URL:

<http://www.cyberdata.net/support/voip/index.html>

Figure 2-15. SIP Setup Page

CyberData Corporation
VOIP LOUDSPEAKER AMPLIFIER

SIP Setup

SIP Server: *

Outbound Proxy: *

Remote SIP Port: *

Local SIP Port: *

SIP User ID: *

Authenticate ID: *

Authenticate Password: *

SIP Registration: Yes No *

Unregister on Reboot: Yes No *

Register Expiration (minutes): *



** changing this parameter causes system reboot when saved*

[Save Settings](#)

[Network Setup](#) [Speaker Setup](#) [MGROUPS Setup](#) [Upgrade Firmware](#) [Home Page](#)

2. On the **SIP Setup** page, enter values for the parameters indicated in [Table 2-11](#).

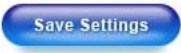
Table 2-11. SIP Setup Parameters

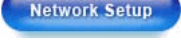
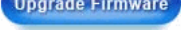
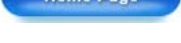
Web Page Item	Description
SIP Server*	Enter the SIP server represented as either a numeric IP address in dotted decimal notation or the fully qualified host name (FQHN) up to 64 characters.
Outbound Proxy	Enter the Outbound Proxy as either a numeric IP address in dotted decimal notation or the fully qualified host name (FQHN) up to 64 characters.
Remote SIP Port*	Enter the Remote SIP Port number (default 5060).
Local SIP Port*	Enter the Local SIP Port number (default 5060).
SIP User ID*	Enter the SIP User ID (up to 25 alphanumeric characters).
Authenticate ID*	Enter the Authenticate ID (up to 25 alphanumeric characters).
Authenticate Password*	Enter the Authenticate Password (up to 25 alphanumeric characters).
SIP Registration*	Enable/Disable SIP Registration.
Unregister on Reboot*	<ul style="list-style-type: none"> • Select Yes to automatically unregister the paging amplifier when it is rebooted. • Select No to keep the paging amplifier registered when it is rebooted.
Register Expiration*	Enter the SIP Registration lease time in minutes (default 60 minutes).
	Click this button to save your configuration settings. Changing a parameter that has an asterisk next to it will cause a system reboot when saved.
	Link to the Speaker Setup page.
	Link to the MGROUPS Setup page.
	Link to the Network Setup page.
	Link to the Upgrade Firmware page.
	Link to the Home page.

3. After changing the parameters, click **Save Settings**.

2.4 Set up the MGROUPS

MGROUPS uses multicasting to create Public Address Paging Zones. Multicasting is based on the concept of a group. Multicast addresses specify an arbitrary group of IP hosts that have joined the group and want to receive traffic sent to the group. Group members send IGMP messages to their local multicast routers, allowing the group traffic traversal from the source.

MGROUPS Setup provides the ability to join up to 10 Paging Zones. A Paging Zone can consist of one, or many, CyberData MGROUPS-enabled speakers. There is no limit to how many speakers can be in a given Paging Zone. Each MGROUP is defined by a multicast address and port number. Each MGROUP is also assigned a priority, allowing simultaneously arriving pages to be serviced based on importance. MGROUPS are compatible with IGMP through version 3.

1. Click on the **MGROUPS Setup** button to open the **MGROUPS Setup** page. See [Figure 2-16](#).

Figure 2-16. MGROUPS Setup

CyberData Corporation
VOIP LOUDSPEAKER AMPLIFIER

MGROUPS Setup

Device Name: Horn Speaker

	Multicast IP Address	Port: 2000-65535	Priority: High	MGROUP Name	Beep
MG-Emergency	239.168.3.01	2000	9	Alarm	<input checked="" type="checkbox"/>
MG-1	239.168.3.02	2000	1	Ext. 123, Cafeteria	<input type="checkbox"/>
MG-2	239.168.3.03	2000	2	Ext. 124, Manufacturing	<input type="checkbox"/>
MG-3	239.168.3.04	2000	3	Ext. 125, Main Lobby	<input type="checkbox"/>
MG-4	239.168.3.05	2000	4	Ext. 126, Main Auditorium	<input type="checkbox"/>
MG-5	239.168.3.06	2000	5	Ext. 127, Conference Rm 1	<input type="checkbox"/>
MG-6	239.168.3.07	2000	6	Ext. 128, Conference Rm 2	<input type="checkbox"/>
MG-7	239.168.3.08	2000	7	Ext. 129, Conference Rm 3	<input type="checkbox"/>
MG-8	239.168.3.09	2000	8	Ext. 130, Conference Rm 4	<input type="checkbox"/>

	Multicast IP Address	Port: 2000-65535	Priority: Low	MGROUP Name	Beep
MG-Background	239.168.3.10	2000	0	Background Music	<input type="checkbox"/>







Save Settings Reboot

must reboot for changes to take effect

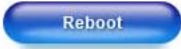
Network Setup Speaker Setup SIP Setup Upgrade Firmware Home Page

2. On the **MGROUPS Setup** page, enter values for the parameters indicated in [Table 2-12](#).

Table 2-12. MGROUPS Setup Parameters

Web Page Item	Description
Device Name	Displays the device name.
MG-Emergency	Use MG-Emergency for the MGROUP with the highest priority.
MG-(1-8)	Use MG-(1-8) to assign MGROUPS 1 through 8.
MG-Background	Use MG-Background for the MGROUP with the lowest priority (background audio for example).
Multicast IP Address	Enter the multicast IP Address for this MGROUP.
Port 2000-65535	Enter the port number for this MGROUP.
Priority	Assign the priority to a MGROUP (the higher the number, the higher the priority).
MGROUP Name	Assign a descriptive name for this MGROUP.
Beep	Check this box if you want a beep to precede a page.
	Click this button to save your configuration settings.
	Click this button to reboot the system.
	Link to the Network Setup page.
	Link to the Speaker Setup page.
	Link to the SIP Setup page.
	Link to the Upgrade Firmware page.
	Link to the Home page.

3. After changing the parameters, click **Save Settings**.

2.5 Upgrade the Firmware and Reboot the Loudspeaker Amplifier

To upload the speaker firmware from your PC:

1. Set up a TFTP server.
If you do not already have a TFTP server running on your network, see [Chapter B, "Setting up a TFTP Server"](#).
2. Retrieve the latest speaker firmware from the CyberData website:
<http://www.cyberdata.net/support/voip/index.html>
3. Unzip the speaker version file. This file may contain the following:
 - Kernel firmware file: xxx-image-xxx-xxx.bin
 - Application firmware file: xxx-romdisk-xxx-xxx.img
 - Release notes
4. Copy the firmware files to be upgraded to the appropriate TFTP server directory:
 - c:\tftp-root\ (for Windows)
 - /tftpboot/ (for Linux)
5. Log in to the speaker home page as instructed in [Section 2.3.1, "Log in to the Configuration Home Page"](#).
6. Click the **Upgrade Firmware** button to open the **Firmware Upgrade** page. See [Figure 2-17](#).

Figure 2-17. Firmware Upgrade Page

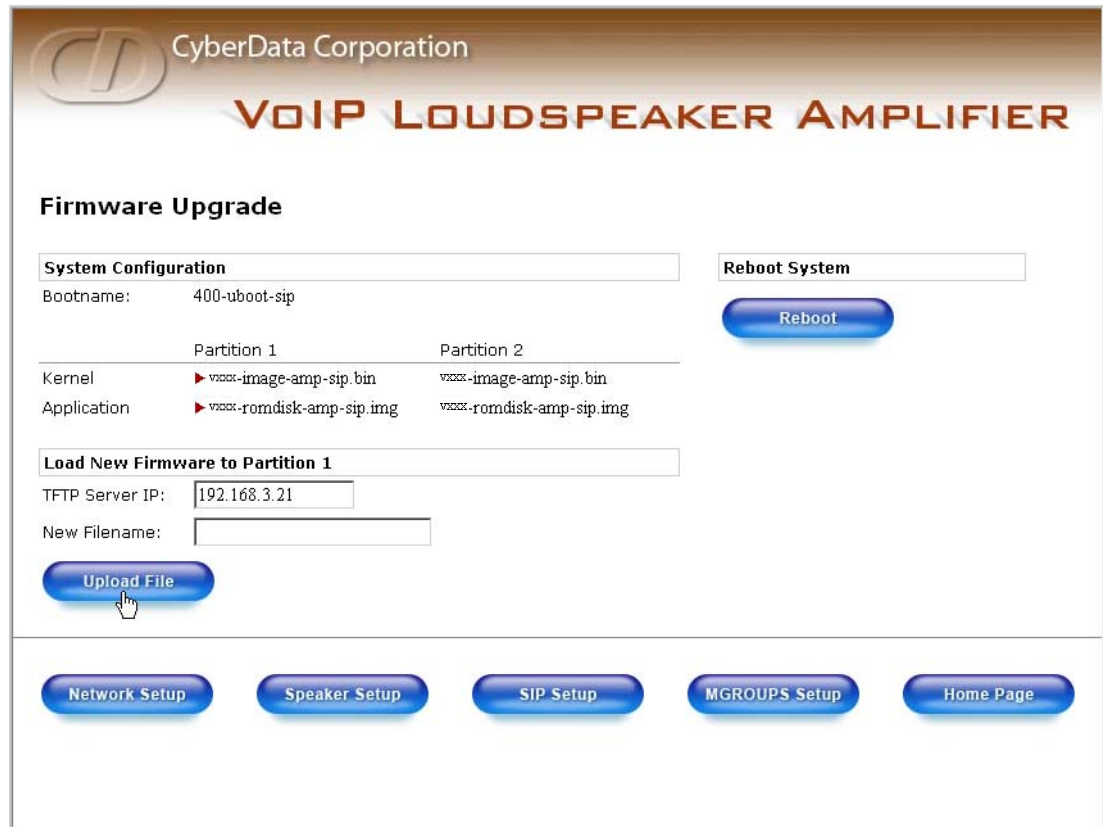

7. Enter the IP address of your TFTP server into the **TFTP Server IP** parameter field.
8. Enter the firmware filename of the file to be uploaded into the **New Filename** parameter field. For example, kernel filename "201-image-spk-sip.bin".
9. Click **Upload File**.

Note This starts the upload process. Once the speaker has uploaded the file, the **Uploading Firmware** countdown page appears, indicating that the firmware is being written to flash. The speaker will automatically reboot when the upload is complete. When the countdown finishes, the **Firmware Upgrade** page will refresh. The uploaded firmware filename should be displayed in the system configuration (indicating successful upload and reboot).





10. Repeat steps 8 and 9 if you are uploading the **Kernel** and **Application** files. For example, **Application** filename "201-romdisk-spk-sip.img".

Table 2-13 shows the web page items on the **Firmware Upgrade** page.

Table 2-13. Firmware Upgrade Parameters

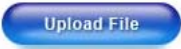
Web Page Item	Description
System Configuration	Shows the current configuration.
Bootname	Shows the current boot loader filename.
Kernel	Shows the current kernel filename for partition 1 and 2.

Table 2-13. Firmware Upgrade Parameters (continued)

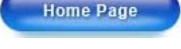
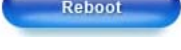
Web Page Item	Description
Application	Shows the current application filename for partition 1 and 2.
Load new firmware to Partition 1	Enter the TFTP Server IP address.
New Filename	Enter the new file name for the kernel or application firmware file that you are uploading.
	Click on this button to automatically upload the selected firmware and reboot the system.
	Link to the Speaker Setup page.
	Link to the Network Setup page.
	Link to go to the SIP Setup page.
	Link to the MGROUPS Setup page.
	Link to the Home page.
	Click on this button to reboot the system.

2.5.1 Reboot the Loudspeaker Amplifier

To reboot a loudspeaker amplifier, log in to the web page as instructed in [Section 2.3.1, "Log in to the Configuration Home Page"](#).

1. Click **Upgrade Firmware** to open the **Firmware Upgrade** page ([Figure 2-18](#)). Use the **Reboot System** section on the right side of the page.

Figure 2-18. Reboot System Section

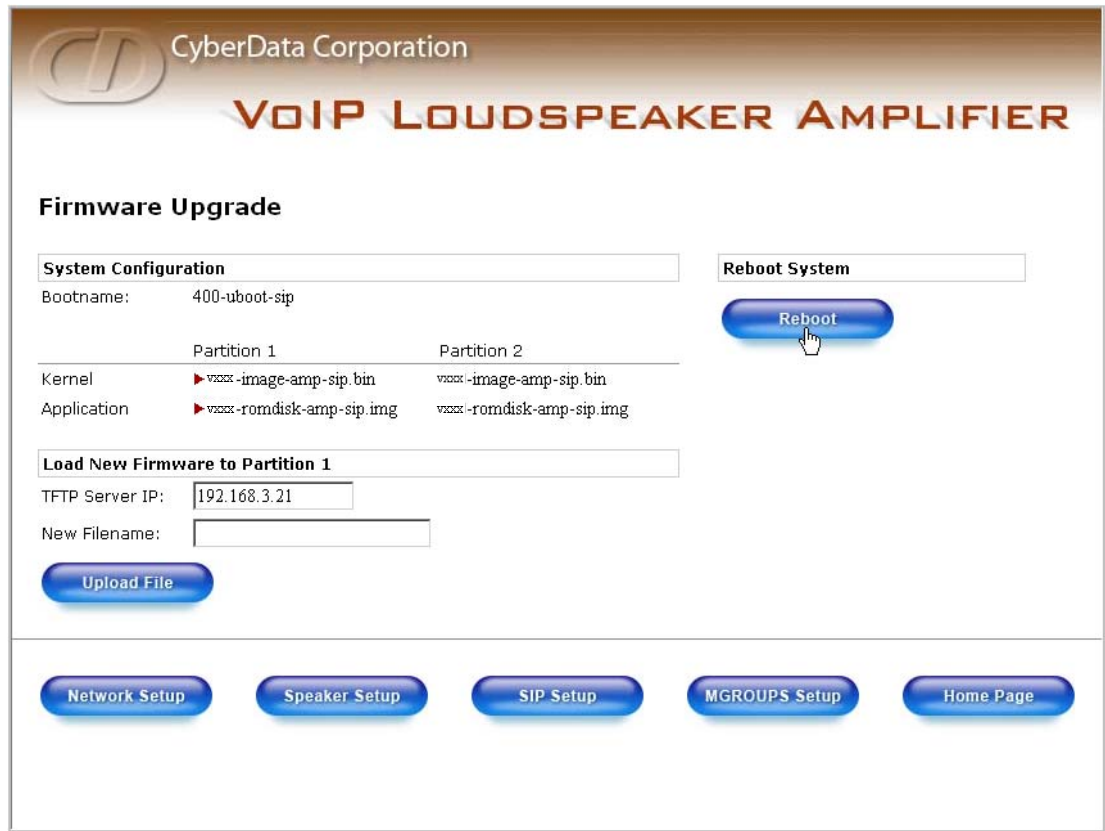

2. Click **Reboot**. A normal restart will occur as per the Status LED section of [Table 2-6](#).

2.6 Restore the Factory Default Settings

When troubleshooting configuration problems, it is sometimes convenient to restore the device to a known state.

Each loudspeaker amplifier is delivered with factory set default values for the parameters indicated in [Table 2-14](#). Use the **RTFM** switch on the loudspeaker amplifier face to restore these parameters to the factory default settings.

When you use the RTFM switch, the factory default settings are restored for *only* the parameters indicated in [Table 2-14](#). The other parameters in the current loudspeaker amplifier configuration will remain unchanged.

Table 2-14. Factory Default Settings

Parameter	Factory Default Setting
IP Addressing	static
IP Address	192.168.3.10
Web Access Username	admin
Web Access Password	admin
Subnet Mask	255.255.255.0
Default Gateway	192.168.3.1

To restore these parameters to the factory default settings:

1. Press and hold the RTFM switch for 20 seconds.
2. The loudspeaker amplifier will beep after one second. Continue to hold the switch until the loudspeaker amplifier beeps again after 20 seconds.
3. Release the switch. The following occurs:
 - A voice message announces that the factory default settings are being restored.
 - Once the settings are restored, a voice message announces the restored default IP address:
`192.168.3.10`
 - A voice message announces that the loudspeaker amplifier is rebooting.
 - The loudspeaker amplifier reboots.

30 Installing the VoIP Loudspeaker Amplifier
Restore the Factory Default Settings

Appendix A: Mounting the Enclosure

A.0 Mount the Enclosure

Before you mount the enclosure, make sure that you have received all of the parts for each enclosure. Refer to [Table A-15](#).

Table A-15. Wall Mounting Components (Part of the Accessory Kit)

Quantity	Part Name	Illustration
3	#8 Sheet Metal Screws	

Note The loudspeaker amplifier was designed for indoor use. Mounting it on the external part of a building will require additional hardware for weatherproofing, cabling access, and lightning suppression. Consult a certified electrician for details.

See [Figure A-1](#) to mount the enclosure.

Note For mounting, use the three **#8 SHEET METAL SCREWS** to secure the enclosure.

Figure A-1. Loudspeaker Amplifier Enclosure Assembly

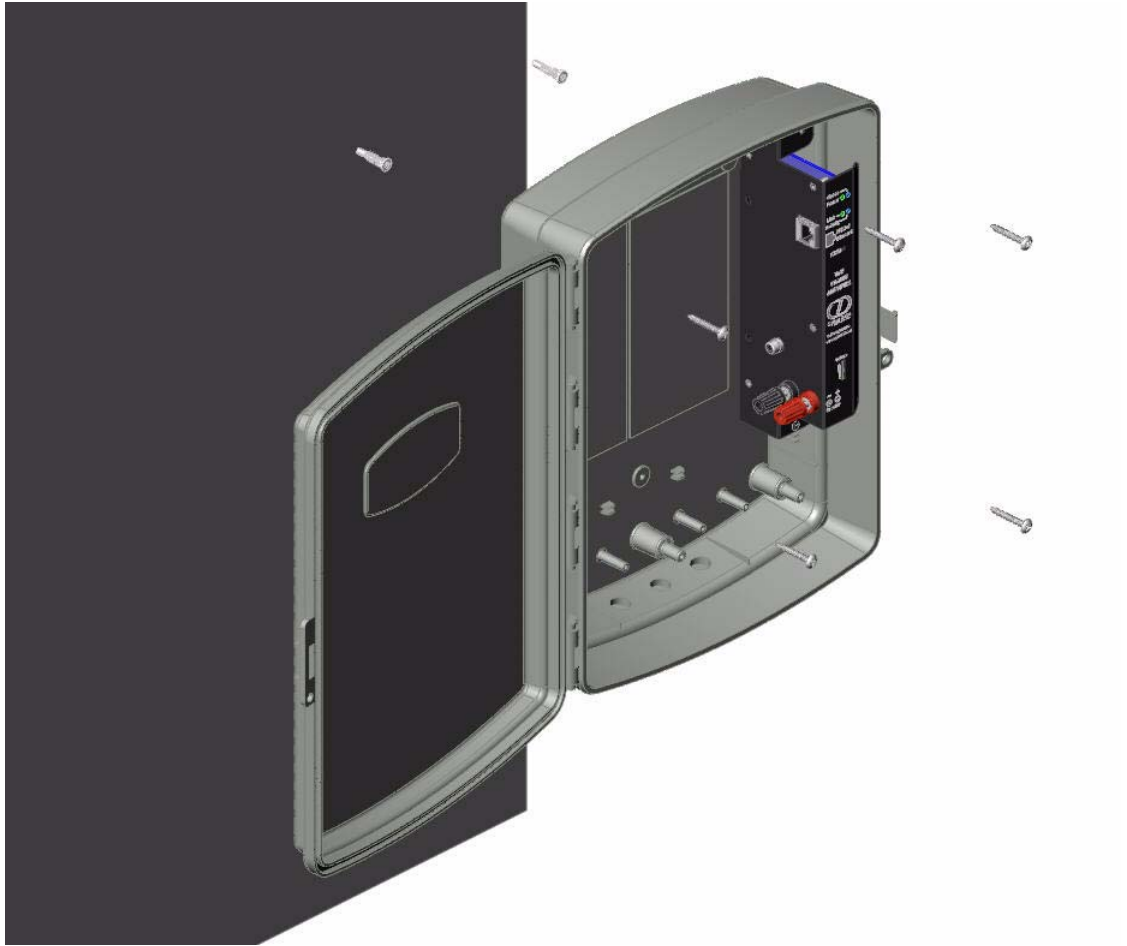

Appendix B: Setting up a TFTP Server

B.0 Set up a TFTP Server

Upgrading the VoIP Loudspeaker Amplifier firmware requires a TFTP server on which you access the Web interface where you can upload the firmware files.

B.0.1 In a LINUX Environment

To set up a TFTP server on LINUX:

1. Create a directory dedicated to the TFTP server, and move the files to be uploaded to that directory.
2. Run the following command where `/tftpboot/` is the path to the directory you created in [Step 1](#): the directory that contains the files to be uploaded. For example:

```
in.tftpd -l -s /tftpboot/your_directory_name
```

B.0.2 In a Windows Environment

You can find several options online for setting up a Windows TFTP server. This example explains how to use the Solarwinds freeware TFTP server, which you can download at:

<http://www.cyberdata.net/support/voip/index.html>

To set up a TFTP server on Windows:

1. Install and start the software.
2. Select **File/Configure/Security** tab/**Transmit Only**.
3. Make a note of the default directory name, and then move the firmware files to be uploaded to that directory.
4. You can find several options online for setting up a Solarwinds server. This example explains how to use the Solarwinds freeware TFTP server, which you can download at:

<http://www.cyberdata.net/support/voip/index.html>

Appendix C: Troubleshooting/Technical Support

C.1 Frequently Asked Questions (FAQ)

Go to the following URL to see CyberData's list of frequently asked questions:

<http://www.cyberdata.net/support/voip/index.html>

C.2 Documentation

The documentation for this product is released in an English language version only. You can download PDF copies of CyberData product documentation at:

<http://www.cyberdata.net/support/voip/index.html>

C.3 Contact Information

Contact	<p>CyberData Corporation 2555 Garden Road Monterey, CA 93940 USA www.CyberData.net Phone: 800-CYBERDATA (800-292-3732) Fax: 831-373-4193</p>
Sales	Sales (831) 373-2601 Extension 334
Technical Support	<p>Phone: 831-373-2601 Extension 333 Email: support@CyberData.net</p>
Returned Materials Authorization	<p>To return the product, contact the CyberData Returned Materials Authorization (RMA) department at:</p> <p>Phone: 831-373-2601, Extension 136 Email: RMA@CyberData.net</p> <p>When returning a product to CyberData, an approved CyberData RMA number must be printed on the outside of the original shipping package. No product will be accepted for return without an approved RMA number. Send the product, in its original package, to the following address:</p> <p>CyberData Corporation 2555 Garden Road Monterey, CA 93940 Attention: RMA "your RMA number"</p>

C.4 Warranty

CyberData warrants its product against defects in material or workmanship for a period of two years from the date of purchase. Should the product fail within the warranty period, CyberData will repair or replace the product free of charge. This warranty includes all parts and labor.

If the product is out-of-warranty and fails, a flat rate repair charge of one half the product purchase price will be assessed. Repair costs for products that are in warranty, but damaged by improper modifications or abuse, will be charged at the out-of-warranty rate. Products returned to CyberData, both in and out-of-warranty, are shipped to CyberData at the expense of the customer. Charges for shipping repaired products back to the customer will be paid by CyberData.

Index

Symbols

#8 sheet metal screws 31

Numerics

3 x #8 x 1-1/4" truss head screws 5

A

accessory kit 5
 activity LED 11
 address, configuration login 14
 announcing a loudspeaker amplifier's IP address 12
 asterisk 17, 20
 audio encodings 3
 audio line out 9

C

cablling
 length for maximum output 10
 changing
 the web access password 19
 configurable parameters 15, 17, 19, 22, 26
 configuration
 default IP settings 14
 network 17
 SIP 20
 using Web interface 14
 configuration home page 14
 CyberData contact information, corporate, sales, tech
 support, service 35

D

default
 gateway 6, 14, 29
 IP address 6, 14, 29
 loudspeaker amplifier settings 37
 subnet mask 6, 14, 29
 username and password 6, 14, 29
 web login username and password 14
 default gateway 6, 14, 17, 29

default IP settings 14
 default login address 14
 default loudspeaker amplifier settings 29
 DHCP Client 3
 DHCP IP addressing 17
 dimensions 3
 DNS server 17

E

enclosure, mounting 31
 expiration time for SIP server lease 22

F

factory default settings 29
 firmware upgrades 33

H

home page 14
 http web-based configuration 3

I

illustration of enclosure mounting process 31
 installation, typical loudspeaker amplifier system 1
 IP address 6, 14, 17, 29
 IP addressing 17

J

jumpers, settings 7

L

lease, SIP server expiration time 22
 LEDs 11
 line out output 9
 link LED 11
 Linux, setting up a TFTP server on 33

- local SIP port 22
- log in address 14
- loudspeaker amplifier configuration page
 - configurable parameters 19
- loudspeaker amplifier setup 19
- loudspeaker amplifier configuration
 - default IP settings 14
- loudspeaker amplifier configuration page
 - configurable parameters 15, 17, 22, 26
- loudspeaker amplifier operations, verifying 19
- loudspeaker, cabling/wiring 10
- loudspeaker, type 9

M

- MGROUP
 - MG-(1-8) 24
 - MG-Background 24
 - MG-Emergency 24
 - MGROUP Name 24
 - Multicast IP Address 24
- mounting an enclosure 31

N

- network configuration of loudspeaker amplifier 17
- network link activity, verifying 11
- Network Setup 17

O

- outbound proxy 22
- output 3

P

- packet time 3
- part number 3
- parts
 - #8 sheet metal screws 31
- parts list 5
- password
 - changing for web configuration access 19
 - for SIP server login 22
 - login 14
 - restoring the default 6, 14, 29
- port
 - local SIP 22
 - remote SIP 22

- port baud rate 3
- power LED 11
- power requirement 3
- power, connecting to loudspeaker amplifier 8
- product
 - configuring 14
 - mounting 31
 - parts list 5
- product features 2
- product overview
 - product features 2
 - product specifications 3
 - supported protocols 3
 - supported SIP servers 3
 - typical system installation 1
- product specifications 3
- protocols supported 3

R

- reboot 27, 29
- registration and expiration, SIP server lease 22
- remote SIP port 22
- reset test function management switch 12
- resetting the IP address to the default 31, 35
- restoring factory default settings 29, 37
- RMA returned materials authorization 35
- RTFM switch 12, 29
- RTP/AVP 3

S

- sensitivity 3
- server address, SIP 22
- setting up a TFTP server 33
- settings, default 29
- SIP (session initiation protocol) 3
- SIP Configuration 20
- SIP configuration
 - SIP Server 22
- SIP registration 22
- SIP server 22
 - SIP servers supported 3
- speakers
 - maximum output 10
- static IP addressing 17
- status LED 11
- subnet mask 6, 14, 17, 29
- supported protocols 3

T

- technical support, contact information 35
- TFTP server 3, 33
- truss head screws 5

U

- unregister, from SIP server 22
- user ID
 - for SIP server login 22
- user ID, SIP 22
- username
 - changing for web configuration access 19
 - default for web configuration access 14
 - restoring the default 6, 14, 29

V

- verifying
 - loudspeaker amplifier operations 19
 - network link and activity 11
 - power on to loudspeaker amplifier 11

W

- warranty 36
- web access password 6, 14, 29
- web access username 6, 14, 29
- web configuration log in address 14
- web-based loudspeaker amplifier configuration 14
- weight 3
- Windows, setting up a TFTP server on 33
- wiring 10
 - cable length 10
 - wiring and speakers for maximum output 10
- wiring, electrical code 10

