



VoIP Emergency Intercom Operations Guide

Part #011035
Document Part #930279A
for Firmware Version 3.3.2

CyberData Corporation
2555 Garden Road
Monterey, CA 93940
(831) 373-2601

PoE VoIP Intercom Operations Guide 930279A
Part # 011035

COPYRIGHT NOTICE:

© 2009, CyberData Corporation, ALL RIGHTS RESERVED.

This manual and related materials are the copyrighted property of CyberData Corporation. No part of this manual or related materials may be reproduced or transmitted, in any form or by any means (except for internal use by licensed customers), without prior express written permission of CyberData Corporation. This manual, and the products, software, firmware, and/or hardware described in this manual are the property of CyberData Corporation, provided under the terms of an agreement between CyberData Corporation and recipient of this manual, and their use is subject to that agreement and its terms.

DISCLAIMER: Except as expressly and specifically stated in a written agreement executed by CyberData Corporation, CyberData Corporation makes no representation or warranty, express or implied, including any warranty or merchantability or fitness for any purpose, with respect to this manual or the products, software, firmware, and/or hardware described herein, and CyberData Corporation assumes no liability for damages or claims resulting from any use of this manual or such products, software, firmware, and/or hardware. CyberData Corporation reserves the right to make changes, without notice, to this manual and to any such product, software, firmware, and/or hardware.

OPEN SOURCE STATEMENT: Certain software components included in CyberData products are subject to the GNU General Public License (GPL) and Lesser GNU General Public License (LGPL) "open source" or "free software" licenses. Some of this Open Source Software may be owned by third parties. Open Source Software is not subject to the terms and conditions of the CyberData COPYRIGHT NOTICE or software licenses. Your right to copy, modify, and distribute any Open Source Software is determined by the terms of the GPL, LGPL, or third party, according to who licenses that software.

Software or firmware developed by CyberData that is unrelated to Open Source Software is copyrighted by CyberData, subject to the terms of CyberData licenses, and may not be copied, modified, reverse-engineered, or otherwise altered without explicit written permission from CyberData Corporation.



TRADEMARK NOTICE: CyberData Corporation and the CyberData Corporation logos are trademarks of CyberData Corporation. Other product names, trademarks, and service marks may be the trademarks or registered trademarks of their respective owners.





Phone: (831) 373-2601
Technical Support Ext. 333
support@cyberdata.net
Fax: (831) 373-4193
Company and product information at www.cyberdata.net

Important Safety Instructions

1. Read these instructions.
2. Keep these instructions.
3. Heed all warnings.
4. Follow all instructions.
5. Do not use this apparatus near water.
6. Clean only with dry cloth.
7. Do not block any ventilation openings. Install in accordance with the manufacturer's instructions.
8. Do not install near any heat sources such as radiators, heat registers, stoves, or other apparatus (including amplifiers) that produce heat.
9. Do not defeat the safety purpose of the polarized or grounding-type plug. A polarized plug has two blades with one wider than the other. A grounding type plug has two blades and a third grounding prong. The wide blade or the third prong are provided for your safety. If the provided plug does not fit into your outlet, consult an electrician for replacement of the obsolete outlet.
10. Protect the power cord from being walked on or pinched particularly at plugs, convenience receptacles, and the point where they exit from the apparatus.
11. Only use attachments/accessories specified by the manufacturer.
12. Refer all servicing to qualified service personnel. Servicing is required when the apparatus has been damaged in any way, such as power-supply cord or plug is damaged, liquid has been spilled or objects have fallen into the apparatus, the apparatus has been exposed to rain or moisture, does not operate normally, or has been dropped.
13. Prior to installation, consult local building and electrical code requirements.
14. **WARNING: The VoIP Intercom enclosure is not rated for any AC voltages!**

 <p>GENERAL ALERT</p>	<p>Warning</p> <p><i>Electrical Hazard:</i> This product should be installed by a licensed electrician according to all local electrical and building codes.</p>
 <p>GENERAL ALERT</p>	<p>Warning</p> <p><i>Electrical Hazard:</i> To prevent injury, this apparatus must be securely attached to the floor/wall in accordance with the installation instructions.</p>

Pictorial Alert Icons

	<p>General Alert</p> <p><i>This pictorial alert indicates a potentially hazardous situation. This alert will be followed by a hazard level heading and more specific information about the hazard.</i></p>
	<p>Ground</p> <p><i>This pictorial alert indicates the Earth grounding connection point.</i></p>

Hazard Levels

Danger: Indicates an imminently hazardous situation which, if not avoided, will result in death or serious injury. This is limited to the most extreme situations.

Warning: Indicates a potentially hazardous situation which, if not avoided, could result in death or serious injury.

Caution: Indicates a potentially hazardous situation which, if not avoided, could result in minor or moderate injury. It may also alert users against unsafe practices.

Notice: Indicates a statement of company policy (that is, a safety policy or protection of property).

The safety guidelines for the equipment in this manual do not purport to address all the safety issues of the equipment. It is the responsibility of the user to establish appropriate safety, ergonomic, and health practices and determine the applicability of regulatory limitations prior to use. Potential safety hazards are identified in this manual through the use of words *Danger*, *Warning*, and *Caution*, the specific hazard type, and pictorial alert icons.

Revision History

Revision	Date Released	Description of Changes
A	5/14/2009	This is the first release of the manual.

Contents

Chapter 1 Product Overview	1
1.1 How to Identify This Product	1
1.2 Typical System Installation	2
1.3 Product Features	3
1.4 Supported Protocols	3
1.5 Supported SIP Servers	3
1.6 Product Specifications	4
1.7 Dimensions	4
Chapter 2 Installing the VoIP Emergency Intercom	5
2.1 Parts List	5
2.1 Intercom Setup	6
2.1.1 VoIP Intercom Connections	6
2.1.2 Connecting a Device to the Auxiliary Relay	7
2.1.3 Identifying the VoIP Intercom Connectors	8
2.1.4 Call Button and Indicator Light	9
2.1.5 Network Connectivity, and Data Rate	10
2.1.6 RTFM Switch Jumper	11
2.1.7 Adjust the Volume	12
2.1 Configure the Intercom Parameters	13
2.1.1 Log in to the Configuration Home Page	14
2.1.2 Configure the Network Parameters	16
2.1.3 Set up the Intercom	18
2.1.4 Configure the SIP Parameters	21
2.1.5 Configure the Sensor Setup Parameters	25
2.1 Upgrade the Firmware and Reboot the Intercom	27
2.1.1 Reboot the Intercom	30
Appendix A Mounting the Indoor Intercom	31
A.1 Mount the Intercom	31
Appendix B Setting up a TFTP Server	34
B.1 Set up a TFTP Server	34
B.1.1 In a LINUX Environment	34
B.1.2 In a Windows Environment	34
B.1.3 In a Solarwinds Server Environment	34
Appendix C Troubleshooting/Technical Support	35
C.1 Frequently Asked Questions (FAQ)	35
C.2 Documentation	35
C.3 Contact Information	35
C.4 Warranty	36
Index	37

1 Product Overview

1.1 How to Identify This Product

To identify the VoIP Emergency Intercom, look for a model number label similar to the one shown in [Figure 1-1](#). The number on the label should be 011035.

Figure 1-1. Model Number Label

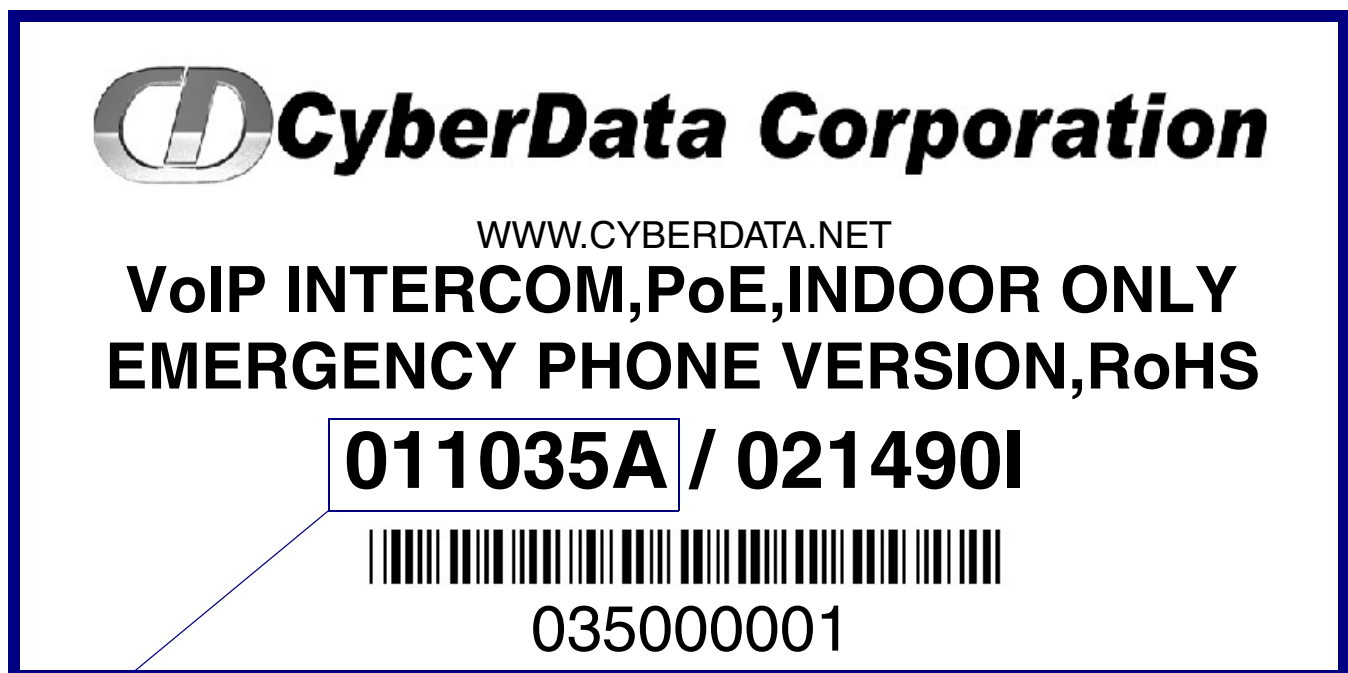

Model number



1.2 Typical System Installation

The Voice-over-IP (VoIP) VoIP Emergency Intercom is a SIP endpoint designed to provide VoIP phone connectivity in a tamper proof and secure package.

Figure 1-2 illustrates how the VoIP Emergency Intercom can be installed as part of a VoIP phone system.

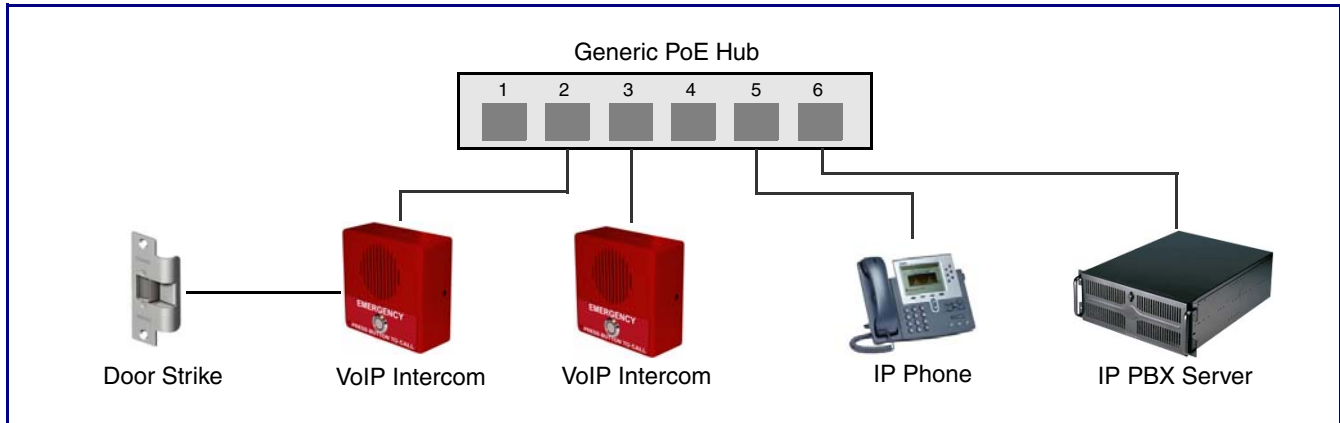
Figure 1-2. Typical Installation—Door Entry/Access Control



 GENERAL ALERT	<p>Warning <i>Electrical Hazard:</i> The VoIP Intercom enclosure is not rated for any AC voltages.</p>
 GENERAL ALERT	<p>Warning <i>Electrical Hazard:</i> This product should be installed by a licensed electrician according to all local electrical and building codes.</p>
 GENERAL ALERT	<p>Warning <i>Electrical Hazard:</i> To prevent injury, this apparatus must be securely attached to the floor/wall in accordance with the installation instructions.</p>

1.3 Product Features



- *PoE 802.3af enabled (Powered-over-Ethernet)*
- *SIP compliant*
- *Adaptive half-duplex voice operation*
- *Network web management*
- *Network adjustable speaker volume and microphone sensitivity*
- *Network downloadable firmware*
- *Doubles as a paging speaker*
- *Dry relay contact for auxiliary control*
- *Peer-to-peer capable*
- *Door closure and tamper alert signal*
- *PTT multicast support*

1.4 Supported Protocols

The Intercom supports:

- SIP
- HTTP Web-based configuration

Provides an intuitive user interface for easy system configuration and verification of Intercom operations.

- DHCP Client

Dynamically assigns IP addresses in addition to the option to use static addressing.

- TFTP Client

Facilitates Web-based firmware upgrades of the latest Intercom capabilities.

- RTP
- RTP/AVP - Audio Video Profile
- Audio Encodings

PCMU (G.711 mu-law)

PCMA (G.711 A-law)

Packet Time 20 ms

1.5 Supported SIP Servers

Information on how to configure the Intercom for the supported SIP servers is available on the VoIP Emergency Intercom product page at:

<http://www.cyberdata.net/support/voip/index.html>

1.6 Product Specifications

Category	Specification
Speaker Output	1 Watt Peak Power
Network Rate	10/100 Mbps
Power Requirement	PoE 802.3af compliant or +5 volts at 1000mA
Protocol	SIP
Part Number	011035
Dimensions	4.53" x 4.53" x 2.11" (H x W x D)
Weight	0.71 lbs./shipping weight of 1.1 lbs. (0.32 kg/shipping weight of 0.5 kg)
Auxiliary Relay	2 A at 30 VDC

1.7 Dimensions

Figure 1-3. Dimensions

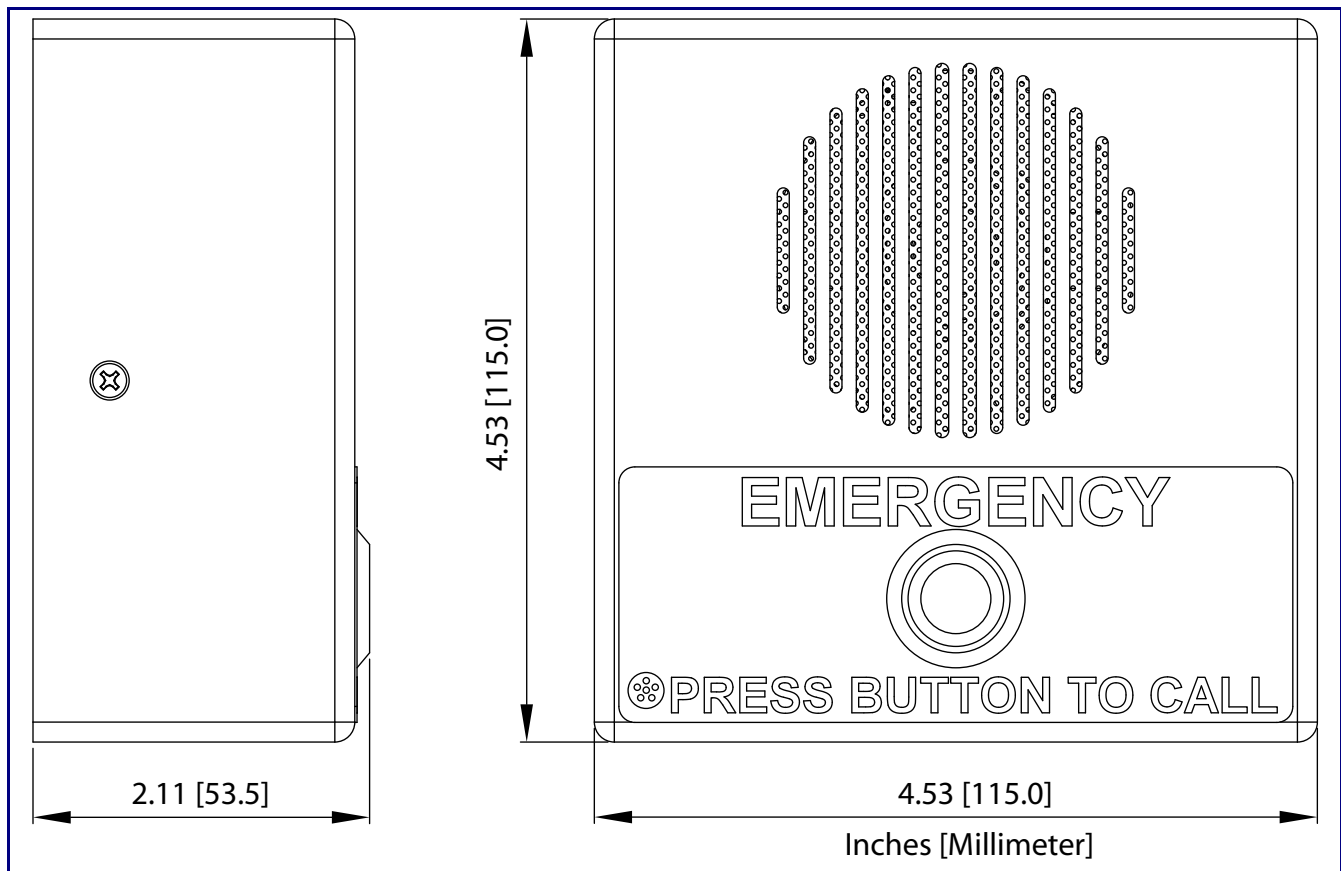



2 Installing the VoIP Emergency Intercom

2.1 Parts List

Table 2-1 illustrates the SiP VoIP and PoE Speaker parts.

Table 2-1. Parts List

Quantity	Part Name	Illustration
1	Intercom Assembly	
1	Installation Quick Reference Guide	
1	Intercom Mounting Accessory Kit	

2.1 Intercom Setup

2.1.1 VoIP Intercom Connections

Figure 2-4 shows the pin connections on the J7 (terminal block). This terminal block can accept a wire range from 16 AWG to 26 AWG.

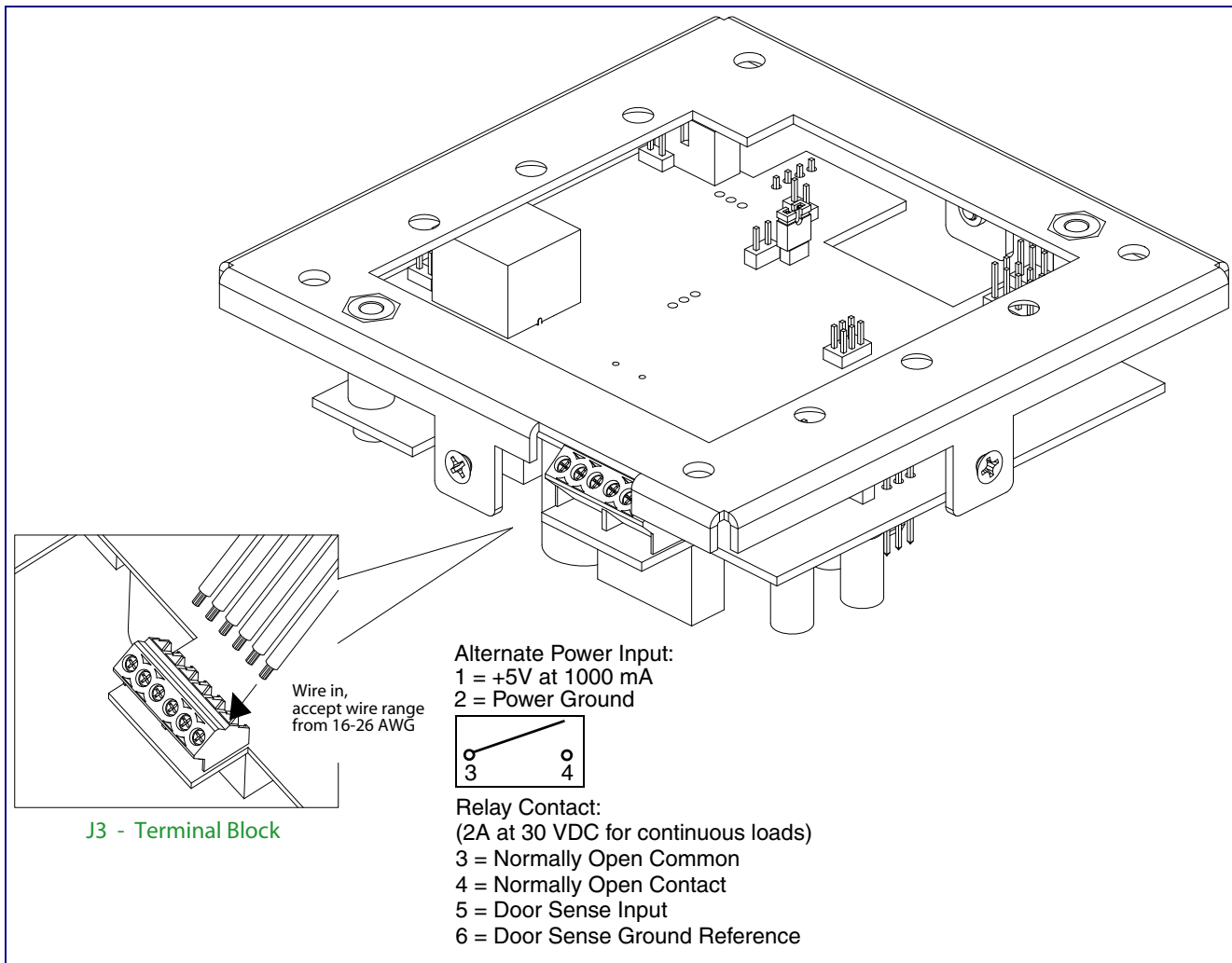

Note As an alternative to using PoE power, you can supply 5 VDC at 1000 mA into the terminal block.

Figure 2-4. VoIP Intercom Connections



2.1.2 Connecting a Device to the Auxiliary Relay

The VoIP Intercom incorporates an on-board relay which enables users to control an external relay for activating an auxiliary device such as an electric door strike (see [Figure 2-4](#)). The Intercom relay contacts are limited to 1 amp at 30VDC. The Intercom relay activation time is selectable through the web interface and is controlled by DTMF tones generated from the phone being called. The DTMF tones are selectable from the web interface as well.

 <p>GENERAL ALERT</p>	<p>Warning <i>Electrical Hazard:</i> The VoIP Intercom enclosure is not rated for any AC voltages.</p>
 <p>GENERAL ALERT</p>	<p>Warning <i>Electrical Hazard:</i> This product should be installed by a licensed electrician according to all local electrical and building codes.</p>
 <p>GENERAL ALERT</p>	<p>Warning <i>Electrical Hazard:</i> To prevent injury, this apparatus must be securely attached to the floor/wall in accordance with the installation instructions.</p>

Note The three digit code for the auxiliary relay must be sent in conformance with RFC2833 DTMF generation.

Figure 2-5. Auxiliary Relay Wiring Diagram

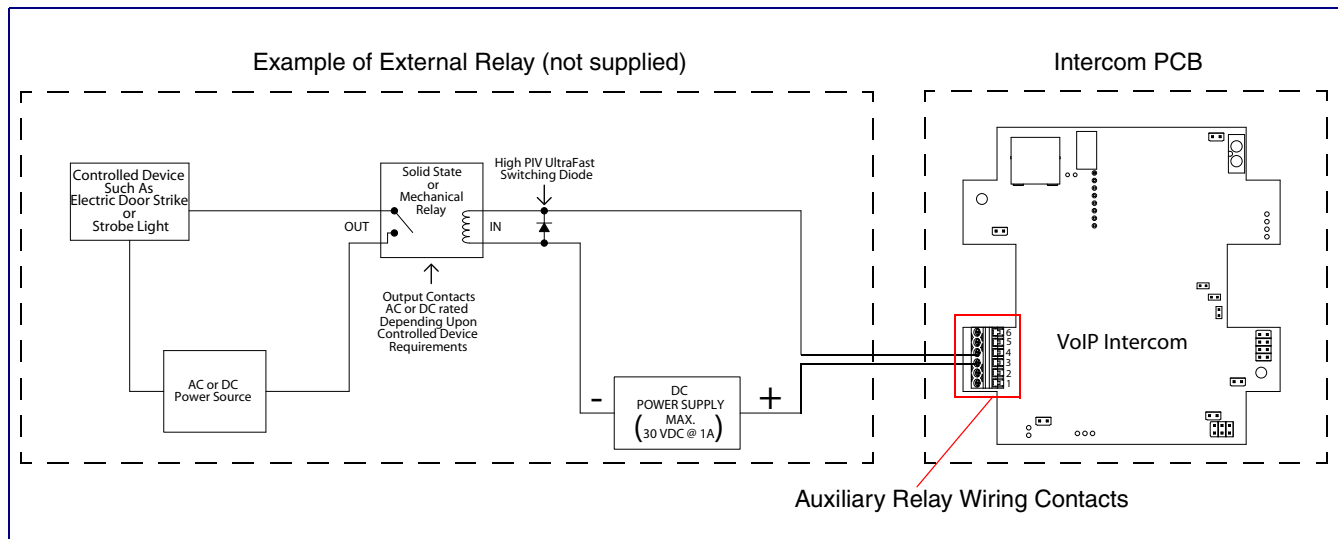

2.1.3 Identifying the VoIP Intercom Connectors

See [Figure 2-6](#) and [Table 2-2](#) to identify the connector locations and functions.

Figure 2-6. Connector Locations

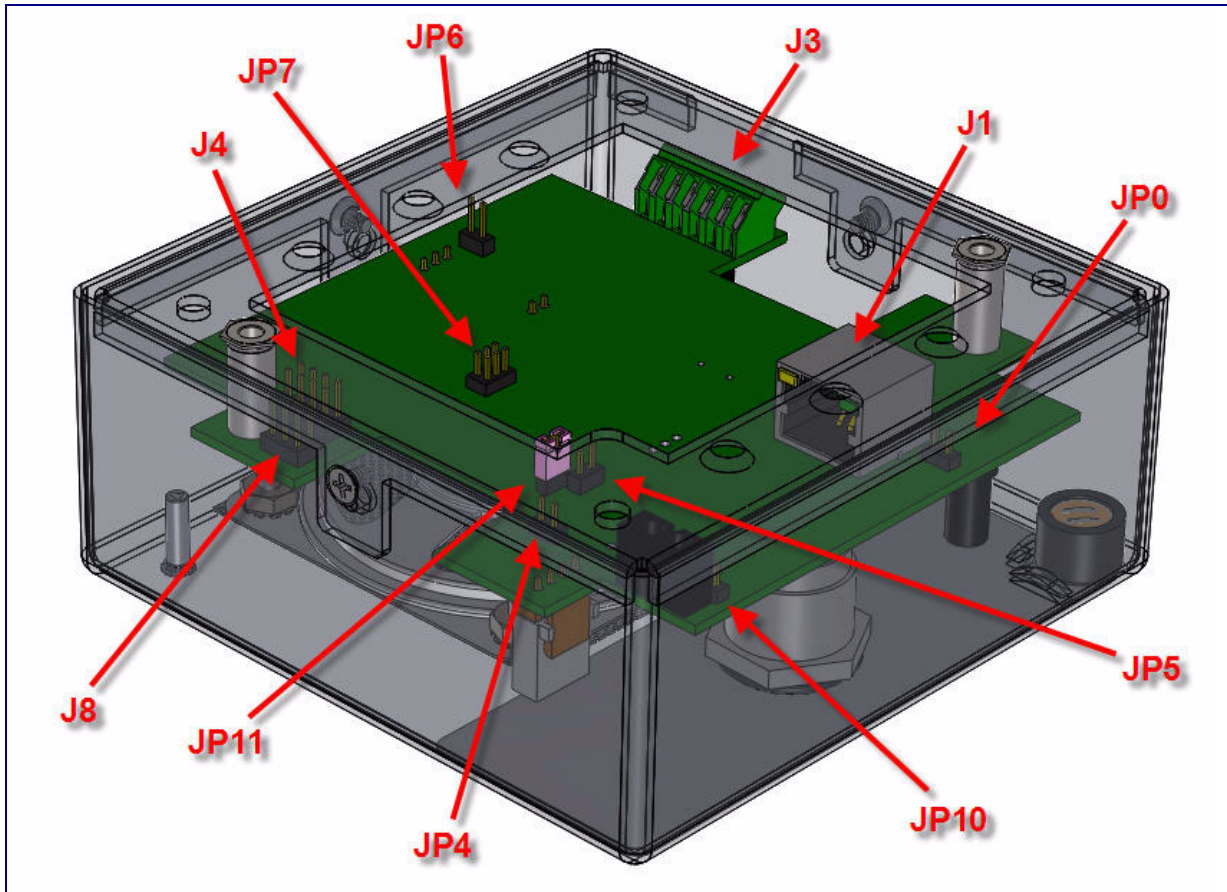

Table 2-2. Connector Functions

Jumper	Setting
J1	PoE Network Connection (RJ-45 ethernet)
J4	J-Tag (Factory only)
J3	Terminal Block (see Figure 2-4)
JP2	Call-Button/LED interface
JP4	Reset (Factory only)
JP5	Microphone Interface
JP6	Speaker Interface
JP8	Console (Factory only)
JP11	RTFM (see Section 2.1.6, "RTFM Switch Jumper")

2.1.4 Call Button and Indicator Light

2.1.4.1 Initial Power

Upon initial power or reset, you will see the following:

- The light is on.
- The light will blink twice to indicate that the Intercom has acquired its network settings and is operational.
- The first blink indicates that the Intercom has acquired its network settings.
- The second blink indicates that the Intercom is operational.

2.1.4.2 Calling

- You may initiate a call by pressing the **Call** button.
- An active call is indicated by the light blinking at one second intervals.
- The Intercom will automatically answer an incoming call.
- You can press the **Call** button to terminate an active call whether the call was an incoming call or a call that was initiated by you.

Figure 2-7. Call Button and Indicator Light

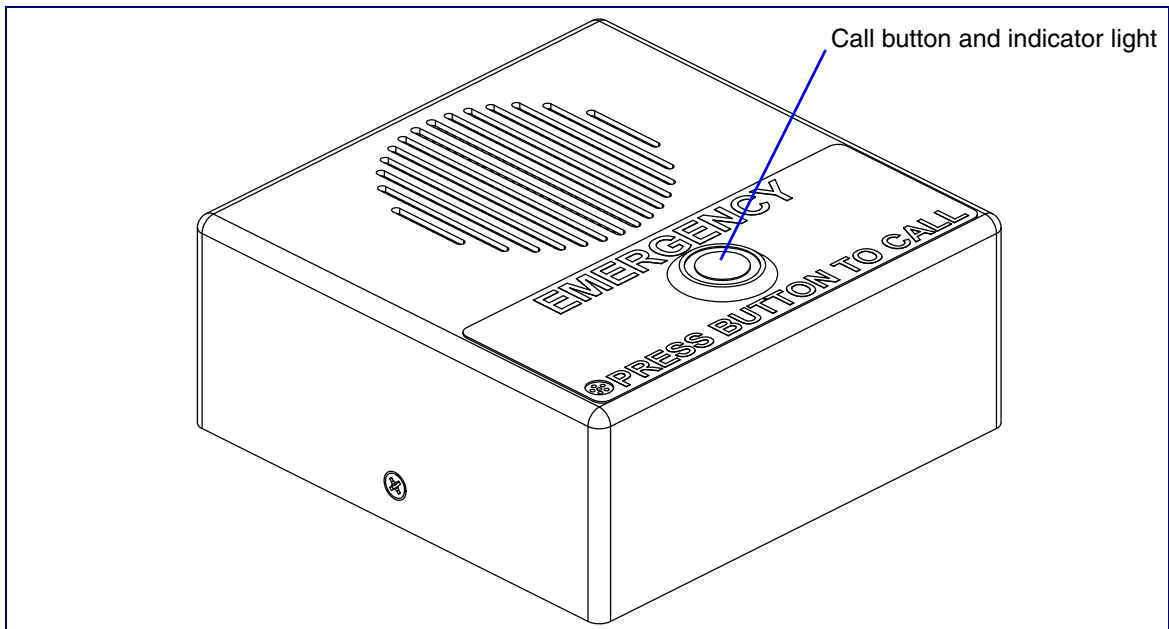

2.1.5 Network Connectivity, and Data Rate

When you plug in the Ethernet cable or power supply:

- The square, green **Link** light above the Ethernet port indicates that the network connection has been established (see [Figure 2-8](#)). The Link light changes color to confirm the auto-negotiated baud rate:
 - This light is yellow at 10 Mbps.
 - It is orange at 100 Mbps.

2.1.5.1 Verify Network Activity

The square, yellow **Activity** light blinks when there is network activity.

Figure 2-8. Network Connector

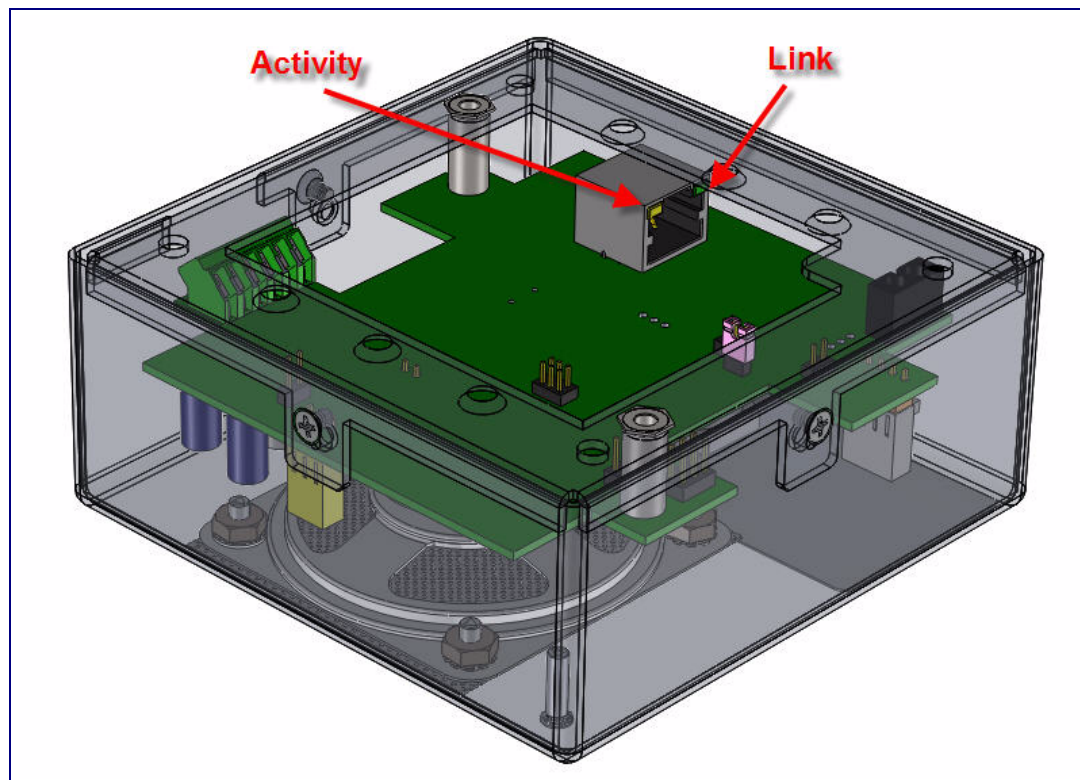

2.1.6 RTFM Switch Jumper

When the Intercom is operational and linked to the network, use the Reset Test Function Management (**RTFM**) switch (see [Figure 2-9](#)) on the Intercom board to announce and confirm the Intercom's IP Address, test that the audio is working, and check the volume.

Note You must do this test prior to final assembly. Please remember to remove the RTFM switch jumper prior to final assembly.

Figure 2-9. RTFM Switch Jumper

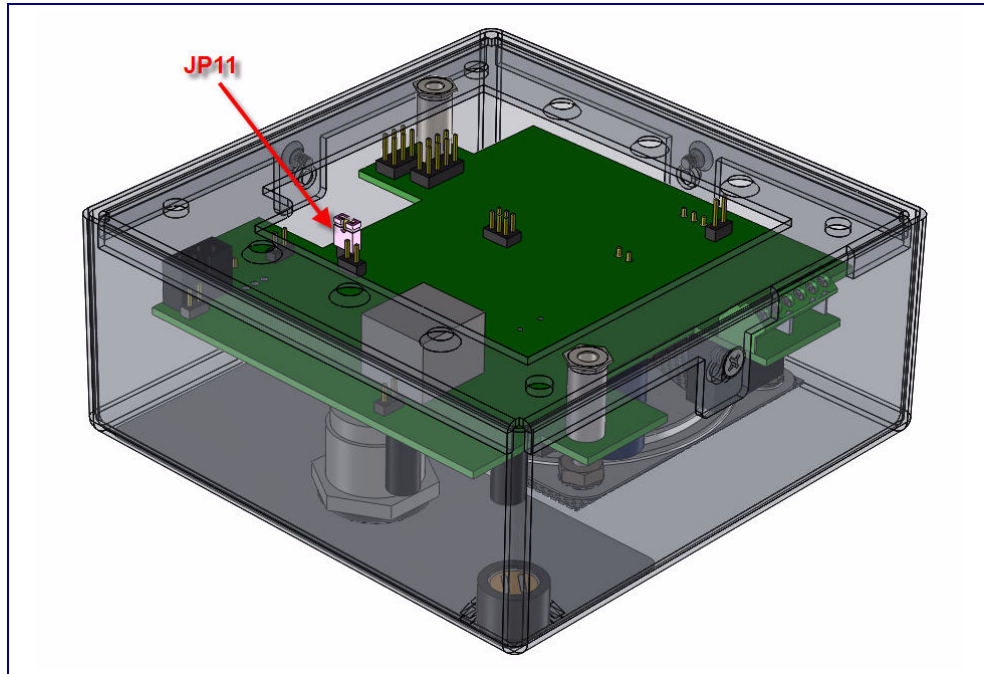

2.1.6.1 Announcing the IP Address

To announce an Intercom's current IP address:

1. Unplug the Intercom.
2. Install the RTFM jumper on JP11.
3. Plug the network cable into the Intercom to supply power to the Intercom. The LED will illuminate during initialization, blink once, and then turn off.
4. The Intercom will announce the IP address.
5. After the Intercom has rebooted, remove the jumper from JP11.
6. Cycle power by disconnecting the PoE cable from J1 and plugging the PoE cable back into J1.

2.1.6.2 Restore the Factory Default Settings

When troubleshooting configuration problems, it is sometimes convenient to restore the device to a known state.

Each Intercom is delivered with factory set default values. Use the **RTFM** switch on the Intercom face to restore these parameters to the factory default settings.

To restore the factory default settings:

1. Complete steps 1 through 4 in [Section 2.1.6.1, "Announcing the IP Address"](#).
2. Press and hold the **Call** button for **10** seconds.
3. When you hear the announcement, release the **Call** button. The factory default settings are restored, and the Intercom will automatically restart.
4. After the Intercom has rebooted, remove the jumper from JP11.
5. Cycle power by disconnecting the PoE cable from J1 and plugging the PoE cable back into J1.

Figure 2-10. RTFM Switch Jumper

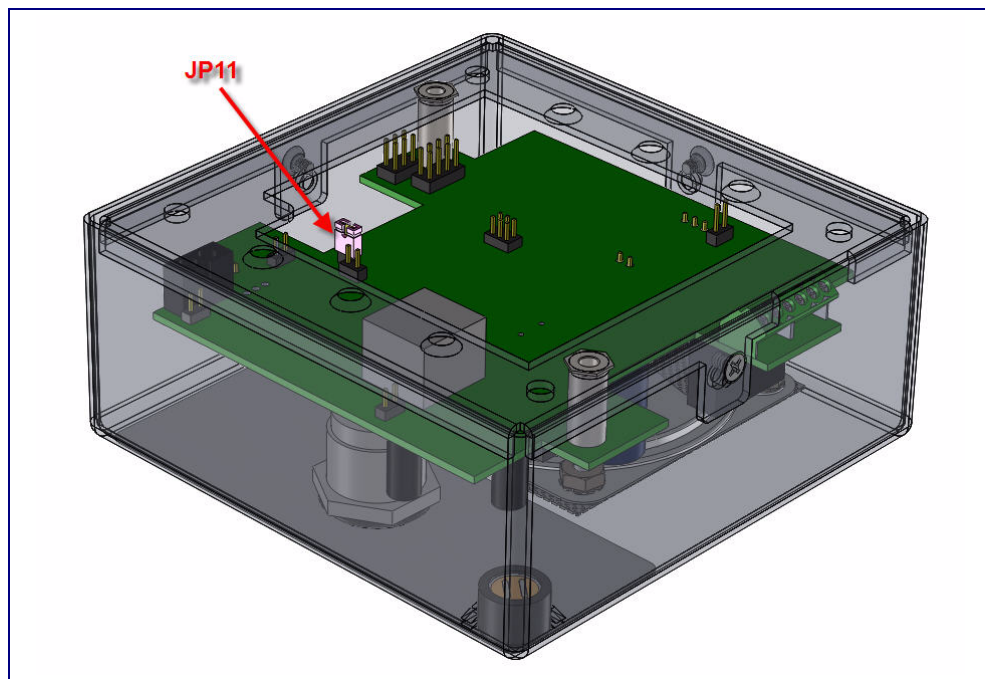

2.1.7 Adjust the Volume

You will be only able to adjust the volume through the network configuration page.

2.1 Configure the Intercom Parameters

To configure the Intercom online, use a standard web browser.

Configure each Intercom and verify its operation *before* you mount it. When you are ready to mount an Intercom, refer to [Appendix A, "Mounting the Indoor Intercom"](#) for instructions.

All Intercoms are initially configured with the following default IP settings:

When configuring more than one Intercom, attach the Intercoms to the network and configure one at a time to avoid IP address conflicts.

Table 2-3. Factory Default Settings

Parameter	Factory Default Setting
IP Addressing	static
IP Address	192.168.3.10
Web Access Username	admin
Web Access Password	admin
Subnet Mask	255.255.255.0
Default Gateway	192.168.3.1

2.1.1 Log in to the Configuration Home Page

1. Open your browser to the Intercom IP address.

For the initial configuration of the Intercom, open your browser to the default IP address:

<http://192.168.3.10>

Note Make sure that the PC is on the same IP network as the Intercom.

Note You may also download CyberData's VoIP Discovery Utility program which allows you to easily find and configure the default web address of the CyberData VoIP products. CyberData's VoIP Discovery Utility program is available on the VoIP Emergency Intercom product page at:

<http://www.cyberdata.net/support/voip/index.html>

2. When prompted, use the following default **Web Access Username** and **Web Access Password** to access the **Home Page** (Figure 2-11):

Web Access Username: **admin**

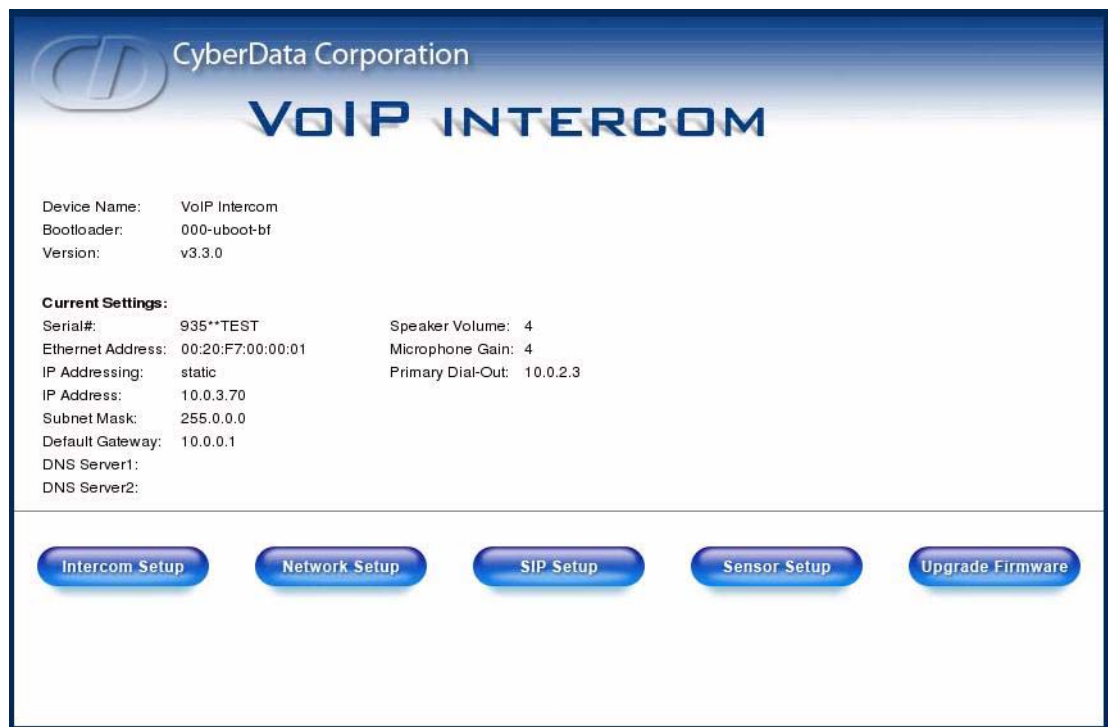

Web Access Password: **admin**

Figure 2-11. Home Page



3. On the **Home Page**, review the setup details and navigation buttons described in [Table 2-4](#).

Table 2-4. Home Page Overview

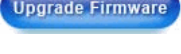
Web Page Item	Description
Device Name	Shows the device name.
Serial #	Device serial number.
Ethernet Address	Device ethernet address.
IP Addressing	Shows the current IP addressing setting (DHCP or static).
IP Address	Shows the current IP address.
Subnet Mask	Shows the current subnet mask address.
Default Gateway	Shows the current default gateway address.
DNS Server 1	Shows the current DNS server 1 address.
DNS Server 2	Shows the current DNS server 2 address.
Speaker Volume (0-9)	Shows the current volume level.
Microphone Gain (0-9)	Shows the current microphone gain level.
Primary Dial-Out	Shows the current primary dial-out number
	Link to the Intercom Setup web page.
	Link to the Network Setup web page.
	Link to the SIP Setup web page.
	Link to the Upgrade Firmware web page.

2.1.2 Configure the Network Parameters

1. Click the **Network Setup** button to open the **Network Setup** page (Figure 2-12).

Figure 2-12. Network Setup Page

2. On the **Network Setup** page, enter values for the parameters indicated in Table 2-5.

Table 2-5. Network Setup Parameters





Web Page Item	Description
IP Addressing*	Select either DHCP IP Addressing or Static IP Addressing by marking the appropriate radio button. If you select Static , configure the remaining parameters indicated in Table 2-5. If you select DHCP , go to Step 3.
IP Address*	Enter the Static IP address.
Subnet Mask	Enter the Subnet Mask address.
Default Gateway	Enter the Default Gateway address.
DNS Server 1*	Enter the DNS Server 1 address.
DNS Server 2*	Enter the DNS Server 2 address.
	Click this button to save your configuration settings. Changing a parameter that has an asterisk next to it will cause a system reboot when saved.
	Link to the Intercom Setup page.

Table 2-5. Network Setup Parameters (continued)

Web Page Item	Description
	Link to the SIP Setup page.
	Link to the Upgrade Firmware page.
	Link to the Home page.

3. After changing the parameters, click **Save Settings**. This updates the changed parameters and reboots the Intercom if appropriate.
4. Connect the Intercom to the target network.
5. From a system on the same network as the Intercom, open a browser with the new IP address of the Intercom.

2.1.3 Set up the Intercom

1. Click the **Intercom Setup** button to open the **Intercom Setup** page. See [Figure 2-13](#).

Figure 2-13. Intercom Setup

The screenshot displays the 'Intercom Setup' configuration page for a VoIP Intercom system. The page header includes the CyberData Corporation logo and the text 'VOIP INTERCOM'. The main section is titled 'Intercom Setup' and contains the following fields and options:

- Device Name:
- Change Username:
- Change Password:
- Re-enter New Password:
- Speaker Volume (0-9): *
- Microphone Gain (0-9): *
- Auto Answer: Yes No *
- Activate Relay During Ring: Yes No *
- Activate Relay On Button Press: Yes No *
- Relay on Button Press Timeout (in seconds):
- Auxiliary Relay: On Off
- DTMF Relay Activation Code (3 digit):
- Relay Activation Duration (0-9)sec:
- Button Lit when Idle: Yes No *
- Play Ringback tone: Yes No *

* changing this parameter causes system reboot when saved

At the bottom of the form, there are three buttons: **Save Settings**, **Relay Test**, and **Audio Test**. Below these, a navigation bar contains five buttons: **Home Page**, **Network Setup**, **SIP Setup**, **Sensor Setup**, and **Upgrade Firmware**.

2. On the **Intercom Setup** page, enter values for the parameters indicated in [Table 2-6](#).

Table 2-6. Intercom Setup Parameters







Web Page Item	Description
Device Name	Enter a descriptive name for this device (if desired).
Change Username	Use this field to change the Web Access Username
Change Password	Use this field to change the Web Access Password
Re-enter New Password	Use this field to re-enter a new password
Speaker Volume (0 - 9)	Shows the current volume level.
Microphone Gain (0 - 9)	Shows the current microphone gain level.
Auto Answer	When Auto Answer is Off , the Intercom will play a ringtone through the speaker until someone presses the button.
Activate Relay During Ring	With the Activate Relay During Ring option, the relay will be activated for as long as the phone is ringing. NOTE: When the phone is set to Auto Answer , it will not ring and this option does nothing.
Activate Relay On Button Press	If you select Yes , this will activate the relay for a user-selectable amount of time when the button is pressed.
Relay on Button Press Timeout (in seconds)	Type the desired number of seconds for the timeout on the relay after the button is pressed.
Auxiliary Relay	Allows you to enable or disable the auxiliary relay.
DTMF Relay Activation Code (3 digits)	Use this field to enter the DTMF relay activation code.
DTMF Activation Duration (in seconds)	Type the desired DTMF activation duration (in seconds). NOTE: A DTMF activation duration of 0 will toggle the relay indefinitely or until the activation code is sent again
Button Lit When Idle	If you select Yes , the front button light will remain on when a call is not active. If you select No , the front button light will remain off when a call is not active. The button light will still flash when a call is active.
Play Ringback tone	If you select Yes , then while initiating a call to a remote phone, this will enable the Intercom to play a ringtone while the remote device is ringing.
	Click on this button to save your configuration settings.
	Click on this button to do a relay test. Generates a voice message for testing the Intercom audio quality and volume.
	Click on this button to do an audio test. Generates a voice message for testing the Intercom audio quality and volume.
	Link to the Home page.

Table 2-6. Intercom Setup Parameters (continued)

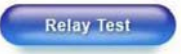
Web Page Item	Description
	Link to the Network Setup page.
	Link to the SIP Setup page.
	Link to the Sensor Setup page.
	Link to the Upgrade Firmware page.

3. After changing the parameters, click **Save Settings**.

2.1.4 Configure the SIP Parameters

1. Click **SIP Setup** to open the **SIP Setup** page (Figure 2-14).

Note For specific server configurations, go to the VoIP Emergency Intercom product page at: <http://www.cyberdata.net/support/voip/index.html>

Figure 2-14. SIP Setup Page





The screenshot shows the 'SIP Setup' page for CyberData Corporation's VoIP Intercom. The page has a blue header with the company logo and name. Below the header, the title 'SIP Setup' is displayed. The main content area contains several configuration fields, each with a text input box and an asterisk indicating a required field. The fields and their values are: SIP Server (10.0.1.4), Outbound Proxy (empty), Remote SIP Port (5060), Local SIP Port (5060), SIP User ID (199), Authenticate ID (199), Authenticate Password (ext199), SIP Registration (radio buttons for Yes and No, with No selected), Register Expiration (minutes) (60), and Dial-Out Extension (10.0.2.3). Below the fields, a note states '* changing this parameter causes system reboot when saved'. A blue 'Save Settings' button is located below the note. At the bottom of the page, there are five blue navigation buttons: Home Page, Intercom Setup, Network Setup, Sensor Setup, and Upgrade Firmware.

2. On the **SIP Setup** page, enter values for the parameters indicated in Table 2-7.

Table 2-7. SIP Setup Parameters

Web Page Item	Description
SIP Server*	Enter the SIP server represented as either a numeric IP address in dotted decimal notation or the fully qualified host name (FQHN) up to 64 characters.
Outbound Proxy	Enter the Outbound Proxy as either a numeric IP address in dotted decimal notation or the fully qualified host name (FQHN) up to 64 characters.
Remote SIP Port*	Enter the Remote SIP Port number (default 5060).
Local SIP Port*	Enter the Local SIP Port number (default 5060).
SIP User ID*	Enter the SIP User ID (up to 25 alphanumeric characters).

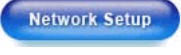
Table 2-7. SIP Setup Parameters (continued)

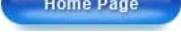
Web Page Item	Description
Authenticate ID*	Enter the Authenticate ID (up to 25 alphanumeric characters).
Authenticate Password*	Enter the Authenticate Password (up to 25 alphanumeric characters).
SIP Registration*	Enable/Disable SIP Registration.
Unregister on Reboot*	<ul style="list-style-type: none"> • Select Yes to automatically unregister the Intercom when it is rebooted. • Select No to keep the Intercom registered when it is rebooted.
Register Expiration*	Enter the SIP Registration lease time in minutes (default 60 minutes).
Dial-Out Extension	<p>Enter the button dial-out extension number.</p> <p>The Dial Out Extension also supports the addition of comma delimited pauses before sending additional DTMF tones (using rfc2833). The first comma will pause three seconds after a call is first established with a remote device. Subsequent commas will pause for two seconds. A pause of one second will be sent after each numerical digit.</p> <p>Examples of Dial-Out Extension strings:</p> <p>302: Dial out extension 302 and establish a call.</p> <p>302,2: Dial out extension 302 and establish a call. Wait three seconds and then send the DTMF tone '2'.</p> <p>302,25,,4,,1: Dial out extension 302 and establish a call. Wait 3 seconds and then send the DTMF tone '2'. Send out DTMF tone 5. Wait six seconds. Send out DTMF tone 4. Wait four seconds. Send out DTMF tone 1.</p> <p>Note: The maximum number of total characters in the dial-out field is 25.</p>
	Click this button to save your configuration settings. Changing a parameter that has an asterisk next to it will cause a system reboot when saved.
	Link to the Intercom Setup page.
	Link to the Network Setup page.
	Link to the Upgrade Firmware page.
	Link to the Home page.

3. After changing the parameters, click **Save Settings**.

2.1.4.1 Point-to-Point Configuration

When the board is set to not register with a SIP server (see [Figure 2-15](#)), it's possible to set the intercom to dial out to a single endpoint.

In this case, the dial-out extension should be the IP address of the remote device. The Intercom can also receive Point-to-Point calls. The delayed DTMF functionality is available in the Point-to-Point Mode.

Note Receiving point-to-point SIP calls may not work with all phones.

Figure 2-15. SIP Setup Page Set to Point-to-Point Mode

The screenshot shows the 'SIP Setup' configuration page for a CyberData Corporation VoIP Intercom. The page has a blue header with the company logo and name. Below the header, the title 'SIP Setup' is displayed. The configuration fields are as follows:

SIP Server:	10.0.1.4
Outbound Proxy:	
Remote SIP Port:	5060
Local SIP Port:	5060
SIP User ID:	199
Authenticate ID:	199
Authenticate Password:	ext199
SIP Registration:	<input type="radio"/> Yes <input checked="" type="radio"/> No
Register Expiration (minutes):	60
Dial-Out Extension:	10.0.2.3

Below the fields, there is a note: ** changing this parameter causes system reboot when saved*. A blue button labeled 'Save Settings' is positioned below the note. At the bottom of the page, there are five navigation buttons: 'Home Page', 'Intercom Setup', 'Network Setup', 'Sensor Setup', and 'Upgrade Firmware'. A blue arrow points from the 'No' radio button in the 'SIP Registration' field to the text 'Board is set to not register with a SiP server' located below the screenshot.

Board is set to not register with a SiP server

2.1.4.2 Delayed DTMF

On the SIP setup page the dial out extension now supports the addition of comma delimited pauses and sending additional DTMF tones (using rfc2833). The first comma will pause three seconds after a call is first established with a remote device. Subsequent commas will pause for 2 seconds. A pause of one second will be sent after each numerical digit.

Table 2-8. Examples of Dial-Out Extension Strings

Extension String	Resulting Action
302	Dial out extension 302 and establish a call
302,2	Dial out extension 302 and establish a call, wait 3 seconds then send the DTMF tone '2'
302,25,,,4,,1	Dial out extension 302 and establish a call, wait 3 seconds then send the DTMF tone '2', send out DTMF tone 5, wait 6 seconds, send out DTMF tone 4, wait 4 seconds, send out DTMF tone 1

Note The maximum number of total characters in the dial-out field is 25.

2.1.5 Configure the Sensor Setup Parameters

The door sensor (pins 5 and 6) on the header can be used to monitor a door's open or closed state. There is an option on the sensor setup page to trigger on an open or short condition on these pins. The door sensor alarm will be activated when the **Door Open Timeout** parameter has been met.

The intrusion sensor is an optical sensor installed on the Intercom board and will be activated when the Intercom is removed from the case.

For each sensor there are four actions the Intercom can take:

- Flash the LED until the sensor is deactivated (roughly 10 times/second)
- Activate the relay until the sensor is deactivated
- Loop an audio file out of the Intercom speaker until the sensor is deactivated
- Call a preset extension and play a pre-recorded audio file (once)

Note Calling a preset extension can be setup as a point-to-point call, but currently can't send delayed DTMF tones.

1. Click **Sensor Setup** to open the **Sensor Setup** page (Figure 2-16).

Figure 2-16. Sensor Setup Page

CyberData Corporation
VOIP INTERCOM

Sensor Setup

Door Sensor:

Flash Button LED: Yes No

Activate Relay: Yes No

Play Audio Locally: Yes No

Play Audio Remotely: Yes No

Door Open Timeout (in seconds):

Door Sensor Normally Closed: Yes No

Dial Out Extension:

Intrusion Sensor:

Flash Button LED: Yes No

Activate Relay: Yes No

Play Audio Locally: Yes No

Play Audio Remotely: Yes No

Dial Out Extension:





Save Settings **Door Test** **Intrusion Test** **Reboot**

Changes won't take effect until the device is rebooted

Home Page **Intercom Setup** **Network Setup** **SIP Setup** **Upgrade Firmware**

2. On the **Sensor Setup** page, enter values for the parameters indicated in [Table 2-9](#).

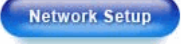
Table 2-9. Sensor Setup Parameters

Web Page Item	Description
Door Sensor	
Flash Button LED*	Select Yes to flash the LED until the sensor is deactivated (roughly 10 times/second).
Activate Relay	Select Yes to activate the relay until the sensor is deactivated.
Play Audio Locally	Select Yes to loop an audio file out of the Intercom speaker until the sensor is deactivated.
Play Audio Remotely	Select Yes to call a preset extension and play a pre-recorded audio file (once).
Dial Out Extension	Enter the button dial-out extension number.
Door Open Timeout (in seconds)	Select the number of seconds that you want to pass before the door sensor is activated.
Door Sensor Normally Closed	Select the inactive state of the door sensors.
Intrusion Sensor	
Flash Button LED*	Select Yes to flash the LED until the sensor is deactivated (roughly 10 times/second).
Activate Relay	Select Yes to activate the relay until the sensor is deactivated.
Play Audio Locally	Select Yes to loop an audio file out of the Intercom speaker until the sensor is deactivated.
Play Audio Remotely	Select Yes to call a preset extension and play a pre-recorded audio file (once).
Dial Out Extension	Enter the button dial-out extension number.
	Click this button to save your configuration settings. Changing a parameter that has an asterisk next to it will cause a system reboot when saved.
	Link to the Intercom Setup page.
	Link to the Network Setup page.
	Link to the Upgrade Firmware page.
	Link to the Home page.

3. After changing the parameters, click **Save Settings**.

2.1 Upgrade the Firmware and Reboot the Intercom

To upload the Intercom firmware from your PC:

1. Set up a TFTP server.
If you do not already have a TFTP server running on your network, see [Appendix B, "Setting up a TFTP Server"](#).
2. Retrieve the latest Intercom firmware from the VoIP Emergency Intercom product page at: <http://www.cyberdata.net/support/voip/index.html>
3. Unzip the Intercom version file. This file may contain the following:
 - Firmware file
 - Release notes
4. Copy the firmware files to be upgraded to the appropriate TFTP server directory:
 - c:\tftp-root\for Windows
 - /tftpboot/for Linux
5. Log in to the Intercom home page as instructed in [Section 2.1.1, "Log in to the Configuration Home Page"](#).
6. Click the **Upgrade Firmware** button to open the **Firmware Upgrade** page. See [Figure 2-17](#).

Figure 2-17. Firmware Upgrade Page

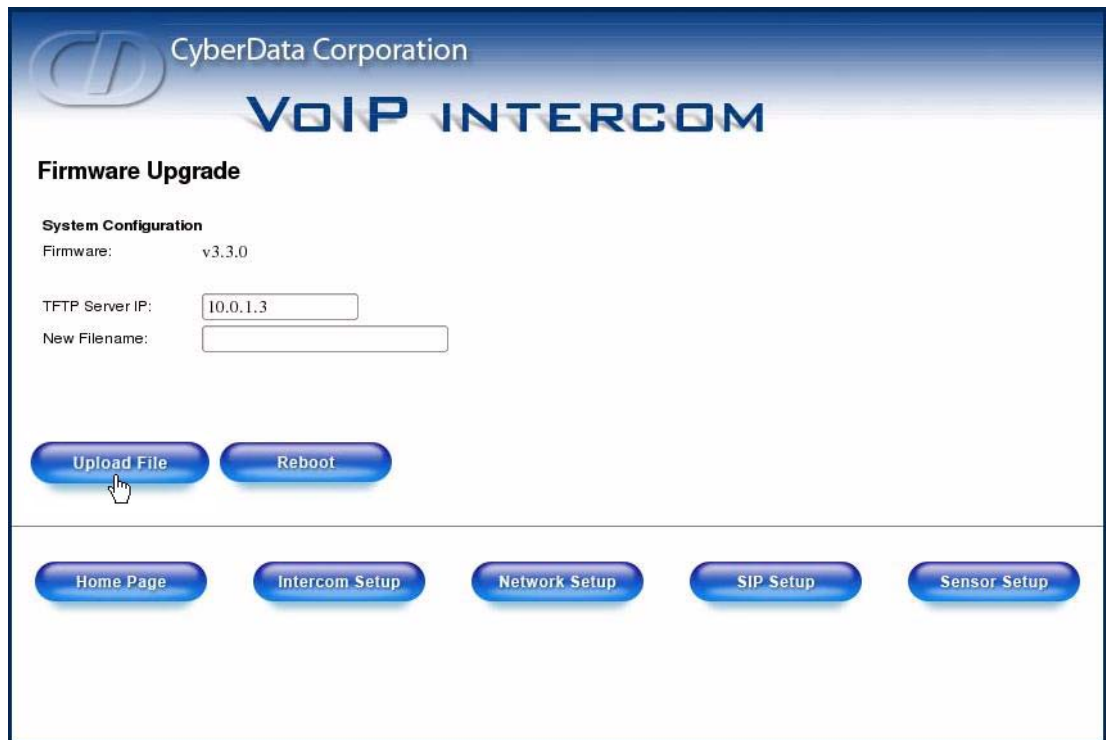

CyberData Corporation
VOIP INTERCOM

Firmware Upgrade

System Configuration
Firmware: v3.3.0

TFTP Server IP:
New Filename:

7. Enter the IP address of your TFTP server into the **TFTP Server IP** parameter field.

8. Enter the firmware filename of the file to be uploaded into the **New Filename** parameter field.
For example, kernel filename **201-image-spk-sip.bin**.

9. Click **Upload File**.

Note This starts the upload process. Once the Intercom has uploaded the file, the **Uploading Firmware** countdown page appears, indicating that the firmware is being written to flash. The Intercom will automatically reboot when the upload is complete. When the countdown finishes, the **Firmware Upgrade** page will refresh. The uploaded firmware filename should be displayed in the system configuration (indicating successful upload and reboot).

Note If you are upgrading an older version of the Intercom firmware to version 3.3.0 or later, several features will be in an unknown or random state. Therefore, in the case of a firmware upgrade to version 3.3.0 or later, CyberData recommends that you go to the **Intercom Setup** page and make sure the following values are set properly.

- Auto Answer
- Activate Relay on Ring
- Activate Relay on Button Press
- Relay on Button Press Timeout
- Button Lit when Idle
- Play Ringback Tone

On the **Sensor Setup** page make sure that all of the settings are set properly.

10. Repeat steps 8 and 9 if you are uploading the **Kernel** and **Application** files.

For example, **Application** filename **201-romdisk-spk-sip.img**.

[Table 2-10](#) shows the web page items on the **Firmware Upgrade** page.

Table 2-10. Firmware Upgrade Parameters







Web Page Item	Description
System Configuration	Shows the current configuration.
BootLoader	Shows the current boot loader filename.
Firmware	Shows the firmware for partition 1 and 2.
TFTP Server IP	Enter the TFTP Server IP address.
New Filename	Use this field to enter the new file name for the kernel or application firmware file that you are uploading.
	Click on this button to automatically upload the selected firmware and reboot the system.
	Link to the Network Setup page.
	Link to the Intercom Setup page.
	Link to go to the SIP Setup page.

Table 2-10. Firmware Upgrade Parameters (continued)

Web Page Item	Description
	Link to the Home page.
	Click on this button to reboot the system.

2.1.1 Reboot the Intercom

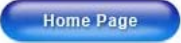
To reboot a Intercom, log in to the web page as instructed in [Section 2.1.1, "Log in to the Configuration Home Page"](#).

1. Click **Upgrade Firmware** to open the **Firmware Upgrade** page ([Figure 2-18](#)).

Figure 2-18. Reboot System Section



2. Click **Reboot**. A normal restart will occur.

Appendix A: Mounting the Indoor Intercom

A.1 Mount the Intercom

Before you mount the Intercom, make sure that you have received all the parts for each Intercom. Refer to [Table A-1](#).

Table A-1. Wall Mounting Components (Part of the Accessory Kit)



Quantity	Part Name	Illustration
4	6-32 x 1" Pan head phillips wood screw	
4	Plastic-ribbed anchor	

Table A-1. Gang Box Mounting Components

Quantity	Part Name	Illustration
4	6-32 x 0.5-inch flat undercut Phillips machine screw	

Figure A-1 shows how to properly connect the VoIP Intercom.

Figure A-1. Cable Connections

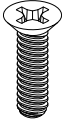
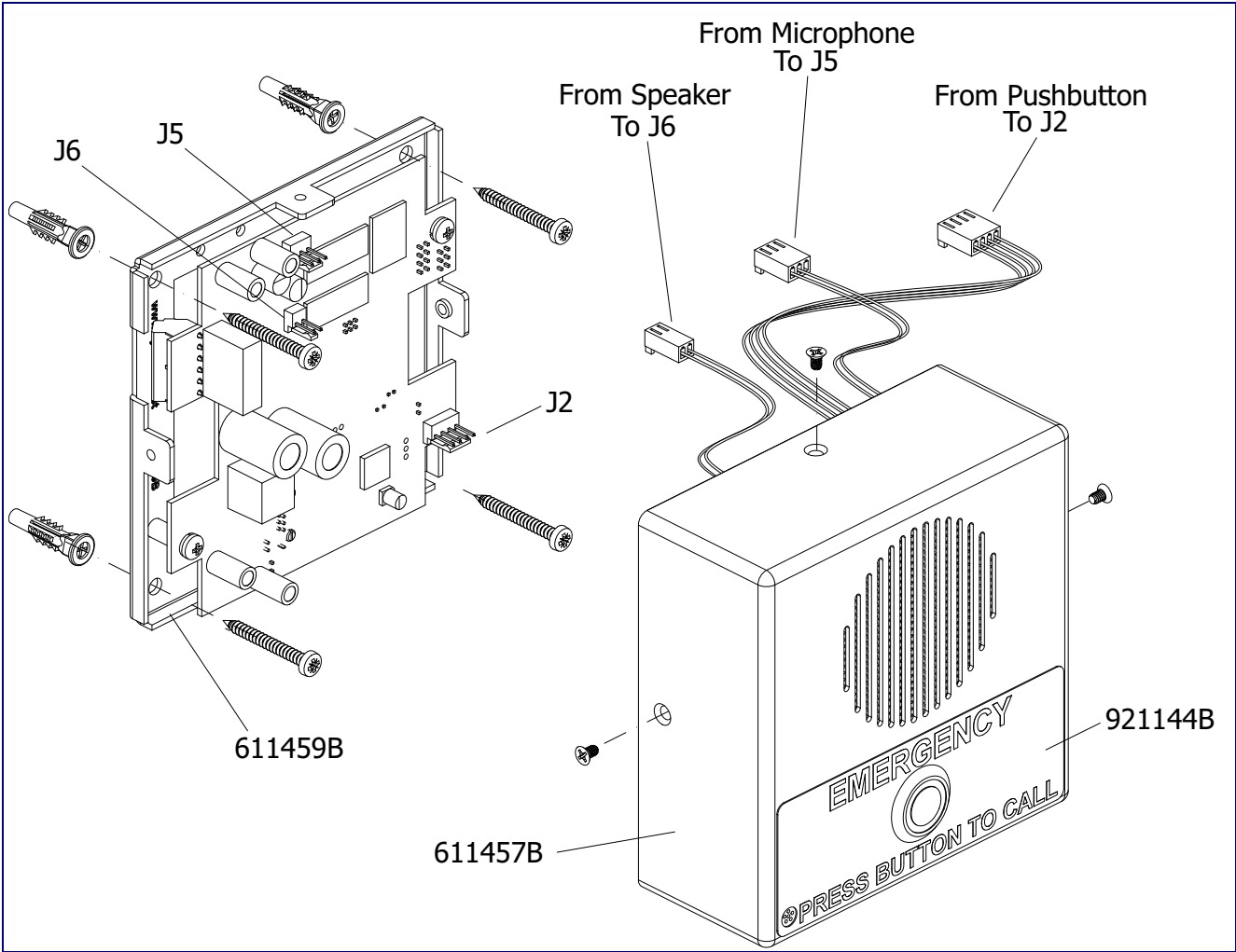
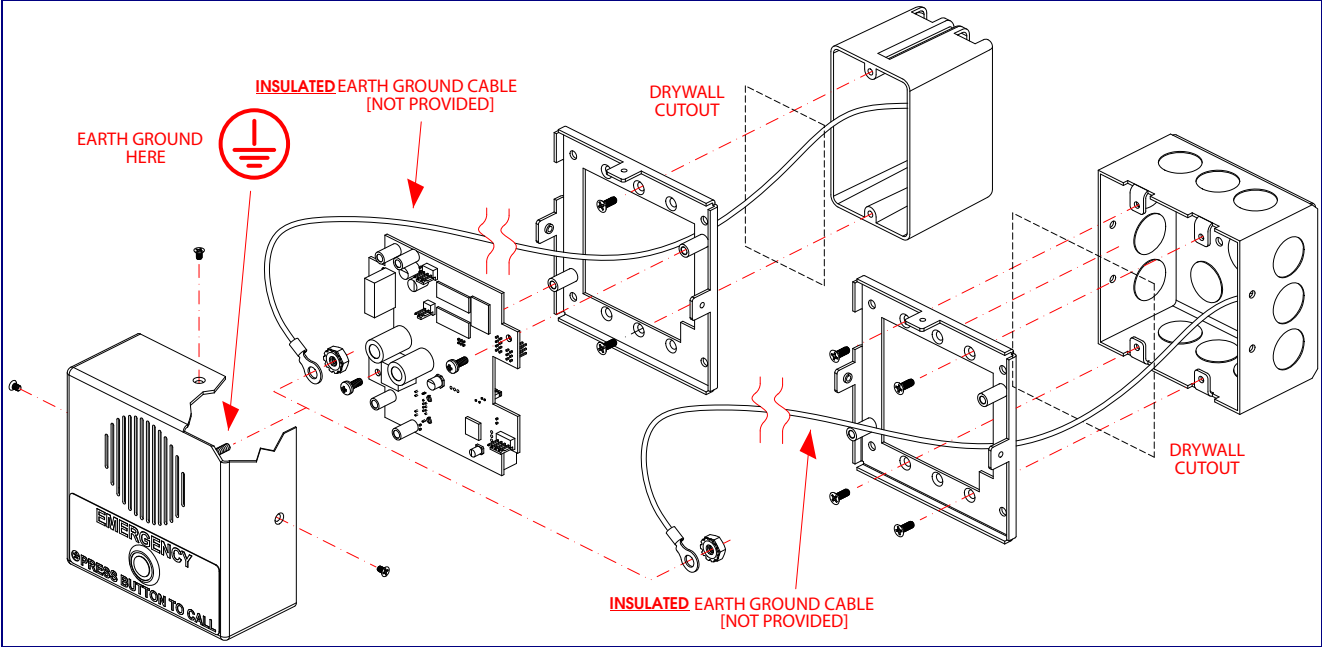

Figure A-2 shows a 1-Gang Box and a 2-Gang Box mounting option.

Note Be sure to connect the Intercom up to the Earth Ground.

Figure A-2. Gang Box Mounting



Appendix B: Setting up a TFTP Server

B.1 Set up a TFTP Server

Upgrading the VoIP Emergency Intercom firmware requires a TFTP server on which you access the Web interface where you can upload the firmware files.

B.1.1 In a LINUX Environment

To set up a TFTP server on LINUX:

1. Create a directory dedicated to the TFTP server, and move the files to be uploaded to that directory.
2. Run the following command where `/tftpboot/` is the path to the directory you created in [Step 1](#): the directory that contains the files to be uploaded. For example:

```
in.tftpd -l -s /tftpboot/your_directory_name
```

B.1.2 In a Windows Environment

You can find several options online for setting up a Windows TFTP server. This example explains how to use the Solarwinds freeware TFTP server, which you can download from the VoIP Emergency Intercom product page at:

<http://www.cyberdata.net/support/voip/index.html>

To set up a TFTP server on Windows:

1. Install and start the software.
2. Select **File/Configure/Security** tab/**Transmit Only**.
3. Make a note of the default directory name, and then move the firmware files to be uploaded to that directory.

B.1.3 In a Solarwinds Server Environment

You can find several options online for setting up a Solarwinds server. This example explains how to use the Solarwinds freeware TFTP server, which you can download from the VoIP Emergency Intercom product page at:

<http://www.cyberdata.net/support/voip/index.html>

Appendix C: Troubleshooting/Technical Support

C.1 Frequently Asked Questions (FAQ)

A list of frequently asked questions (FAQs) are available on the VoIP Emergency Intercom product page at:

<http://www.cyberdata.net/support/voip/index.html>

C.2 Documentation

The documentation for this product is released in an English language version only. You can download PDF copies of CyberData product documentation from the VoIP Emergency Intercom product page at:

<http://www.cyberdata.net/support/voip/index.html>

C.3 Contact Information

Contact	CyberData Corporation 2555 Garden Road Monterey, CA 93940 USA www.CyberData.net Phone: 800-CYBERDATA (800-292-3732) Fax: 831-373-4193
Sales	Sales 831-373-2601 Extension 334
Technical Support	Phone: 831-373-2601 Extension 333 Email: support@CyberData.net
Returned Materials Authorization	To return the product, contact the CyberData Returned Materials Authorization (RMA) department at: Phone: 831-373-2601, Extension 136 Email: RMA@CyberData.net

When returning a product to CyberData, an approved CyberData RMA number must be printed on the outside of the original shipping package. No product will be accepted for return without an approved RMA number. Send the product, in its original package, to the following address:

CyberData Corporation
2555 Garden Road
Monterey, CA 93940
Attention: RMA "your RMA number"

C.4 Warranty

CyberData warrants its product against defects in material or workmanship for a period of two years from the date of purchase. Should the product fail within the warranty period, CyberData will repair or replace the product free of charge. This warranty includes all parts and labor.

If the product is out-of-warranty and fails, a flat rate repair charge of one half the product purchase price will be assessed. Repair costs for products that are in warranty, but damaged by improper modifications or abuse, will be charged at the out-of-warranty rate. Products returned to CyberData, both in and out-of-warranty, are shipped to CyberData at the expense of the customer. Charges for shipping repaired products back to the customer will be paid by CyberData.

Index

Numerics

100 Mbps indicator light 10

A

AC voltages 2, 7
 act light 10
 activate relay (door sensor) 26
 activate relay (intrusion sensor) 26
 activate relay during ring 19
 activate relay on button press 19
 address, configuration login 14
 announcing a intercom's IP address 11, 12
 asterisk 16
 audio encodings 3
 auto answer 19
 auxiliary relay 19
 auxiliary relay wiring diagram 7

B

baud rate
 verifying 10
 button lit when idle 19

C

cable connections 32
 call button
 button lit when idle feature 19
 configurable parameters 15, 16, 19, 21, 28
 configuration
 default IP settings 13
 network 16
 SIP 21, 25
 using Web interface 13
 configuration home page 14
 connector functions 8
 connector locations 8
 CyberData contact information, corporate, sales, tech support, service 35

D

default
 gateway 13
 intercom settings 37
 IP address 13
 subnet mask 13
 username and password 13
 web login username and password 14
 default gateway 13, 16
 default intercom settings 12
 default IP settings 13
 default login address 14
 DHCP Client 3
 DHCP IP addressing 16
 dial out extension (door sensor) 26
 dial out extension (intrusion sensor) 26
 dial-out extension
 support for comma delimited pauses 22
 dial-out extension strings 24
 dimensions 4
 discovery utility program 14
 DNS server 16
 door sensor 25, 26
 activate relay 26
 dial out extension 26
 door open timeout 26
 door sensor normally closed 26
 flash button LED 26
 play audio locally 26
 play audio remotely 26
 DTMF relay activation code 19
 DTMF tones 24
 dual speeds 10

E

earth ground 33
 expiration time for SIP server lease 22

F

factory default settings 12
 firmware
 upgrading an older version of the intercom firmware to version 3.3.0 28
 where to download the latest firmware 28
 where to get the latest firmware 27

firmware upgrades 34
 flash button LED (door sensor) 26
 flash button LED (intrusion sensor) 26

G

gang box mounting 33
 green link light 10

H

home page 14
 http web-based configuration 3

I

identifying your product 1
 illustration of intercom mounting process 31
 installation, typical intercom system 2
 intercom configuration
 default IP settings 13
 intercom configuration page
 configurable parameters 15, 16, 19, 21, 28
 intercom operations, verifying 18
 intercom setup 18
 intrusion sensor 25, 26
 activate relay 26
 dial out extension 26
 flash button LED 26
 play audio locally 26
 play audio remotely 26
 IP address 13, 16, 28
 IP addressing 16
 default setting 13

L

lease, SIP server expiration time 22
 link light 10
 Linux, setting up a TFTP server on 34
 local SIP port 21
 log in address 14

M

microphone gain 15
 mounting an intercom 31

N

network activity, verifying 10
 network configuration of intercom 16
 network rate 4
 Network Setup 16

O

orange link light 10
 outbound proxy 21

P

packet time 3
 part number 4
 parts list 5
 password
 changing for web configuration access 18
 for SIP server login 22
 login 14
 restoring the default 13
 play audio locally (door sensor) 26
 play audio locally (intrusion sensor) 26
 play audio remotely (door sensor) 26
 play audio remotely (intrusion sensor) 26
 point-to-point configuration 23
 port
 local SIP 21
 remote SIP 21
 power requirement 4
 product
 configuring 13
 mounting 31
 parts list 5
 product features 3
 product overview
 product features 3
 product specifications 4
 supported protocols 3
 supported SIP servers 3
 typical system installation 2
 product specifications 4
 protocols supported 3

R

reboot 28, 30
 registration and expiration, SIP server lease 22
 relay

- activate during ring 19
- activate on button press 19
- on button press timeout 19
- remote SIP port 21
- reset test function management switch 11
- resetting the IP address to the default 31, 35
- restoring factory default settings 12, 37
- ringback tone
 - configuration 19
- RJ-45 8
- RMA returned materials authorization 35
- RTFM jumper 11, 12
- RTFM jumper switch 11
- RTFM switch 11, 12
- RTP/AVP 3

S

- server address, SIP 21
- setting up a TFTP server 34
- setting up an intercom 6
- settings, default 12
- SIP (session initiation protocol) 3
- SIP Configuration 21, 25
- SIP configuration
 - SIP Server 21
- SIP registration 22
- SIP server 21
 - SIP servers supported 3
- solarwinds 34
- speaker output 4
- speaker volume 15
- static IP addressing 16
- subnet mask 13, 16
- supported protocols 3

T

- technical support, contact information 35
- TFTP server 3, 34

U

- unregister, from SIP server 22
- user ID
 - for SIP server login 22
 - SIP 21
- username
 - changing for web configuration access 18
 - default for web configuration access 14
 - restoring the default 13

V

- verifying
 - baud rate 10
 - intercom operations 18
 - network activity 10
 - network connectivity 10

W

- warranty 36
- web access password 13
- web access username 13
- web configuration log in address 14
- web-based intercom configuration 13
- weight 4
- Windows, setting up a TFTP server on 34

Y

- yellow act light 10
- yellow link light 10