



Singlewire-enabled VoIP V2 Paging Amplifier Operations Guide

Part #011085
Document Part #930363D
for Firmware Version 1.2.3

CyberData Corporation
3 Justin Court
Monterey, CA 93940
(831) 373-2601

VoIP V2 Paging Amplifier Operations Guide 930363D
Part # 011085

COPYRIGHT NOTICE:

© 2013, CyberData Corporation, ALL RIGHTS RESERVED.

This manual and related materials are the copyrighted property of CyberData Corporation. No part of this manual or related materials may be reproduced or transmitted, in any form or by any means (except for internal use by licensed customers), without prior express written permission of CyberData Corporation. This manual, and the products, software, firmware, and/or hardware described in this manual are the property of CyberData Corporation, provided under the terms of an agreement between CyberData Corporation and recipient of this manual, and their use is subject to that agreement and its terms.

DISCLAIMER: Except as expressly and specifically stated in a written agreement executed by CyberData Corporation, CyberData Corporation makes no representation or warranty, express or implied, including any warranty or merchantability or fitness for any purpose, with respect to this manual or the products, software, firmware, and/or hardware described herein, and CyberData Corporation assumes no liability for damages or claims resulting from any use of this manual or such products, software, firmware, and/or hardware. CyberData Corporation reserves the right to make changes, without notice, to this manual and to any such product, software, firmware, and/or hardware.

OPEN SOURCE STATEMENT: Certain software components included in CyberData products are subject to the GNU General Public License (GPL) and Lesser GNU General Public License (LGPL) "open source" or "free software" licenses. Some of this Open Source Software may be owned by third parties. Open Source Software is not subject to the terms and conditions of the CyberData COPYRIGHT NOTICE or software licenses. Your right to copy, modify, and distribute any Open Source Software is determined by the terms of the GPL, LGPL, or third party, according to who licenses that software.

Software or firmware developed by CyberData that is unrelated to Open Source Software is copyrighted by CyberData, subject to the terms of CyberData licenses, and may not be copied, modified, reverse-engineered, or otherwise altered without explicit written permission from CyberData Corporation.

TRADEMARK NOTICE: CyberData Corporation and the CyberData Corporation logos are trademarks of CyberData Corporation. Other product names, trademarks, and service marks may be the trademarks or registered trademarks of their respective owners.



Technical Support

The fastest way to get technical support for your VoIP product is to submit a VoIP Technical Support form at the following website:
<http://www.cyberdata.net/support/contactsupportvoip.html>

Phone: (831) 373-2601, Ext. 333

Email: support@cyberdata.net

Fax: (831) 373-4193

Company and product information is at www.cyberdata.net.



Revision Information

Revision 930363D, released on April 24, 2013, corresponds to firmware version 1.2.3, and has the following changes:



- Updates [Section 1.5, "Product Specifications"](#).

Important Safety Instructions

1. Read these instructions.
2. Keep these instructions.
3. Heed all warnings.
4. Follow all instructions.
5. Do not use this apparatus near water.
6. Clean only with dry cloth.
7. Do not block any ventilation openings. Install in accordance with the manufacturer's instructions.
8. Do not install near any heat sources such as radiators, heat registers, stoves, or other apparatus (including amplifiers) that produce heat.
9. Do not defeat the safety purpose of the polarized or grounding-type plug. A polarized plug has two blades with one wider than the other. A grounding type plug has two blades and a third grounding prong. The wide blade or the third prong are provided for your safety. If the provided plug does not fit into your outlet, consult an electrician for replacement of the obsolete outlet.
10. Protect the power cord from being walked on or pinched particularly at plugs, convenience receptacles, and the point where they exit from the apparatus.
11. Only use attachments/accessories specified by the manufacturer.
12. Refer all servicing to qualified service personnel. Servicing is required when the apparatus has been damaged in any way, such as power-supply cord or plug is damaged, liquid has been spilled or objects have fallen into the apparatus, the apparatus has been exposed to rain or moisture, does not operate normally, or has been dropped.
13. Prior to installation, consult local building and electrical code requirements.

 <p>GENERAL ALERT</p>	<p>Warning <i>Electrical Hazard:</i> This product should be installed by a licensed electrician according to all local electrical and building codes.</p>
 <p>GENERAL ALERT</p>	<p>Warning <i>Electrical Hazard:</i> To prevent injury, this apparatus must be securely attached to the floor/wall in accordance with the installation instructions.</p>

Pictorial Alert Icons

	<p>General Alert</p> <p><i>This pictorial alert indicates a potentially hazardous situation. This alert will be followed by a hazard level heading and more specific information about the hazard.</i></p>
	<p>Ground</p> <p><i>This pictorial alert indicates the Earth grounding connection point.</i></p>

Hazard Levels

Danger: Indicates an imminently hazardous situation which, if not avoided, will result in death or serious injury. This is limited to the most extreme situations.

Warning: Indicates a potentially hazardous situation which, if not avoided, could result in death or serious injury.

Caution: Indicates a potentially hazardous situation which, if not avoided, could result in minor or moderate injury. It may also alert users against unsafe practices.

Notice: Indicates a statement of company policy (that is, a safety policy or protection of property).

The safety guidelines for the equipment in this manual do not purport to address all the safety issues of the equipment. It is the responsibility of the user to establish appropriate safety, ergonomic, and health practices and determine the applicability of regulatory limitations prior to use. Potential safety hazards are identified in this manual through the use of words *Danger*, *Warning*, and *Caution*, the specific hazard type, and pictorial alert icons.

Abbreviations and Terms

Abbreviation or Term	Definition
A-law	A standard companding algorithm, used in European digital communications systems to optimize, i.e., modify, the dynamic range of an analog signal for digitizing.
AVP	Audio Video Profile
Cat 5	TIA/EIA-568-B Category 5
DHCP	Dynamic Host Configuration Protocol
LAN	Local Area Network
LED	Light Emitting Diode
Mbps	Megabytes per Second.
NTP	Network Time Protocol
PBX	Private Branch Exchange
PoE	Power over Ethernet (as per IEEE 802.3af standard)
RTP	Real-time Transport Protocol
RTFM	Reset Test Function Management
SIP	Session Initiated Protocol
Talkback	Two-way communication enabled
TFTP	Trivial File Transfer Protocol
u-law	A companding algorithm, primarily used in the digital telecommunication
UC	Unified Communications
VoIP	Voice over Internet Protocol

Contents

Chapter 1 Product Overview	1
1.1 How to Identify This Product	1
1.2 Typical System Installation	2
1.3 Product Features	3
1.4 Supported Protocols	3
1.5 Product Specifications	4
Chapter 2 Installing the VoIP V2 Loudspeaker Amplifier	5
2.1 Parts List	5
2.2 Paging Amplifier Setup	6
2.2.1 Paging Amplifier Components	7
2.2.2 Connecting the Paging Amplifier	8
2.2.3 Paging Amplifier DIP Switches	10
2.2.4 VoIP V2 Loudspeaker Amplifier System Installation and Connection Options	11
2.2.5 Confirm Operation	13
2.2.6 Confirm the IP Address and Test the Audio	14
2.2.7 Adjust the Volume	15
2.3 Configure the Paging Amplifier Parameters	16
2.3.1 Paging Amplifier Web Page Navigation	17
2.3.2 Log in to the Configuration Home Page	17
2.3.3 Upgrade the Firmware and Reboot the Paging Amplifier	20
2.3.4 Reboot the Paging Amplifier	23
2.4 Identifying and Testing a Paging Amplifier when Using InformaCast 4.0 or Later	24
Appendix A Mounting the Amplifier	30
A.1 Mount the Paging Amplifier	30
Appendix B Setting up a TFTP Server	31
B.1 Set up a TFTP Server	31
B.1.1 In a LINUX Environment	31
B.1.2 In a Windows Environment	31
Appendix C Troubleshooting/Technical Support	32
C.1 Frequently Asked Questions (FAQ)	32
C.2 Documentation	32
C.3 Contact Information	33
C.4 Warranty	34
C.4.1 Warranty & RMA Returns within the United States	34
C.4.2 Warranty & RMA Returns Outside of the United States	34
C.4.3 Spare in the Air Policy	34
C.4.4 Return and Restocking Policy	35
C.4.5 Warranty and RMA Returns Page	35
Index	36

1 Product Overview

The Singlewire-enabled VoIP V2 Paging Amplifier provides an easy method for implementing an IP-based overhead paging system for both new and legacy installations.

With up to 25 watts of driving power (802.3at), the Amplifier provides direct drive of a standard Horn speaker and supports a line-out connector for connection to an external amplifier. The interface is compatible with Singlewire's InformaCast software.

Note The version of InformaCast needs to be 4.0 or higher.

Note Prior to installation, create a plan for the locations of your units.

	<p>General Alert Consult local building and electrical code requirements prior to installation.</p>
---	---

1.1 How to Identify This Product

To identify the VoIP V2 Loudspeaker Amplifier, look for a model number label similar to the one shown in [Figure 1-1](#). The model number on the label should be **011085**.

Figure 1-1. Model Number Label

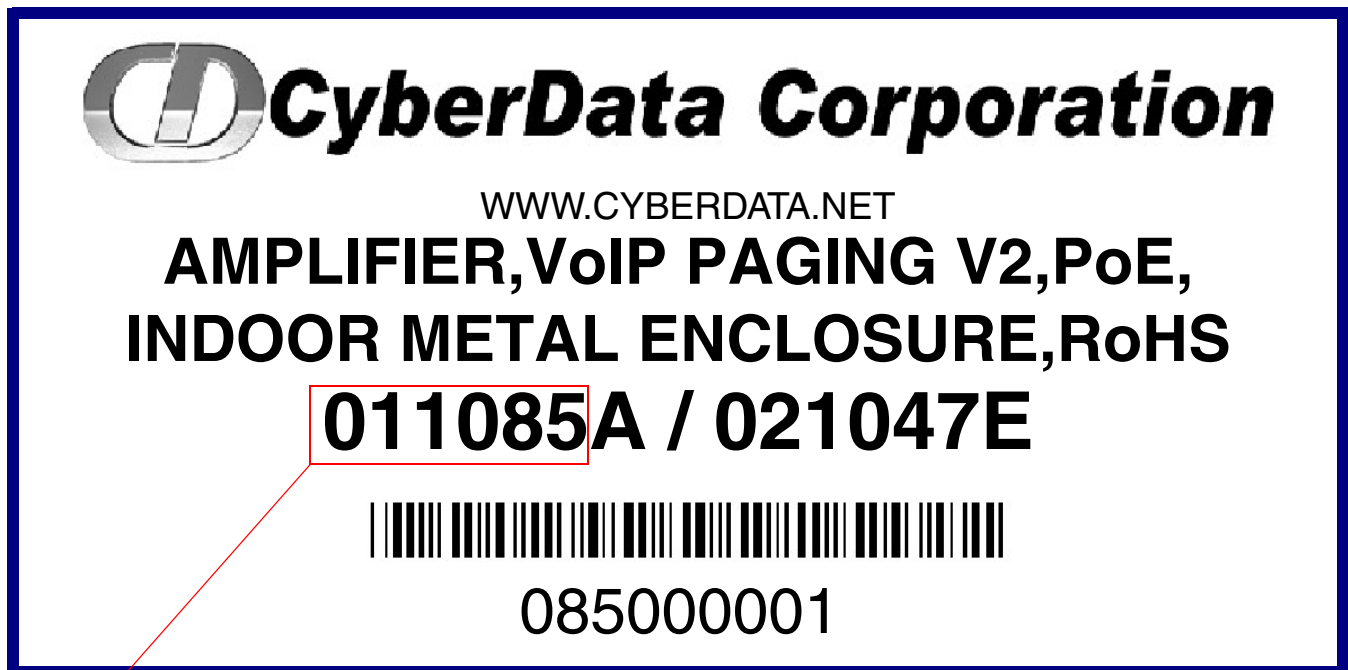

Model number

1.2 Typical System Installation

Figure 1-2 illustrates how the VoIP V2 Loudspeaker Amplifier is normally installed as part of a public address system.

Figure 1-2. Typical Installation

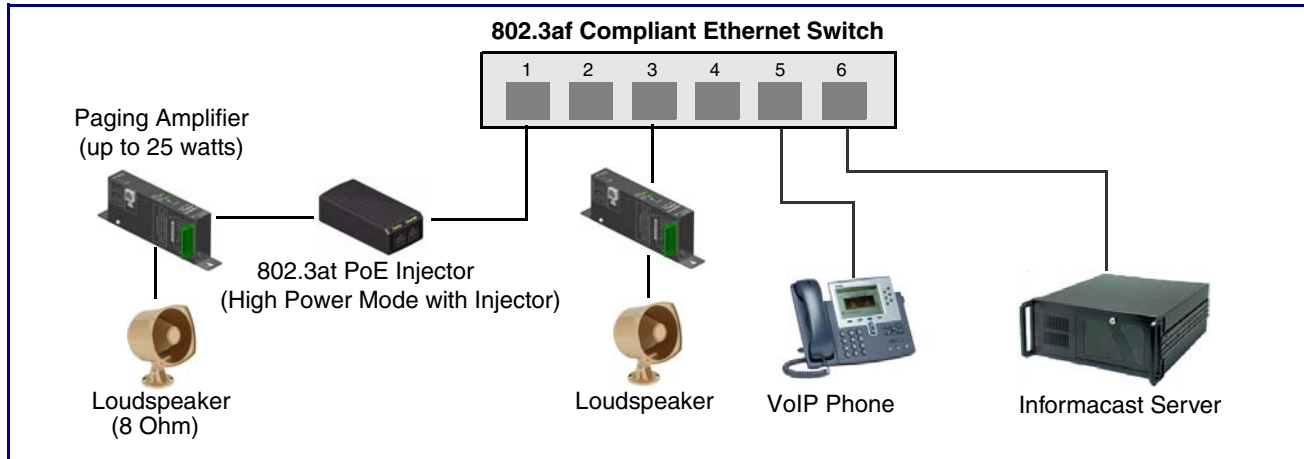

1.3 Product Features

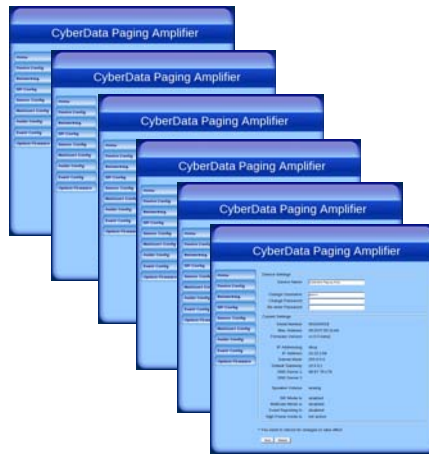

- InformaCast software compatible
- Dual-speed ethernet 10/100 Mbps
- Web-based configuration
- Web-based firmware upgradeable
- PoE 802.3af-enabled (Powered-over-Ethernet)
- Line-out connector
- Direct speaker drive
- Network and external speaker volume control

1.4 Supported Protocols

The Paging Amplifier supports:

- HTTP Web-based configuration

Provides an intuitive user interface for easy system configuration and verification of Paging Amplifier operations.

- DHCP Client

Dynamically assigns IP addresses in addition to the option to use static addressing.

- TFTP Client

Facilitates Web-based firmware upgrades of the latest Paging Amplifier capabilities.

- RTP
- RTP/AVP - Audio Video Profile
- SPEEX
- Audio Encodings
 - PCMU (G.711 mu-law)
 - PCMA (G.711 A-law)
 - Packet Time 20 ms

1.5 Product Specifications

Table 1. Product Specifications



Category	Specification
Ethernet I/F	10/100 Mbps
Power Input	PoE 802.3at or 802.3af
Operating Temperature	-10° C to 50° C (14° F to 122° F)
Protocol	SIP RFC 3261
Payload Types	G711, SPEEX
Warranty	2 Years Limited
Dimensions	1.26" x 9.45" x 3.13"
Audio Output	802.3af - up to 10 Watts (default, 50% duty cycle [one second on and one second off]). 802.3at - up to 22 Watts (default, 50% duty cycle [one second on and one second off])
Line Out:	
Output Signal Amplitudes	2.0 VPP maximum
Output Level	+2dBm nominal
Total Harmonic Distortion	0.5% maximum
Output Impedance	10k Ohm
IP Address Assignment	Static/DHCP
Transport Bandwidth	64 kbps for G711 70 kbps for L16
Audio Protocol	G711, L16
Audio Latency	*dependent upon network infrastructure
Protocol Support	InformaCast, UDP, IP, ARP, ICMP, IGMP, DHCP, RTP, RTP-AVP, HTTP, TFTP
Support Multicast	Yes
Diagnostics	Audio
Line Voltage Output to Speakers	Output Signal Amplitudes 2.0 VPP maximum Output Level +2dBm nominal Total Harmonic Distortion 0.5% maximum
Minimum Storage Ambient Temperature	-40 degrees C
Maximum Storage Ambient Temperature	70 degrees C
Minimum Operating Ambient Temperature	-30 degrees C
Maximum Operating Ambient Temperature	55 degrees C
Part Number	011085

2 Installing the VoIP V2 Loudspeaker Amplifier

2.1 Parts List

Table 2-1 illustrates the parts for each Paging Amplifier and includes a kit for mounting.

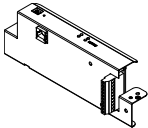
Table 2-1. Parts List

Quantity	Part Name	Illustration
1	Paging Amplifier Assembly	
1	Installation Quick Reference Guide	
1	Paging Amplifier Mounting Accessory Kit, RoHS (part #071057A) which includes: (2) Plastic Ribbed Anchors (2) #6 Sheet Metal Screws	

2.2 Paging Amplifier Setup

Set up and configure each Paging Amplifier *before* you mount it.

CyberData delivers each Paging Amplifier with the factory default values indicated in [Table 2-2](#):

Table 2-2. Factory Default Settings—Default of Network

Parameter	Factory Default Setting
IP Addressing	DHCP
IP Address ^a	10.10.10.10
Web Access Username	admin
Web Access Password	admin
Subnet Mask ^a	255.0.0.0
Default Gateway ^a	10.0.0.1

a. Default if there is not a DHCP server present.

2.2.1 Paging Amplifier Components

Figure 2-3 shows the components of the Paging Amplifier .

Figure 2-3. Paging Amplifier Components

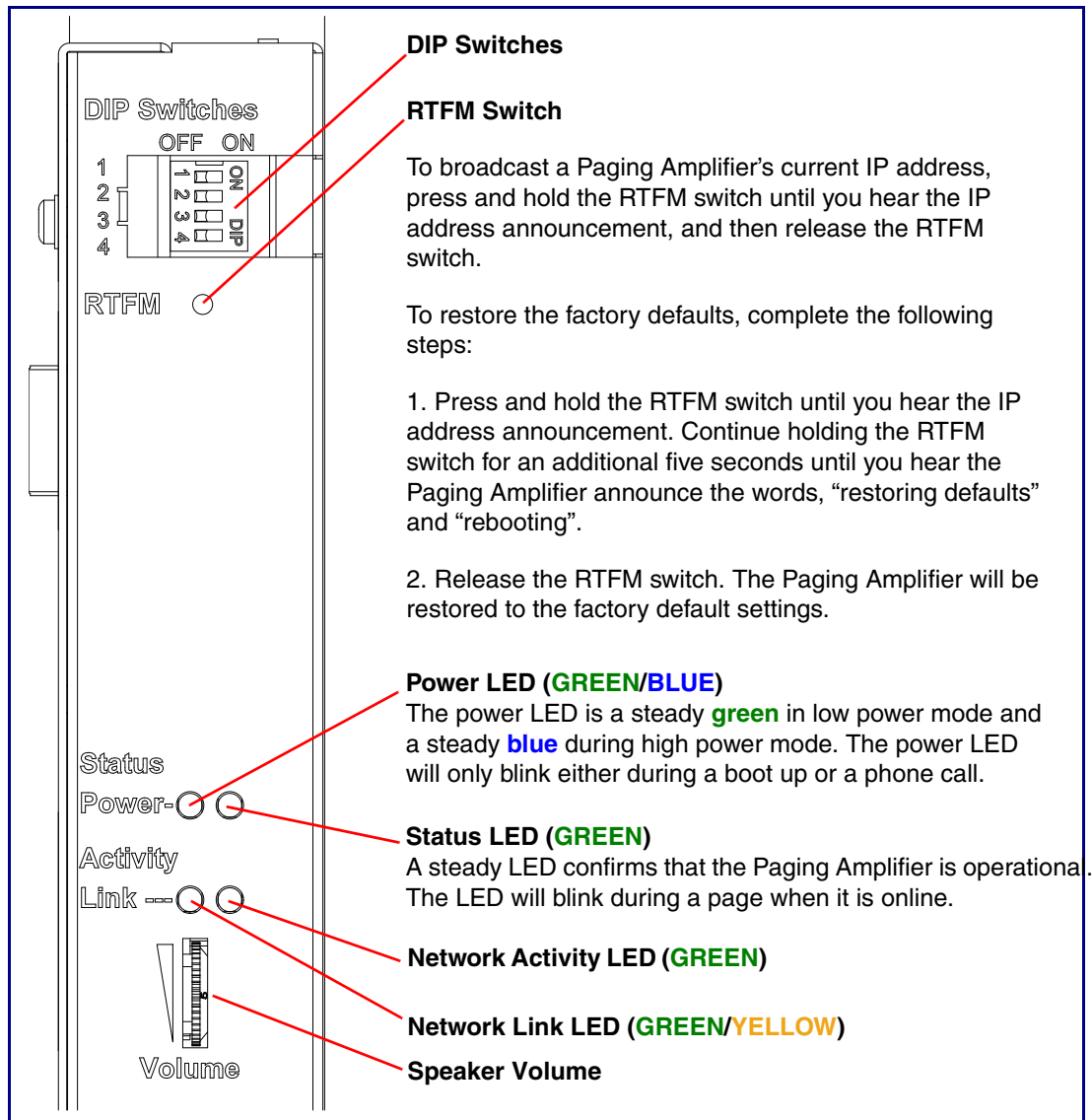

2.2.2 Connecting the Paging Amplifier

2.2.2.1 Using the Amplified Outputs

Figure 2-4 and Figure 2-5 illustrates how to connect the VoIP V2 Loudspeaker Amplifier and use the amplified outputs in low and high power mode.

Low Power Mode

Figure 2-4. Using the Amplified Outputs—Low Power Mode

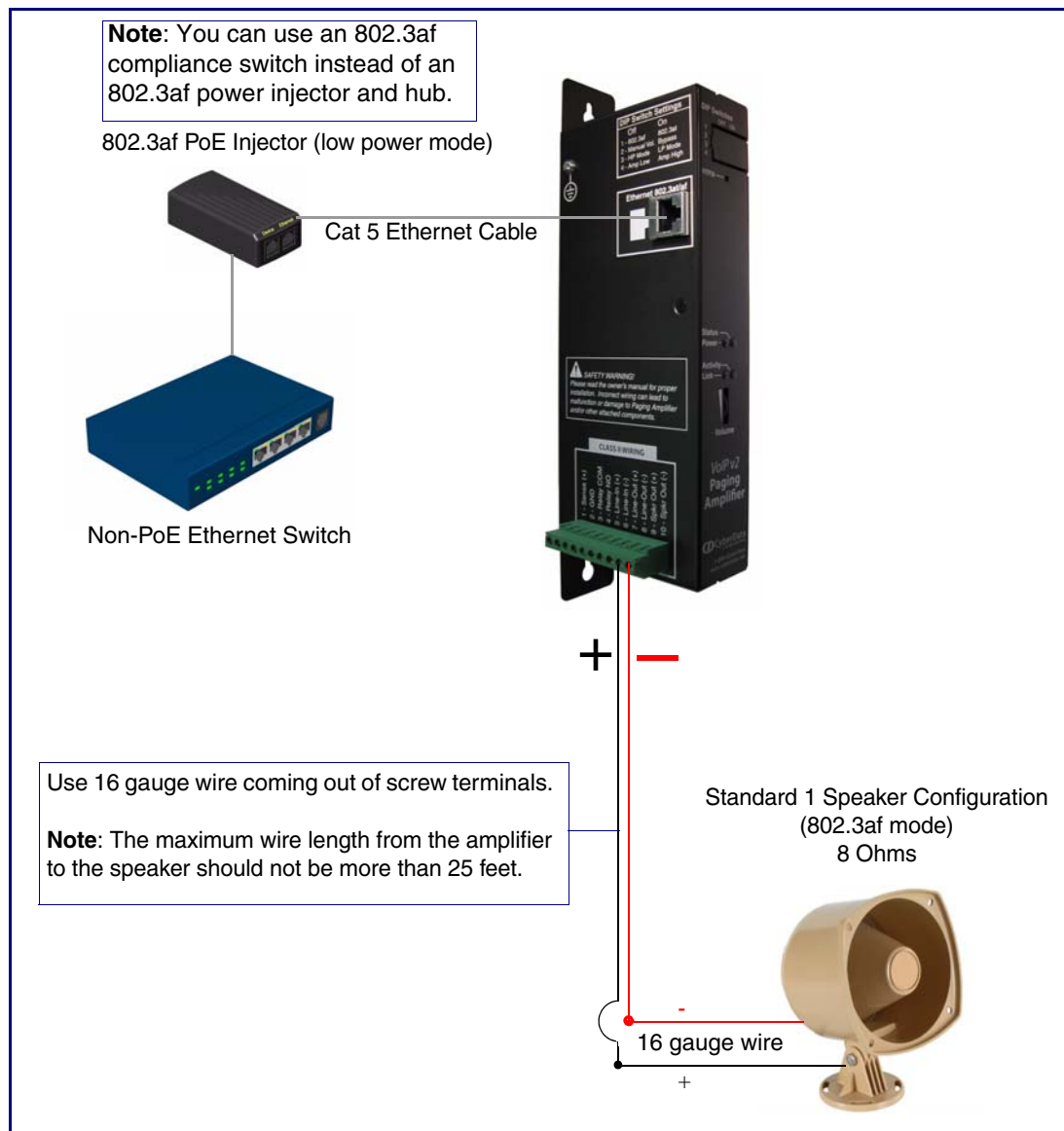

High Power Mode

Figure 2-5. Using the Amplified Outputs—High Power Mode

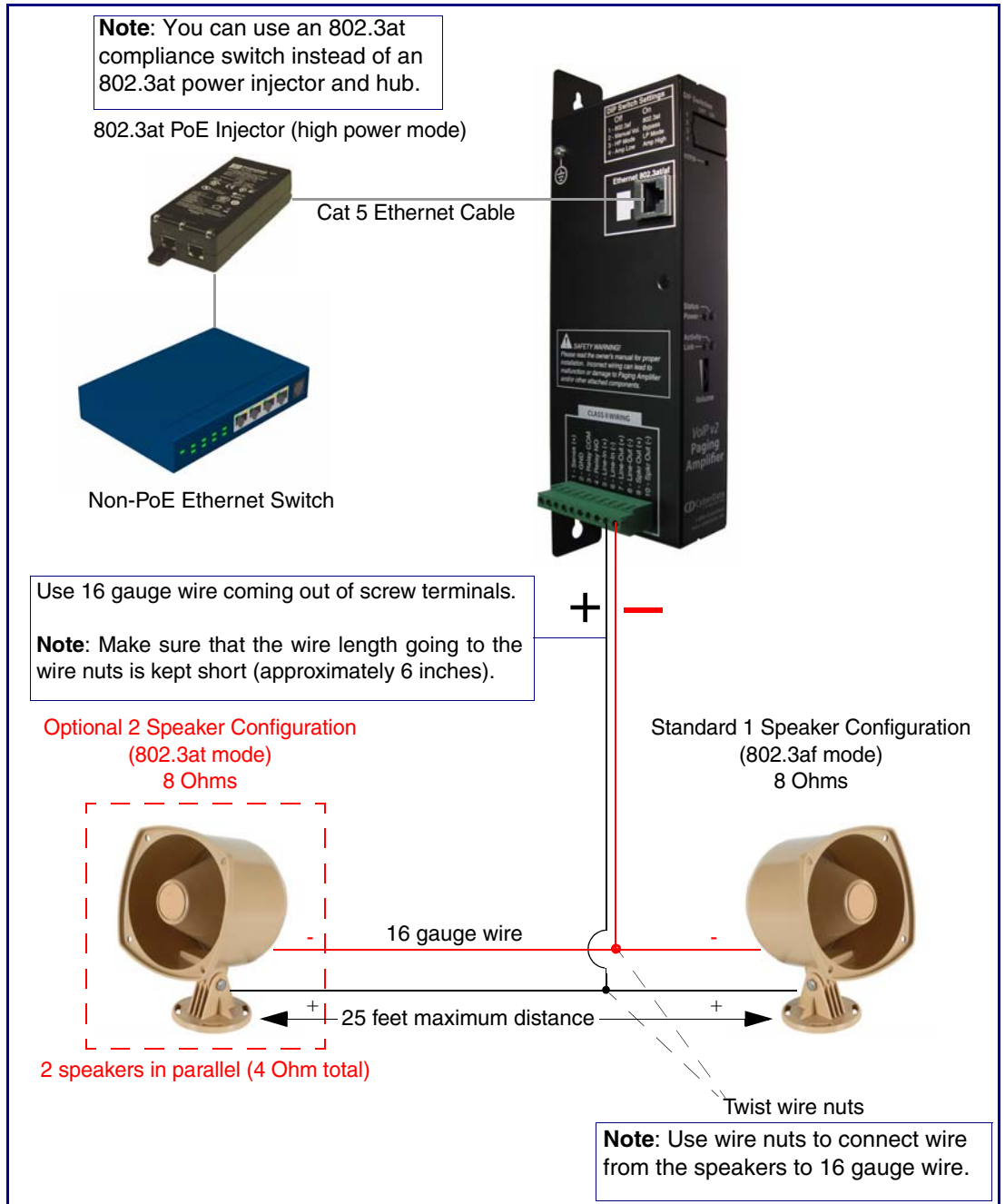

2.2.3 Paging Amplifier DIP Switches

See [Figure 2-6](#) to identify the DIP Switches.

Figure 2-6. DIP Switches

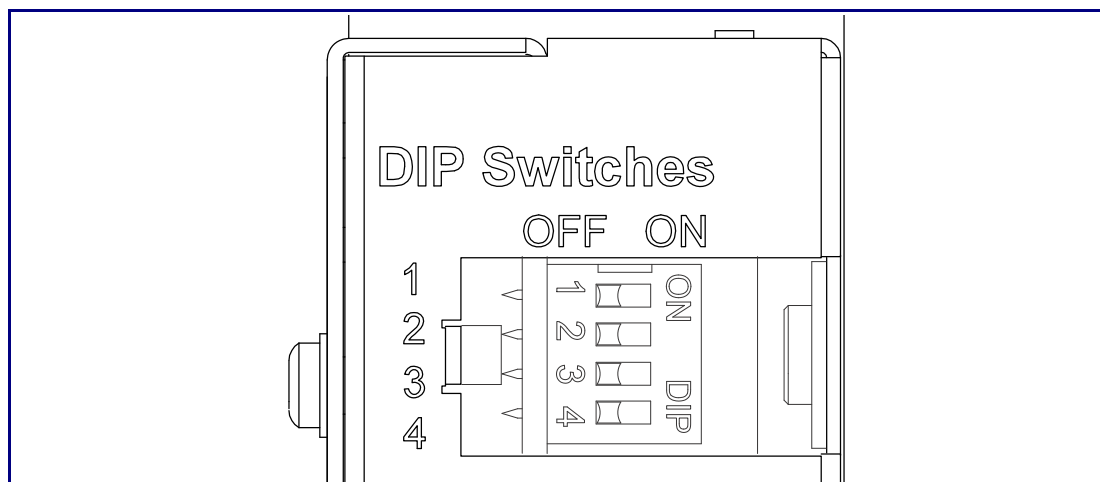

See the following tables for the DIP Switch settings:

Table 2-3. DIP Switch Settings—Low Power—802.3af Compliant

DIP Switch	Default Setting	Description
1	OFF	Sets PoE for 802.3af class.
2	N/A	Not applicable for power setting.
3	ON	Switch mode current set to LOW .
4	OFF	Low gain amplifier setting.

Table 2-4. DIP Switch Settings—High Power—802.3at Compliant^a

DIP Switch	Setting	Description
1	ON	Sets PoE for 802.3at class.
2	N/A	Not applicable for power setting.
3	OFF	Switch mode current set to HIGH .
4	ON	Force high gain amplifier.

a. If set to high power, the unit will not power ON with 802.3af compliant switch. You must use a power injector in this mode (CyberData Part Number 011124). High power PoE mode conforms to IEEE 802.3at draft 3.0.

Table 2-5. DIP Switch 2 Settings

DIP Switch	Setting	Description
2	OFF	Manual Vol. The speaker volume is set manually by the analog volume trimmer.
2	ON	Bypass. Bypasses the manual volume control of the analog volume trimmer and uses the web page volume settings.

2.2.4 VoIP V2 Loudspeaker Amplifier System Installation and Connection Options

Figure 2-7 through Figure 2-8 illustrates connection options for the VoIP V2 Loudspeaker Amplifier.

Figure 2-7. V2 Paging Amplifier Connections

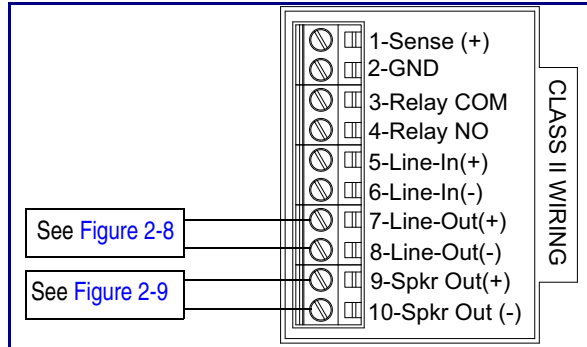

Figure 2-8. Line Out Connection

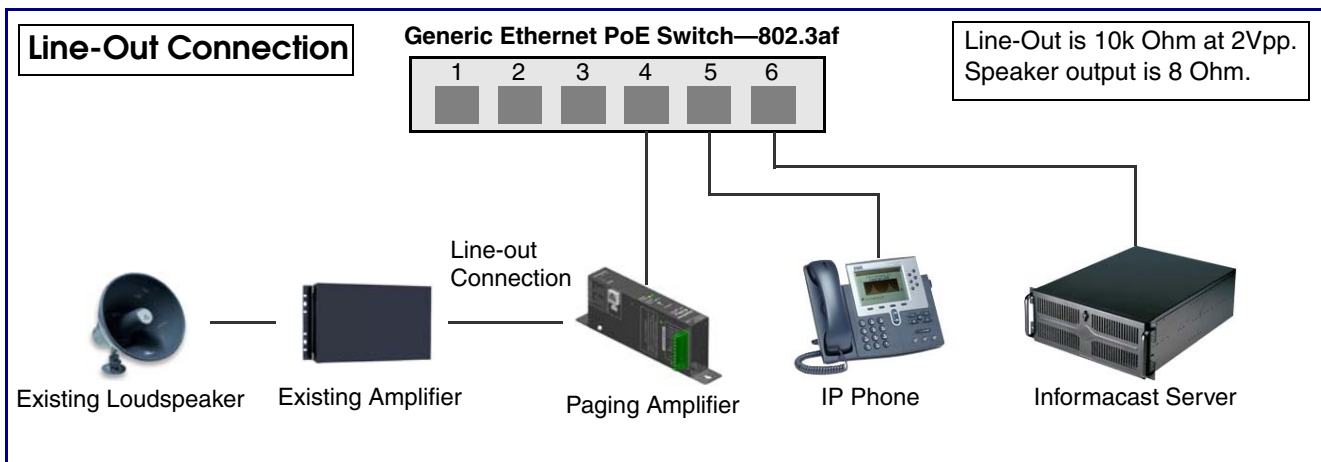
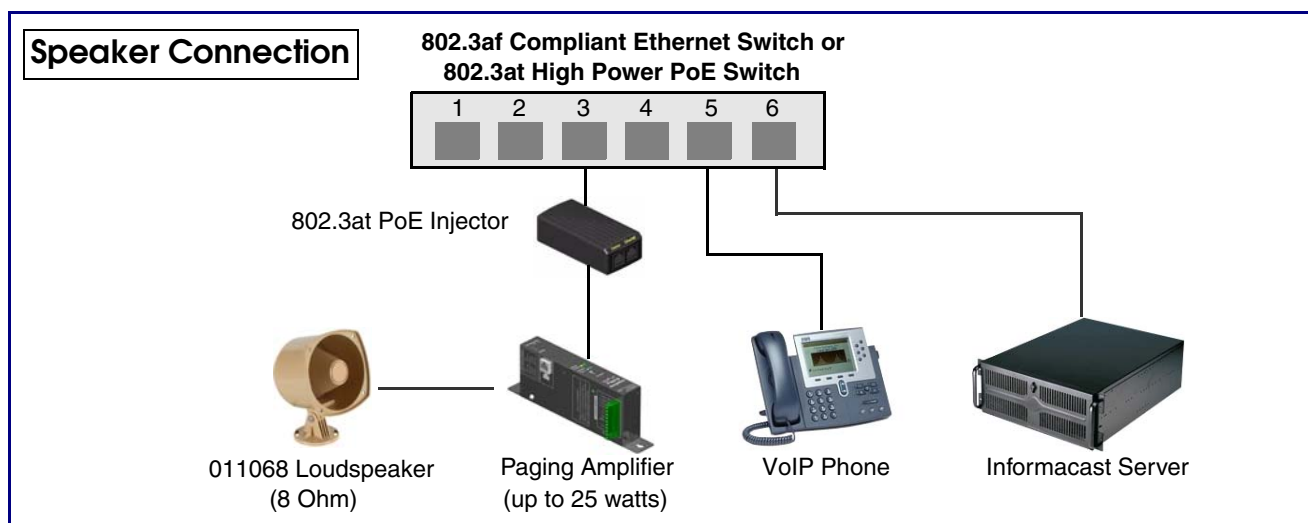

Figure 2-9. Speaker Out Connection



See [Table 2-6](#) for details about the Paging Amplifier connections.

Table 2-6. Paging Amplifier Connections

Connection	Connection Details	Location
Ethernet	<ul style="list-style-type: none"> Use a RJ 45 cable. 	VoIP V2 Paging Amplifier

2.2.4.1 Loudspeaker Type

Using the amplified output, the CyberData VoIP V2 Loudspeaker Amplifier supports the 011068 Loudspeaker or equivalent unamplified loudspeaker.

Figure 2-10. 011068 Loudspeaker



2.2.4.2 Cabling/Wiring

Using the amplified output, you may connect a loudspeaker to a Paging Amplifier with a good quality speaker cable that is limited to 25 feet in length.

2.2.5 Confirm Operation

After connecting the Paging Amplifier to the ethernet hub, use the LEDs on the Paging Amplifier face to confirm that the Paging Amplifier is operational and linked to the network.

Table 2-7. Paging Amplifier LEDs

LED	Color	Function
Power	Blue/Green	The power LED is illuminated a steady green when the power is on and in low power mode. The power LED is illuminated a steady blue when the amplifier is in high power mode. The power LED will blink during a boot up or a phone call.
Status	Green	After supplying power to the Paging Amplifier, a steady LED confirms that the Paging Amplifier is operational. The status LED will blink during a page when it is online.
Link	Green/Yellow	The Link LED is illuminated green for a 10Mb link or yellow/green for a 100Mb link when the network link to the Paging Amplifier is established.
Activity	Green	The Activity LED blinks to indicate network traffic.

Figure 2-11. Paging Amplifier LEDs—Power and Link

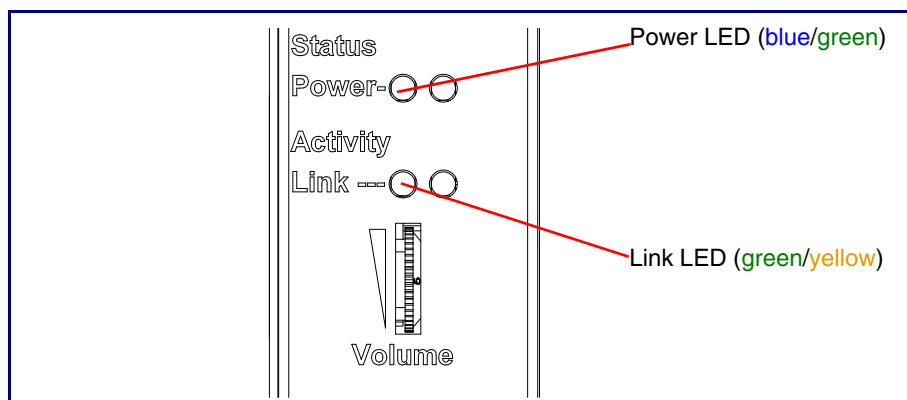
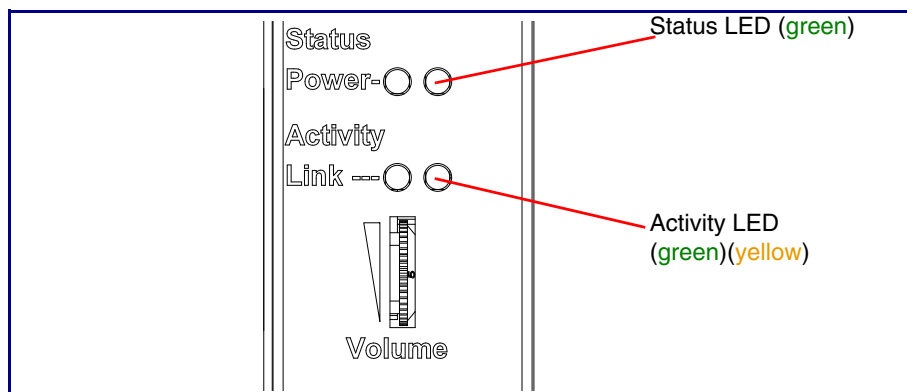

Figure 2-12. Paging Amplifier LEDs—Status and Activity



2.2.6 Confirm the IP Address and Test the Audio

2.2.6.1 RTFM Switch

When the Paging Amplifier is operational and linked to the network, use the Reset Test Function Management (RTFM) switch (Figure 2-13) on the Paging Amplifier face to announce and confirm the Paging Amplifier's IP Address, and test that the audio is working.

Figure 2-13. RTFM Switch

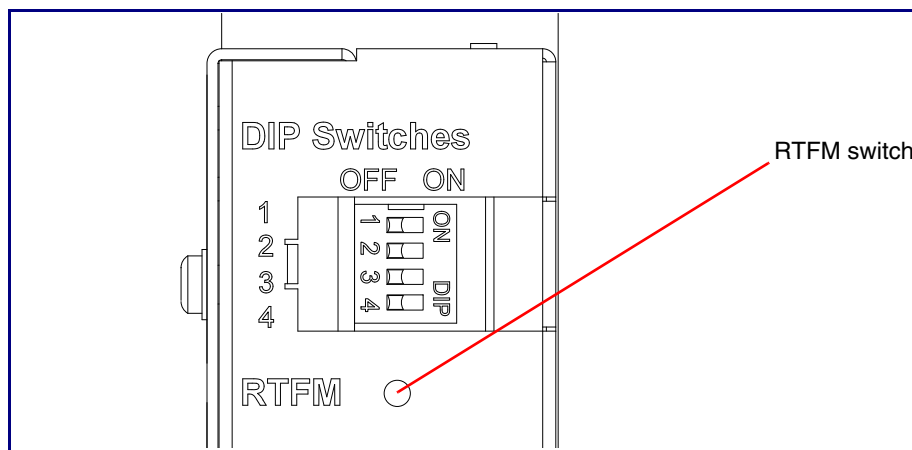

Announcing the IP Address To announce a Paging Amplifier's current IP address:

1. Press and hold the RTFM switch until you hear the IP address announcement.
2. Release the RTFM switch.



Caution

Equipment Caution: Pressing and holding the RTFM switch for more than five seconds after the IP address announcement will restore the V2 Paging Amplifier to the factory default settings. See the [“Restoring the Factory Default Settings”](#) section.

Restoring the Factory Default Settings

To restore the factory default settings, complete the following steps:

1. Press and hold the RTFM switch until you hear the IP address announcement. Continue holding the RTFM switch for an additional five seconds until you hear the Paging Amplifier announce the words, “restoring defaults” and “rebooting”.
2. Release the RTFM switch. The Paging Amplifier will be restored to the factory default settings.

2.2.7 Adjust the Volume

2.2.7.1 External Volume Dial

To adjust the Paging Amplifier volume, turn the external **Volume** dial (Figure 2-14) on the Paging Amplifier face.

Note For the lineout volume, the volume is fixed and the volume control is adjusted through an external amplifier.

Figure 2-14. External Volume Dial

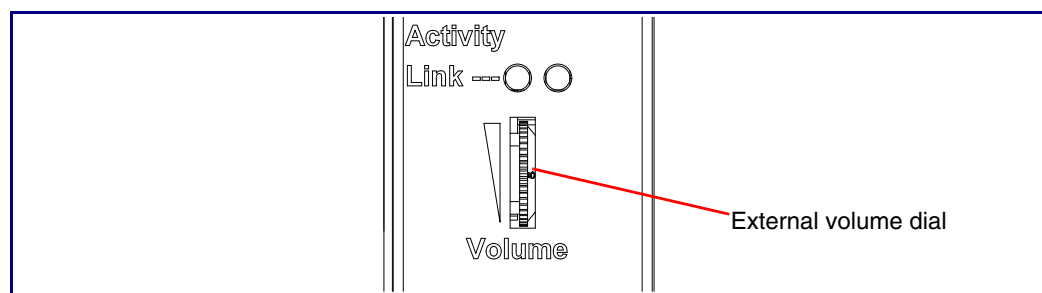

2.3 Configure the Paging Amplifier Parameters

To configure the Paging Amplifier online, use a standard web browser.

Configure each Paging Amplifier and verify its operation *before* you mount it. When you are ready to mount a Paging Amplifier enclosure, refer to [Appendix A, "Mounting the Amplifier"](#) for instructions.

All Paging Amplifier are initially configured with the default IP settings indicated in [Table 2-8](#).

When configuring more than one Paging Amplifier, attach the Paging Amplifiers to the network one at a time to avoid IP address conflicts.

Table 2-8. Factory Default Settings



Parameter	Factory Default Setting
IP Addressing	DHCP
IP Address ^a	10.10.10.10
Web Access Username	admin
Web Access Password	admin
Subnet Mask ^a	255.0.0.0
Default Gateway ^a	10.0.0.1

a. Default if there is not a DHCP server present.

2.3.1 Paging Amplifier Web Page Navigation

Table 2-9 shows the navigation buttons that you will see on every Paging Amplifier web page.

Table 2-9. V2 Paging Amplifier Web Page Navigation

Web Page Item	Description
	Link to the Home page.
	Link to the Update Firmware page.

2.3.2 Log in to the Configuration Home Page

1. Open your browser to the Paging Amplifier IP address.

Note If the network does not have access to a DHCP server, the device will default to an IP address of 10.10.10.10.

Note Make sure that the PC is on the same IP network as the Paging Amplifier.

Note You may also download CyberData's VoIP Discovery Utility program which allows you to easily find and configure the default web address of the CyberData VoIP products.

CyberData's VoIP Discovery Utility program is available on the VoIP V2 Loudspeaker Amplifier product page at:

http://www.cyberdata.net/support/voip/discovery_utility.html

The Paging Amplifier ships in DHCP mode. To get to the **Home** page, use the discovery utility to scan for the device on the network and open your browser from there.

2. When prompted, use the following default **Web Access Username** and **Web Access Password** to access the **Home Page** (Figure 2-15):

Web Access Username: **admin**

Web Access Password: **admin**

Figure 2-15. Home Page

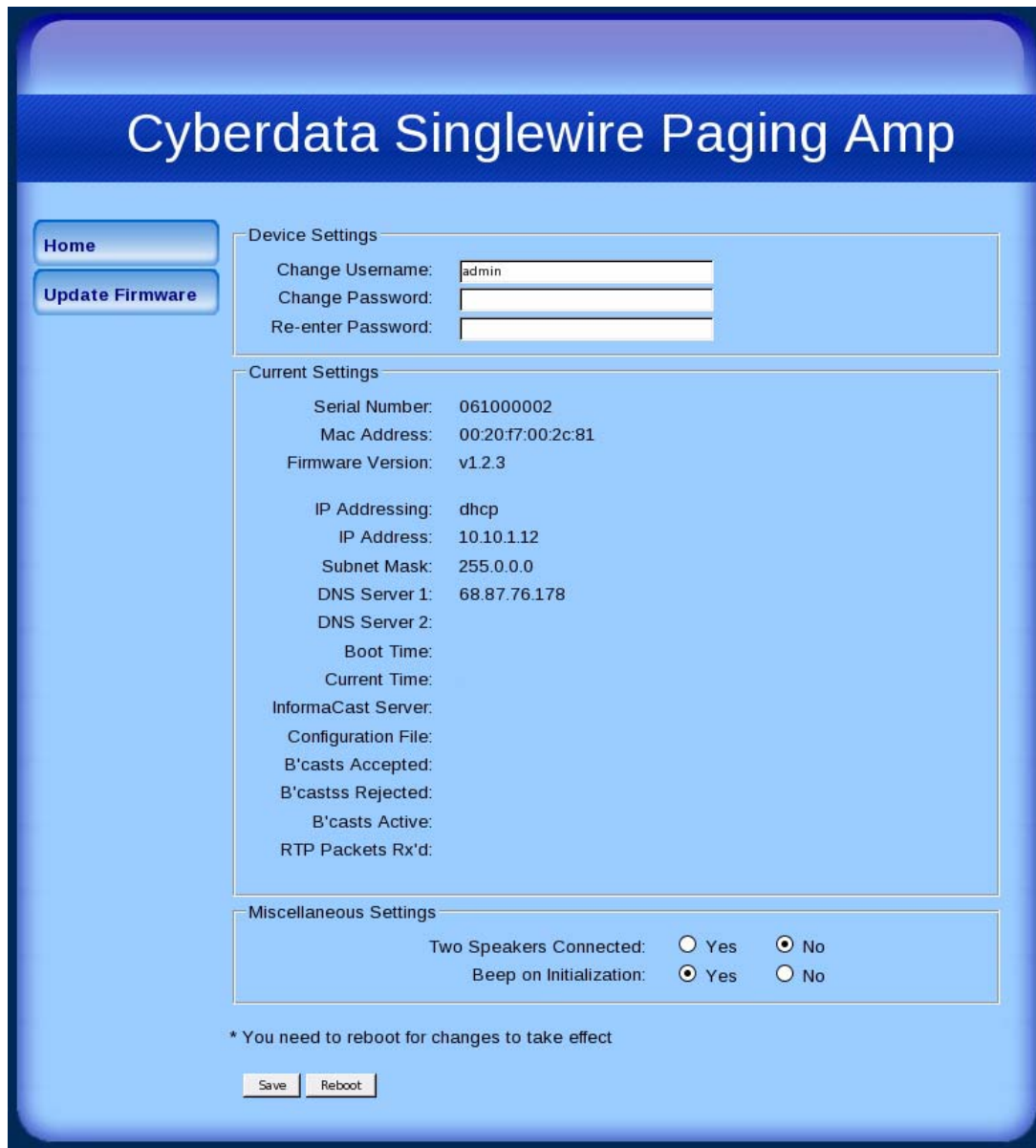

Note Figure 2-15 shows the factory default settings.

3. On the **Home Page**, review the setup details and navigation buttons described in [Table 2-10](#).

Table 2-10. Home Page Overview

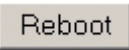
Web Page Item	Description
Device Settings	
Device Name	Shows the device name (25 character limit).
Change Username	Type in this field to change the username (25 character limit).
Change Password	Type in this field to change the password (19 character limit).
Re-enter Password	Type the password again in this field to confirm the new password (19 character limit).
Current Settings	
Serial Number	Shows the device serial number.
Mac Address	Shows the device Mac address.
Firmware Version	Shows the current firmware version.
IP Addressing	Shows the current IP addressing setting (DHCP or Static).
IP Address	Shows the current IP address.
Subnet Mask	Shows the current subnet mask address.
Default Gateway	Shows the current default gateway address.
DNS Server 1	Shows the current DNS Server 1 address.
DNS Server 2	Shows the current DNS Server 2 address.
Boot Time	Shows the boot time.
Current Time	Shows the current time.
InformaCast Server	Shows the InformaCast Server IP address.
Configuration File	Shows the configuration file.
B'casts Accepted	Shows the number of B'casts accepted.
B'casts Rejected	Shows the number of B'casts rejected.
B'casts Rejected	Shows the number of active B'casts.
RTP Packets Rx'd	Shows the number of RTP packets Rx'd.
Miscellaneous Settings	
Two Speakers Connected	Select either Yes or No to indicate whether you have two speakers connected.
Beep on Initialization	Select either Yes or No to indicate if you want to hear a beep when the unit is powered up.
	Click the Save button to save your configuration settings. Note: You need to reboot for changes to take effect.
	Click on the Reboot button to reboot the system.

2.3.3 Upgrade the Firmware and Reboot the Paging Amplifier

To upload the Paging Amplifier firmware from your PC:

1. Set up a TFTP server.
If you do not already have a TFTP server running on your network, see [Appendix B, "Setting up a TFTP Server"](#).
2. Retrieve the latest Paging Amplifier firmware from the VoIP V2 Loudspeaker Amplifier **Downloads** page at:
<http://www.cyberdata.net/products/voip/digitalanalog/singlewirepagingampv2/downloads.html>
3. Unzip the Paging Amplifier version file. This file may contain the following:
 - Firmware file
 - Release notes
4. Copy the firmware files to be upgraded to the appropriate TFTP server directory:
 - c:\tftp-root\for Windows
 - /tftpboot/for Linux
5. Log in to the Paging Amplifier home page as instructed in [Section 2.3.2, "Log in to the Configuration Home Page"](#).

6. Click the **Update Firmware** button to open the **Upgrade Firmware** page. See [Figure 2-16](#).

Figure 2-16. Firmware Upgrade Page

Cyberdata Singlewire Paging Amp

Home Upgrade Firmware

Update Firmware Firmware Version: v1.2.3

TFTP Server IP: 10.0.1.14

New Filename:

System will automatically reboot after upgrading firmware

Submit Reboot

Note [Figure 2-16](#) shows the factory default settings.

7. Enter the IP address of your TFTP server into the **TFTP Server IP** parameter field.
8. Enter the firmware filename of the file to be uploaded into the **New Filename** parameter field.
For example, kernel filename **100-uImage-pagingamp.bin**.
9. Click **Upload File**.

Note This starts the upload process. Once the Paging Amplifier has uploaded the file, the **Uploading Firmware** countdown page appears, indicating that the firmware is being written to flash. The Paging Amplifier will automatically reboot when the upload is complete. When the countdown finishes, the **Upgrade Firmware** page will refresh. The uploaded firmware filename should be displayed in the system configuration (indicating successful upload and reboot).

Table 2-11 shows the web page items on the **Upgrade Firmware** page.

Table 2-11. Firmware Upgrade Parameters

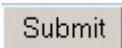
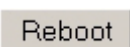
Web Page Item	Description
Firmware Version	Shows the current firmware version.
TFTP Server IP address	Enter the IP address of your TFTP server into the TFTP Server IP parameter field (15 character limit).
New Filename	Use this field to enter the new file name for the firmware file that you are uploading (25 character limit).
	Click on the Submit button to automatically upload the selected firmware and reboot the system.
	Click on the Reboot button to reboot the system.

2.3.4 Reboot the Paging Amplifier

To reboot a Paging Amplifier, log in to the web page as instructed in [Section 2.3.2, "Log in to the Configuration Home Page"](#).

1. Click **Update Firmware** to open the **Upgrade Firmware** page ([Figure 2-17](#)).

Figure 2-17. Reboot System Section

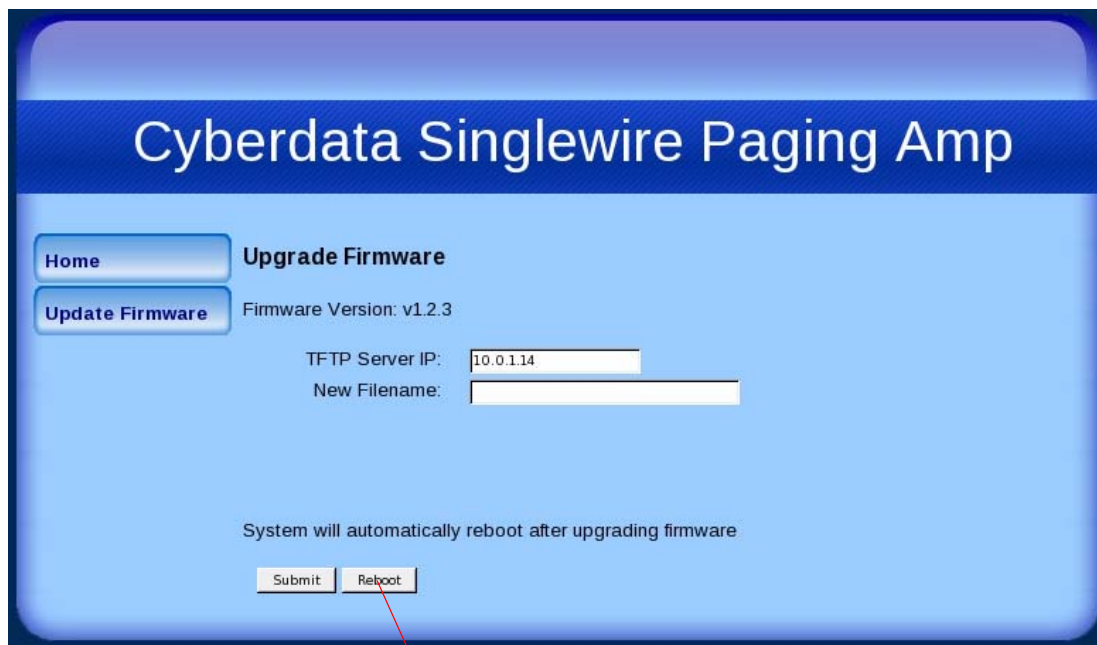

Reboot

2. Click **Reboot**. A normal restart will occur and you will see the following Reboot page.

Figure 2-18. Reboot Page



2.4 Identifying and Testing a Paging Amplifier when Using InformaCast 4.0 or Later

This section describes the basic process for identifying and testing the CyberData Paging Amplifier when using Singlewire's InformaCast software version 4.0 or later.

Note If you have questions or need help, please consult your InformaCast documentation and or contact the CyberData support team.

Note CyberData's support is limited to IP endpoint functionality when used with an InformaCast system.

To add the Paging Amplifier to the InformaCast server:

1. Click **Edit IP Speakers** on the **Main Screen** of the **Singlewire Informacast Server Web Interface**.

Figure 2-19. Main Screen of the Singlewire InformaCast Server Web Interface

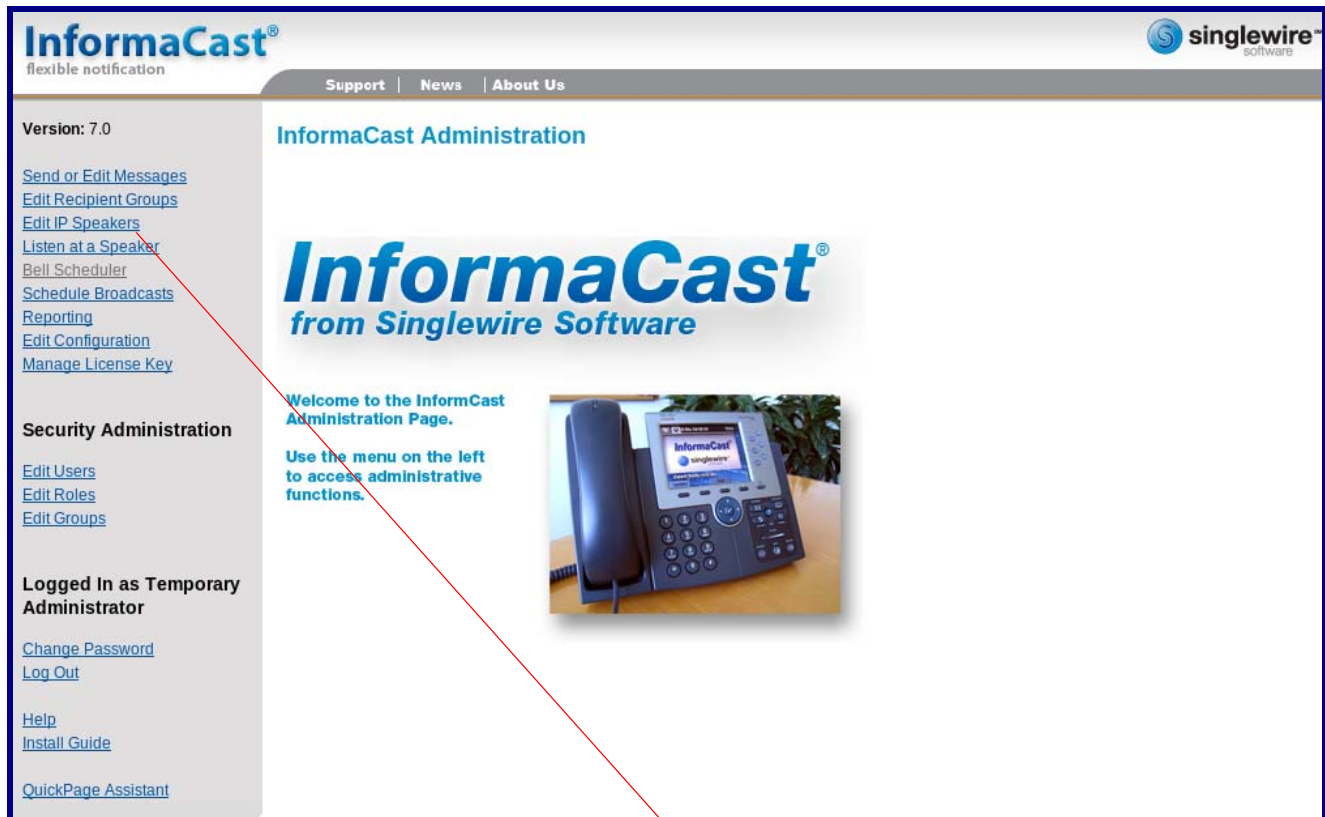

Edit IP Speakers

2. On the **IP Speaker Configuration** page, InformaCast will indicate that it has detected new units. Click **View**.

Figure 2-20. IP Amplifier Configuration Page

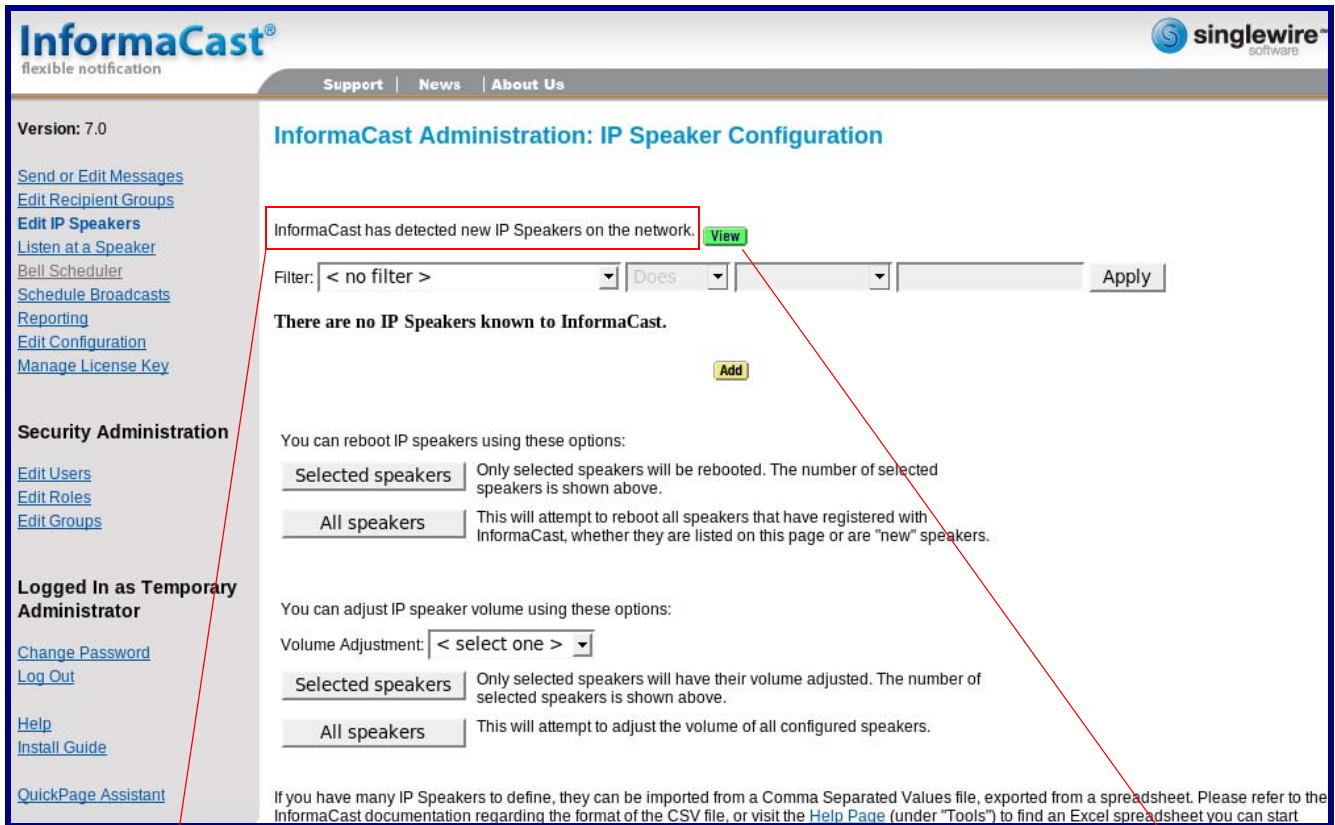

InformaCast has detected new Speakers.

View

3. The **IP Speaker Configuration** page will show four newly detected units. Click **Test**.

Figure 2-21. IP Speaker Configuration Page

The screenshot displays the InformaCast Administration interface for IP Speaker Configuration. The page title is "InformaCast Administration: IP Speaker Configuration". On the left sidebar, there are navigation links for "Send or Edit Messages", "Edit Recipient Groups", "Edit IP Speakers", "Listen at a Speaker", "Bell Scheduler", "Schedule Broadcasts", "Reporting", "Edit Configuration", and "Manage License Key". Below these are sections for "Security Administration" (Edit Users, Edit Roles, Edit Groups) and "Logged In as Temporary Administrator" (Change Password, Log Out, Help, Install Guide, QuickPage Assistant). The main content area shows a table with the following data:

MAC address	Registration Status	Action
0020f7002dc2	Registered at Thu Dec 17 12:05:55 GMT-07:00 2009 (can record), IP=10.10.1.190	Add Test
0020f7002dc3	Registered at Thu Dec 17 12:05:52 GMT-07:00 2009 (can record), IP=10.10.0.192	Add Test
0020f7002dc4	Registered at Thu Dec 17 12:06:12 GMT-07:00 2009 (can record), IP=10.10.1.191	Add Test
0020f7002dc5	Registered at Thu Dec 17 12:05:59 GMT-07:00 2009 (can record), IP=10.10.0.193	Add Test

Below the table, there is a "View" button followed by the text "configured speakers." A red arrow originates from the "Test" button in the first row of the table and points to the word "Test" located below the screenshot.

Test

4. On the **Test IP Speaker** page, Enter a number into the **Test duration** field.
5. Click **Test**.
6. You will hear a tone from the unit being testing.
7. After the test, click **Cancel** to return to the **IP Configuration** page.

Figure 2-22. Test IP Speaker Page

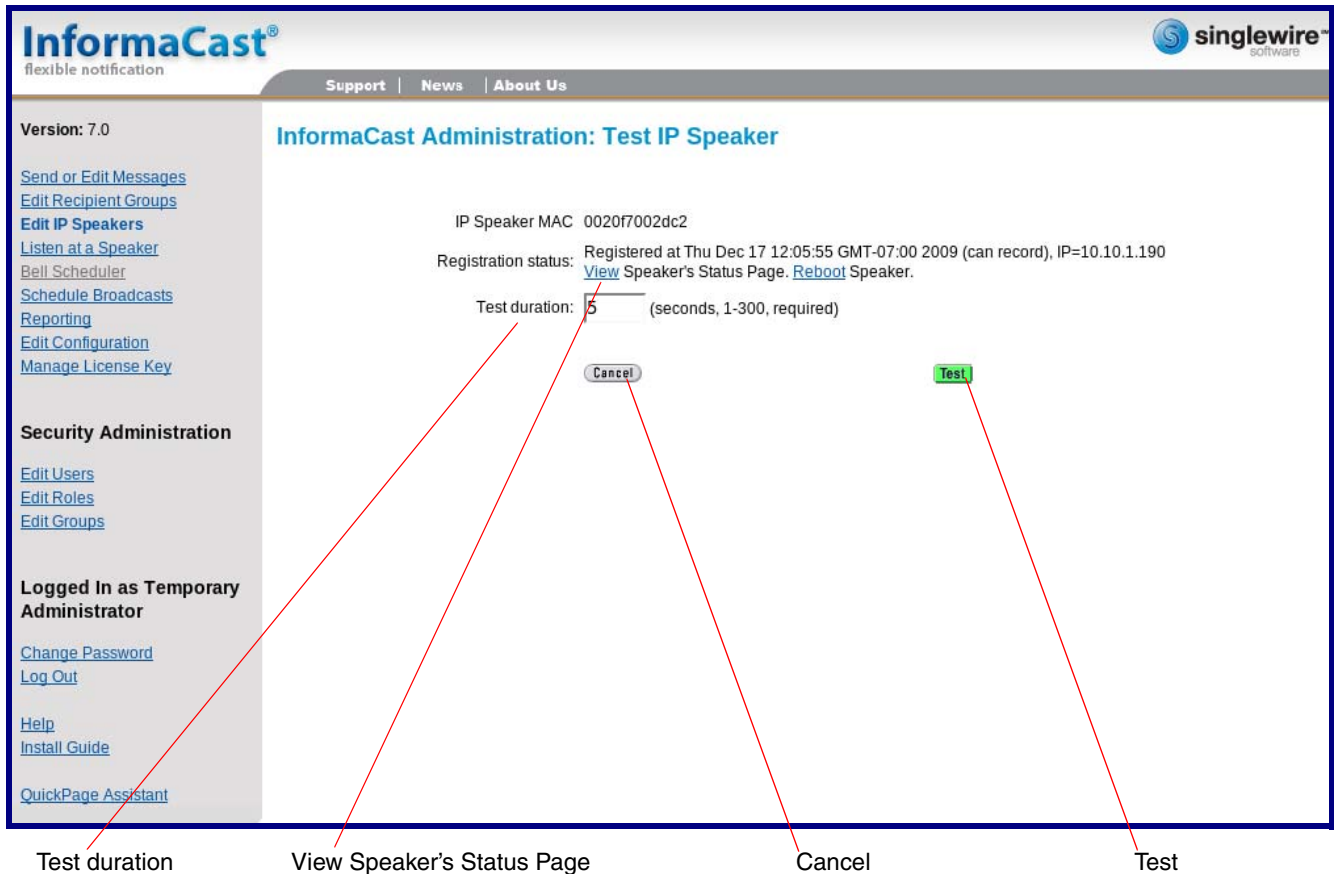

Note When viewing the unit's status page via Informacast, Informacast links to the wrong port and path.

Informacast expects our unit's status page to be at:

<http://<ipaddr>:10004/status>.

The status page is actually at:

[http://<ipaddr>/ \(port 80\)](http://<ipaddr>/ (port 80))

Therefore, if a user clicks the link to view the status page and is directed to:

<http://10.10.10.10:1004/status>

The user will need to edit the url in the address bar to:

<http://10.10.10.10/>

8. On the **IP Speaker Configuration** page, Click **Add** to add a Paging Amplifier to the InformaCast server.

Figure 2-23. IP Configuration Page

The screenshot displays the InformaCast Administration interface for IP Speaker Configuration. The page title is "InformaCast Administration: IP Speaker Configuration". On the left sidebar, there are navigation links for "Send or Edit Messages", "Edit Recipient Groups", "Edit IP Speakers", "Listen at a Speaker", "Bell Scheduler", "Schedule Broadcasts", "Reporting", "Edit Configuration", and "Manage License Key". Below these are sections for "Security Administration" (Edit Users, Edit Roles, Edit Groups) and "Logged In as Temporary Administrator" (Change Password, Log Out, Help, Install Guide, QuickPage Assistant). The main content area shows a table of registered speakers:

MAC address	Registration Status	Action
0020f7002dc2	Registered at Thu Dec 17 12:05:55 GMT-07:00 2009 (can record), IP=10.10.1.190	Add Test
0020f7002dc3	Registered at Thu Dec 17 12:05:52 GMT-07:00 2009 (can record), IP=10.10.0.192	Add Test
0020f7002dc4	Registered at Thu Dec 17 12:06:12 GMT-07:00 2009 (can record), IP=10.10.1.191	Add Test
0020f7002dc5	Registered at Thu Dec 17 12:05:59 GMT-07:00 2009 (can record), IP=10.10.0.193	Add Test

Below the table, there is a green "View" button followed by the text "configured speakers." A red arrow originates from the "Add" button in the table and points to the "Add" label located below the screenshot.

Add

9. On the **Add IP Speaker** page, Fill out appropriate fields and click **Add**.

Figure 2-24. Add IP Speaker Page

The screenshot displays the InformaCast Administration interface for adding a new IP speaker. The page title is "InformaCast Administration: Add IP Speaker". The InformaCast logo is in the top left, and the Singlewire Software logo is in the top right. A navigation menu includes "Support", "News", and "About Us". A sidebar on the left contains various administrative links such as "Send or Edit Messages", "Edit Recipient Groups", "Edit IP Speakers", "Listen at a Speaker", "Bell Scheduler", "Schedule Broadcasts", "Reporting", "Edit Configuration", "Manage License Key", "Security Administration", "Logged In as Temporary Administrator", "Change Password", "Log Out", "Help", "Install Guide", and "QuickPage Assistant". The main content area contains a form with the following fields and values:

- IP Speaker Name: (required)
- Speaker Description:
- Dial Code: (numeric shortcut for optional phone interface)
- MAC Address: (required, 12 hex digits)
- Volume:

At the bottom of the form are two buttons: "Cancel" and "Add". A red arrow originates from the "Add" button and points to the word "Add" located below the screenshot.



Your unit is now registered to the InformaCast server. You now can configure this device as part of the InformaCast system setup as required.

Appendix A: Mounting the Amplifier

A.1 Mount the Paging Amplifier

Before you mount the enclosure, make sure that you have received all of the parts for each enclosure. Refer to [Table A-12](#).

Table A-12. Wall Mounting Components (Part of the Accessory Kit)

Quantity	Part Name	Illustration
3	#6 Plastic Ribbed Anchors	
3	#6 Sheet Metal Screws	

Note The Paging Amplifier was designed for indoor use. Mounting it on the external part of a building will require additional hardware for weatherproofing, cabling access, and lightning suppression. Consult a certified electrician for details.

Note For mounting, use the three #6 **SHEET METAL SCREWS** to secure the enclosure.

Appendix B: Setting up a TFTP Server

B.1 Set up a TFTP Server

Upgrading the VoIP V2 Loudspeaker Amplifier firmware requires a TFTP server on which you access the Web interface where you can upload the firmware files.

B.1.1 In a LINUX Environment

To set up a TFTP server on LINUX:

1. Create a directory dedicated to the TFTP server, and move the files to be uploaded to that directory.
2. Run the following command where `/tftpboot/` is the path to the directory you created in [Step 1](#): the directory that contains the files to be uploaded. For example:

```
in.tftpd -l -s /tftpboot/your_directory_name
```

B.1.2 In a Windows Environment

You can find several options online for setting up a Windows TFTP server. This example explains how to use the Solarwinds freeware TFTP server, which you can download at:

<http://www.cyberdata.net/support/voip/solarwinds.html>

To set up a TFTP server on Windows:

1. Install and start the software.
2. Select **File/Configure/Security** tab/**Transmit Only**.
3. Make a note of the default directory name, and then move the firmware files to be uploaded to that directory.

Appendix C: Troubleshooting/Technical Support

C.1 Frequently Asked Questions (FAQ)

To see a list of frequently asked questions for your product, do the following:

1. Go to the following URL:

<http://www.cyberdata.net/products/voip/digitalanalog/singlewirepagingampv2/faqs.html>

2. Go to the support page for your product, and click on the **FAQs** tab.

C.2 Documentation

The documentation for this product is released in an English language version only. You can download PDF copies of CyberData product documentation by doing the following:

1. Go to the following URL:

<http://www.cyberdata.net/products/voip/digitalanalog/singlewirepagingampv2/docs.html>

2. Go to the support page for your product, and click on the **Documentation** tab.

C.3 Contact Information

Contact	<p>CyberData Corporation 3 Justin Court Monterey, CA 93940 USA www.CyberData.net Phone: 800-CYBERDATA (800-292-3732) Fax: 831-373-4193</p>
Sales	<p>Sales 831-373-2601 Extension 334</p>
Technical Support	<p>The fastest way to get technical support for your VoIP product is to submit a VoIP Technical Support form at the following website:</p> <p>http://www.cyberdata.net/support/contactsupportvoip.html</p> <p>Phone: (831) 373-2601, Ext. 333 Email: support@cyberdata.net</p>
Returned Materials Authorization	<p>To return the product, contact the Returned Materials Authorization (RMA) department:</p> <p>Phone: 831-373-2601, Extension 136 Email: RMA@CyberData.net</p> <p>When returning a product to CyberData, an approved CyberData RMA number must be printed on the outside of the original shipping package. No product will be accepted for return without an approved RMA number. Send the product, in its original package, to the following address:</p> <p>CyberData Corporation 3 Justin Court Monterey, CA 93940 Attention: RMA "your RMA number"</p>
RMA Status Form	<p>If you need to inquire about the repair status of your product(s), please use the CyberData RMA Status form at the following web address:</p> <p>http://www.cyberdata.net/support/rmastatus.html</p>

C.4 Warranty

CyberData warrants its product against defects in material or workmanship for a period of two years from the date of purchase. Should the product fail within the warranty period, CyberData will repair or replace the product free of charge. This warranty includes all parts and labor.

Should the product fail out-of-warranty, a flat rate repair charge of one half of the purchase price of the product will be assessed. Repairs that are in warranty but are damaged by improper modifications or abuse, will be charged at the out-of-warranty rate. Products shipped to CyberData, both in and out-of-warranty, are shipped at the expense of the customer. Shipping charges for repaired products shipped back to the customer by CyberData, will be paid by CyberData.

CyberData shall not under any circumstances be liable to any person for any special, incidental, indirect or consequential damages, including without limitation, damages resulting from use or malfunction of the products, loss of profits or revenues or costs of replacement goods, even if CyberData is informed in advance of the possibility of such damages.

C.4.1 Warranty & RMA Returns within the United States

If service is required, you must contact CyberData Technical Support prior to returning any products to CyberData. Our Technical Support staff will determine if your product should be returned to us for further inspection. If Technical Support determines that your product needs to be returned to CyberData, an RMA number will be issued to you at this point.

Your issued RMA number must be printed on the outside of the shipping box. No product will be accepted for return without an approved RMA number. The product in its original package should be sent to the following address:

CyberData Corporation
3 Justin Court.
Monterey, CA 93940
Attn: RMA "xxxxxx"

C.4.2 Warranty & RMA Returns Outside of the United States

If you purchased your equipment through an authorized international distributor or reseller, please contact them directly for product repairs.

C.4.3 Spare in the Air Policy

CyberData now offers a *Spare in the Air* no wait policy for warranty returns within the United States and Canada. More information about the *Spare in the Air* policy is available at the following web address:

<http://www.cyberdata.net/support/warranty/spareintheair.html>

C.4.4 Return and Restocking Policy

For our authorized distributors and resellers, please refer to your CyberData Service Agreement for information on our return guidelines and procedures.

For End Users, please contact the company that you purchased your equipment from for their return policy.

C.4.5 Warranty and RMA Returns Page

The most recent warranty and RMA information is available at the CyberData Warranty and RMA Returns Page at the following web address:

<http://www.cyberdata.net/support/warranty/index.html>

Index

Symbols

#6 sheet metal screws 30

Numerics

1 speaker configuration 8, 9
 16 gauge wire 8, 9
 2 speaker configuration 9
 802.3af compliance switch 8
 802.3af mode 8, 9
 802.3af power injector (low power mode) 8
 802.3at compliance switch 9
 802.3at mode 9
 802.3at power injector (high power mode) 9

A

accessory kit 5
 activity LED 13
 address, configuration login 17
 amplified outputs 8, 9
 high power mode 9
 how to use and connect 8
 low power mode 8
 announcing an IP address 14
 audio encodings 3

C

configurable parameters 19
 configuration
 default IP settings 16
 using Web interface 16
 configuration home page 18
 configuration page
 configurable parameters 19
 connecting the amplified outputs 8
 contact information 33
 contact information for CyberData 33
 CyberData contact information 33
 CyberData support limited to IP endpoint
 functionality 24

D

default
 gateway 6, 16
 IP address 6, 16
 subnet mask 6, 16
 username and password 6, 16
 web login username and password 18
 default gateway 6, 16
 default IP settings 16
 default login address 17
 DHCP Client 3
 discovery utility program 17

E

enclosure, mounting 30

F

factory defaults 7, 14
 firmware
 where to get the latest firmware 20
 firmware upgrade parameters 22
 firmware upgrades 31

H

hazard levels 5
 high power mode (amplified outputs) 9
 home page 18
 http web-based configuration 3

I

identifying the speaker (when using InformaCast 4.0) 24
 identifying your product 1
 illustration of amplifier mounting process 30
 InformaCast
 Add IP Speaker Page 29
 IP Speaker Configuration page 25
 Test IP Speaker Page 27
 testing and identifying a Singlewire-enabled ceiling
 speaker 24

- Informacast linking to the wrong port and path 27
- InformaCast needs to be 4.0 or higher 1
- installation 2
- IP address 6, 16, 22
- IP addressing
 - default
 - IP addressing setting 6, 16

L

- LEDs 13
- link LED 13
- Linux, setting up a TFTP server on 31
- log in address 17
- loudspeaker, cabling/wiring 12
- loudspeaker, type 12
- low power mode (amplified outputs) 8

M

- maximum distance between speakers 9
- maximum wire length for single speaker configuration 8
- maximum wire length for two speaker configuration 9
- mounting an amplifier 30

N

- navigation (web page) 17
- navigation table 17
- network link activity, verifying 13

O

- one speaker configuration 8, 9
- operating temperature 4
- optional two speaker configuration 9

P

- packet time 3
- parts list 5
- password
 - login 18
 - restoring the default 6, 16
- power LED 13
- power, connecting to paging amplifier 8
- product

- configuring 16
 - mounting 30
 - parts list 5
- product features 3
- product overview
 - product features 3
 - product specifications 4
 - supported protocols 3
 - typical system installation 2
- product specifications 4
- protocols supported 3

R

- reboot 22, 23
- reset test function management switch 14
- resetting the IP address to the default 30
- restoring the factory defaults 7, 14
- return and restocking policy 35
- RMA returned materials authorization 33
- RMA status 33
- RTFM switch 7, 14
- RTP/AVP 3

S

- safety instructions 4
- sales 33
- service 33
- setting up a TFTP server 31
- Singlewire Informacast Server Web Interface 24
- Spare in the Air Policy 34
- speaker configuration 8, 9
- speaker configuration for two speakers 9
- standard 1 speaker configuration 8, 9
- status LED 13
- subnet mask 6, 16
- supported protocols 3

T

- tech support 33
- technical support, contact information 33
- testing the speaker (when using InformaCast 4.0) 24
- TFTP server 3, 31
- two speaker configuration 9

U

- username
 - default for web configuration access 18
 - restoring the default 6, 16
- using the amplified outputs 8

V

- verifying
 - network link and activity 13
 - power on 13
- volume 15
- volume dial 15

W

- warranty 34
- warranty & RMA returns outside of the United States 34
- warranty & RMA returns within the United States 34
- warranty and RMA returns page 35
- warranty policy at CyberData 34
- web access password 6, 16
- web access username 6, 16
- web configuration log in address 17
- web page
 - navigation 17
- web page navigation 17
- web-based paging amplifier configuration 16
- Windows, setting up a TFTP server on 31
- wire gauge 8, 9
- wire length for single speaker configuration 8
- wire length going to wire nuts for two speaker configuration 9
- wire nuts to connect wire 9