

SIP Strobe

Operations Guide

Part #011087

Document Part #930805A
for Firmware Version 10.0.1

CyberData Corporation
3 Justin Court
Monterey, CA 93940
(831) 373-2601

SIP Strobe Operations Guide 930805A
Part # 011087

COPYRIGHT NOTICE:

© 2013, CyberData Corporation, ALL RIGHTS RESERVED.

This manual and related materials are the copyrighted property of CyberData Corporation. No part of this manual or related materials may be reproduced or transmitted, in any form or by any means (except for internal use by licensed customers), without prior express written permission of CyberData Corporation. This manual, and the products, software, firmware, and/or hardware described in this manual are the property of CyberData Corporation, provided under the terms of an agreement between CyberData Corporation and recipient of this manual, and their use is subject to that agreement and its terms.

DISCLAIMER: Except as expressly and specifically stated in a written agreement executed by CyberData Corporation, CyberData Corporation makes no representation or warranty, express or implied, including any warranty or merchantability or fitness for any purpose, with respect to this manual or the products, software, firmware, and/or hardware described herein, and CyberData Corporation assumes no liability for damages or claims resulting from any use of this manual or such products, software, firmware, and/or hardware. CyberData Corporation reserves the right to make changes, without notice, to this manual and to any such product, software, firmware, and/or hardware.

OPEN SOURCE STATEMENT: Certain software components included in CyberData products are subject to the GNU General Public License (GPL) and Lesser GNU General Public License (LGPL) "open source" or "free software" licenses. Some of this Open Source Software may be owned by third parties. Open Source Software is not subject to the terms and conditions of the CyberData COPYRIGHT NOTICE or software licenses. Your right to copy, modify, and distribute any Open Source Software is determined by the terms of the GPL, LGPL, or third party, according to who licenses that software.

Software or firmware developed by CyberData that is unrelated to Open Source Software is copyrighted by CyberData, subject to the terms of CyberData licenses, and may not be copied, modified, reverse-engineered, or otherwise altered without explicit written permission from CyberData Corporation.

TRADEMARK NOTICE: CyberData Corporation and the CyberData Corporation logos are trademarks of CyberData Corporation. Other product names, trademarks, and service marks may be the trademarks or registered trademarks of their respective owners.



Technical Support

The fastest way to get technical support for your VoIP product is to submit a VoIP Technical Support form at the following website:
<http://www.cyberdata.net/support/contactsupportvoip.html>

Phone: (831) 373-2601, Ext. 333



Email: support@cyberdata.net

Fax: (831) 373-4193



Company and product information is at www.cyberdata.net.

Important Safety Instructions

1. Read these instructions.
2. Keep these instructions.
3. Heed all warnings.
4. Follow all instructions.
5. Do not use this apparatus near water.
6. Clean only with dry cloth.
7. Do not block any ventilation openings. Install in accordance with the manufacturer's instructions.
8. Do not install near any heat sources such as radiators, heat registers, stoves, or other apparatus (including amplifiers) that produce heat.
9. Do not defeat the safety purpose of the polarized or grounding-type plug. A polarized plug has two blades with one wider than the other. A grounding type plug has two blades and a third grounding prong. The wide blade or the third prong are provided for your safety. If the provided plug does not fit into your outlet, consult an electrician for replacement of the obsolete outlet.
10. Protect the power cord from being walked on or pinched particularly at plugs, convenience receptacles, and the point where they exit from the apparatus.
11. Only use attachments/accessories specified by the manufacturer.
12. Refer all servicing to qualified service personnel. Servicing is required when the apparatus has been damaged in any way, such as power-supply cord or plug is damaged, liquid has been spilled or objects have fallen into the apparatus, the apparatus has been exposed to rain or moisture, does not operate normally, or has been dropped.
13. Prior to installation, consult local building and electrical code requirements.
- 14. WARNING: The SIP Strobe enclosure is not rated for any AC voltages!**

 <p>GENERAL ALERT</p>	<p>Warning</p> <p><i>Electrical Hazard:</i> This product should be installed by a licensed electrician according to all local electrical and building codes.</p>
 <p>GENERAL ALERT</p>	<p>Warning</p> <p><i>Electrical Hazard:</i> To prevent injury, this apparatus must be securely attached to the floor/wall in accordance with the installation instructions.</p>

Pictorial Alert Icons

	<p>General Alert</p> <p>This pictorial alert indicates a potentially hazardous situation. This alert will be followed by a hazard level heading and more specific information about the hazard.</p>
	<p>Ground</p> <p>This pictorial alert indicates the Earth grounding connection point.</p>

Hazard Levels

Danger: Indicates an imminently hazardous situation which, if not avoided, will result in death or serious injury. This is limited to the most extreme situations.

Warning: Indicates a potentially hazardous situation which, if not avoided, could result in death or serious injury.

Caution: Indicates a potentially hazardous situation which, if not avoided, could result in minor or moderate injury. It may also alert users against unsafe practices.

Notice: Indicates a statement of company policy (that is, a safety policy or protection of property).

The safety guidelines for the equipment in this manual do not purport to address all the safety issues of the equipment. It is the responsibility of the user to establish appropriate safety, ergonomic, and health practices and determine the applicability of regulatory limitations prior to use. Potential safety hazards are identified in this manual through the use of words Danger, Warning, and Caution, the specific hazard type, and pictorial alert icons.

Abbreviations and Terms

Abbreviation or Term	Definition
A-law	A standard companding algorithm, used in European digital communications systems to optimize, i.e., modify, the dynamic range of an analog signal for digitizing.
AVP	Audio Video Profile
Cat 5	TIA/EIA-568-B Category 5
DHCP	Dynamic Host Configuration Protocol
LAN	Local Area Network
LED	Light Emitting Diode
Mbps	Megabits per Second.
NTP	Network Time Protocol
PBX	Private Branch Exchange
PoE	Power over Ethernet (as per IEEE 802.3af standard)
RTFM	Reset Test Function Management
SIP	Session Initiated Protocol
u-law	A companding algorithm, primarily used in the digital telecommunication
UC	Unified Communications
VoIP	Voice over Internet Protocol

Revision Information

Revision 930805A, which corresponds to firmware version 10.0.1, was released on November 25, 2013.

Browsers Supported

The following browsers have been tested against firmware version 10.0.1:

- Internet Explorer (version: 10)
- Firefox (also called Mozilla Firefox) (version: 23.0.1 and 25.0)
- Chrome (version: 29.0.1547.66 m)
- Safari (version: 5.1.7)

Contents

Chapter 1 Product Overview	1
1.1 How to Identify This Product	1
1.2 Typical System Installation	2
1.3 Product Features	3
1.4 Supported Protocols	3
1.5 Supported SIP Servers	3
1.6 Product Specifications	4
1.7 Dimensions	4
Chapter 2 Installing the SIP Strobe	5
2.1 Parts List	5
2.1 SIP Strobe Setup	6
2.1.1 SIP Strobe Connections	6
2.1.2 Connecting the SIP Strobe to the Auxiliary Relay	7
2.1.3 Identifying the SIP Strobe Connectors and Jumpers	9
2.1.4 Network Connectivity	12
2.1.5 Restore the Factory Default Settings	13
2.2.1 SIP Strobe Web Page Navigation	15
2.2.2 Log in to the Configuration Home Page	16
2.2.3 Configure the Device	19
2.2.4 Configure the Network Parameters	21
2.2.5 Configure the SIP Parameters	23
2.2.6 Configure the Night Ringer Parameters	26
2.2.7 Configure the Sensor Configuration Parameters	28
2.2.8 Configure the Multicast Parameters	30
2.2.9 Configure the Event Parameters	32
2.2.10 Configure the Autoprovisioning Parameters	37
2.3.1 Reboot the SIP Strobe	47
2.4.1 Command Interface Post Commands	48
Appendix A Mounting the SIP Strobe	49
A.1 Mount the SIP Strobe	49
Appendix B Troubleshooting/Technical Support	53
B.1 Frequently Asked Questions (FAQ)	53
B.2 Documentation	53
B.3 Contact Information	54
B.4 Warranty	55
B.4.1 Warranty & RMA Returns within the United States	55
B.4.2 Warranty & RMA Returns Outside of the United States	55
B.4.3 Spare in the Air Policy	56
B.4.4 Return and Restocking Policy	56
B.4.5 Warranty and RMA Returns Page	56
Index	57

1 Product Overview

1.1 How to Identify This Product

To identify the SIP Strobe, look for a model number label similar to the one shown in [Figure 1-1](#). Confirm the following:

- The model number on the label should be **011087**.
- The serial number on the label should begin with **0871**.

Figure 1-1. Model Number Label

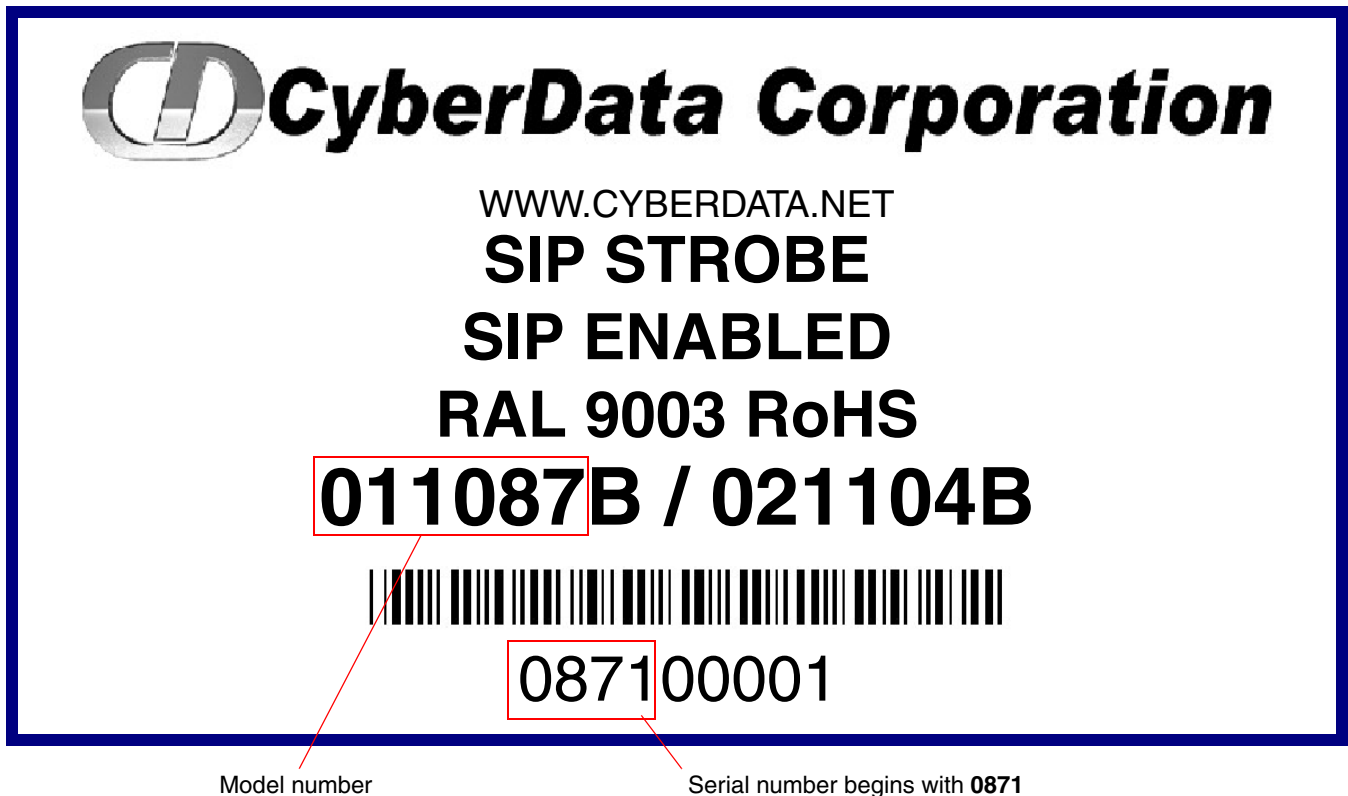





1.2 Typical System Installation

The Session Initiation Protocol (SIP) SIP Strobe is a SIP endpoint designed to provide VoIP phone connectivity in a tamper proof and secure package.

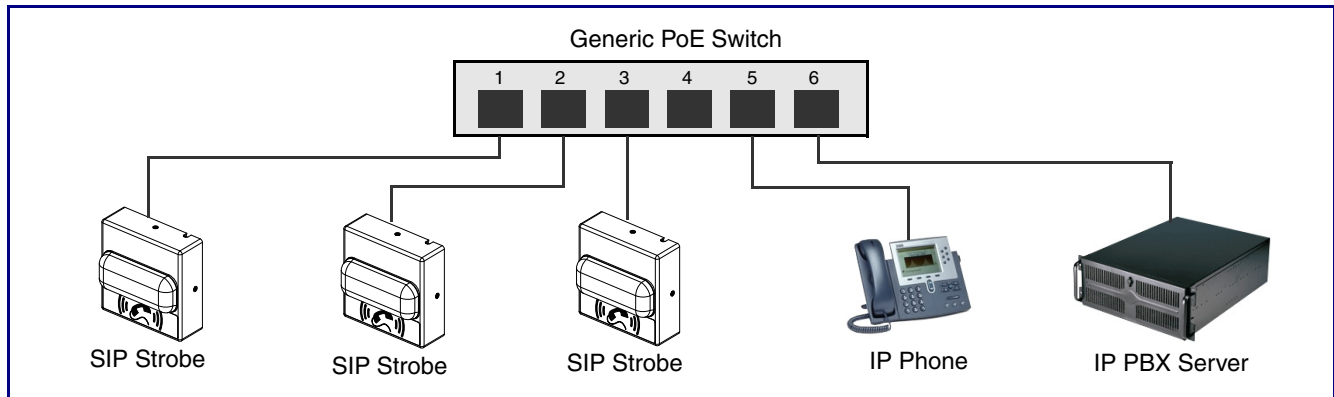
Figure 1-2 illustrate how the SIP Strobes can be installed as part of a VoIP phone system.

Figure 1-2. Typical Installation



 GENERAL ALERT	<p>Warning <i>Electrical Hazard:</i> The SIP Strobe enclosure is not rated for any AC voltages.</p>
 GENERAL ALERT	<p>Warning <i>Electrical Hazard:</i> This product should be installed by a licensed electrician according to all local electrical and building codes.</p>
 GENERAL ALERT	<p>Warning <i>Electrical Hazard:</i> To prevent injury, this apparatus must be securely attached to the floor/wall in accordance with the installation instructions.</p>

1.3 Product Features

- Meets ADA requirements for telephony signaling and notification
- Program or listen to up to 10 multicast addresses
- SIP activation
- Mailbox message waiting indication
- Multicast activation
- Cisco SRST support
- Event-controlled relay

Note: The relay contacts are dry and provided for a normally open and momentarily closed configuration. Neither the alternate power input nor PoE power can be used to drive a door strike.

- Tamper sensor
- Web-based setup
- PoE-powered

1.4 Supported Protocols

The SIP Strobe supports:

- SIP
- HTTP Web-based configuration

Provides an intuitive user interface for easy system configuration and verification of SIP Strobe operations.

- DHCP Client

Dynamically assigns IP addresses in addition to the option to use static addressing.

- RTP
- RTP/AVP - Audio Video Profile
- Audio Encodings

PCMU (G.711 mu-law)

PCMA (G.711 A-law)

Packet Time 20 ms

1.5 Supported SIP Servers

Go to the following link to find the SIP Strobe product page which will have information on how to configure the SIP Strobe for various supported SIP servers:

<http://www.cyberdata.net/support/server/index.html>

1.6 Product Specifications

Category	Specification
Network Rate	10/100 Mbps
Power Requirement	802.3af compliant or +12 to 24 VDC at 1000 mA (500 mA minimum)
Protocol	SIP
Part Number	011087
Dimensions	4.5" x 4.5" x 1.5"
Weight	1.6 lbs./shipping weight of 2.2 lbs. (0.7 kg/shipping weight of 1.0kg)
Auxiliary Relay	1A at 30 VDC

1.7 Dimensions

Figure 1-3. Dimensions—Size of Unit with Case

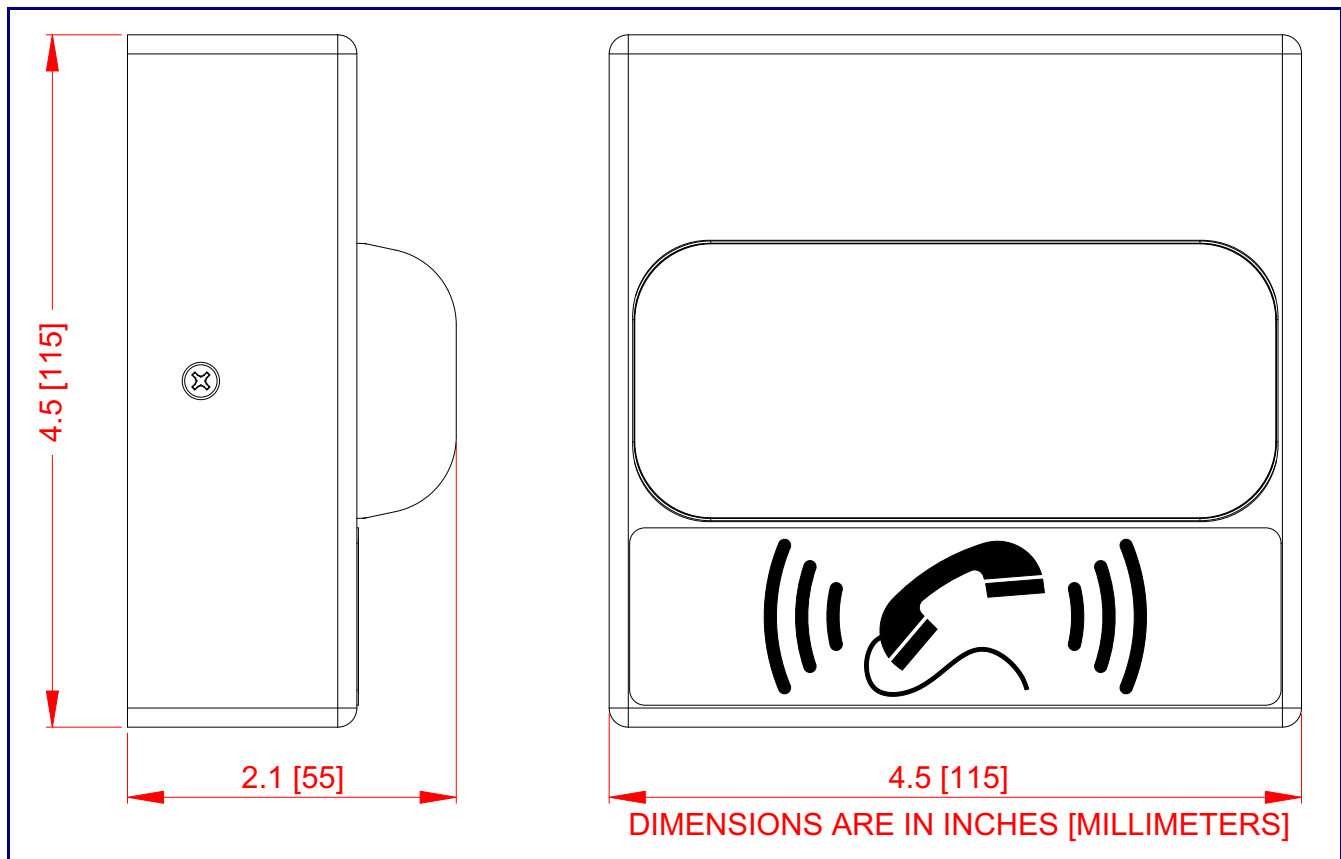



2 Installing the SIP Strobe

2.1 Parts List

Table 2-1 illustrates the SIP Strobe parts.

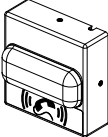
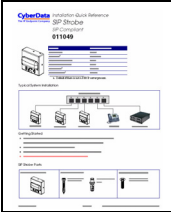
Table 2-1. Parts List

Quantity	Part Name	Illustration
1	SIP Strobe Assembly	
1	Installation Quick Reference Guide	
1	SIP Strobe Mounting Accessory Kit	

2.1 SIP Strobe Setup

2.1.1 SIP Strobe Connections

Figure 2-4 shows the pin connections on the J3 (terminal block). This terminal block can accept 16 AWG gauge wire.

Note As an alternative to using PoE power, you can supply +12 to 24 VDC at 1000 mA (500 mA minimum) into the terminal block.





 <small>GENERAL ALERT</small>	<p>Caution</p> <p>Equipment Hazard: Contacts 1 and 2 on the J3 terminal block are only for powering the device from a non-PoE +12VDC power source as an alternative to Network PoE power. Use of these contacts for any other purpose will damage the device and void the product warranty.</p>
---	---

Figure 2-4. SIP Strobe Connections

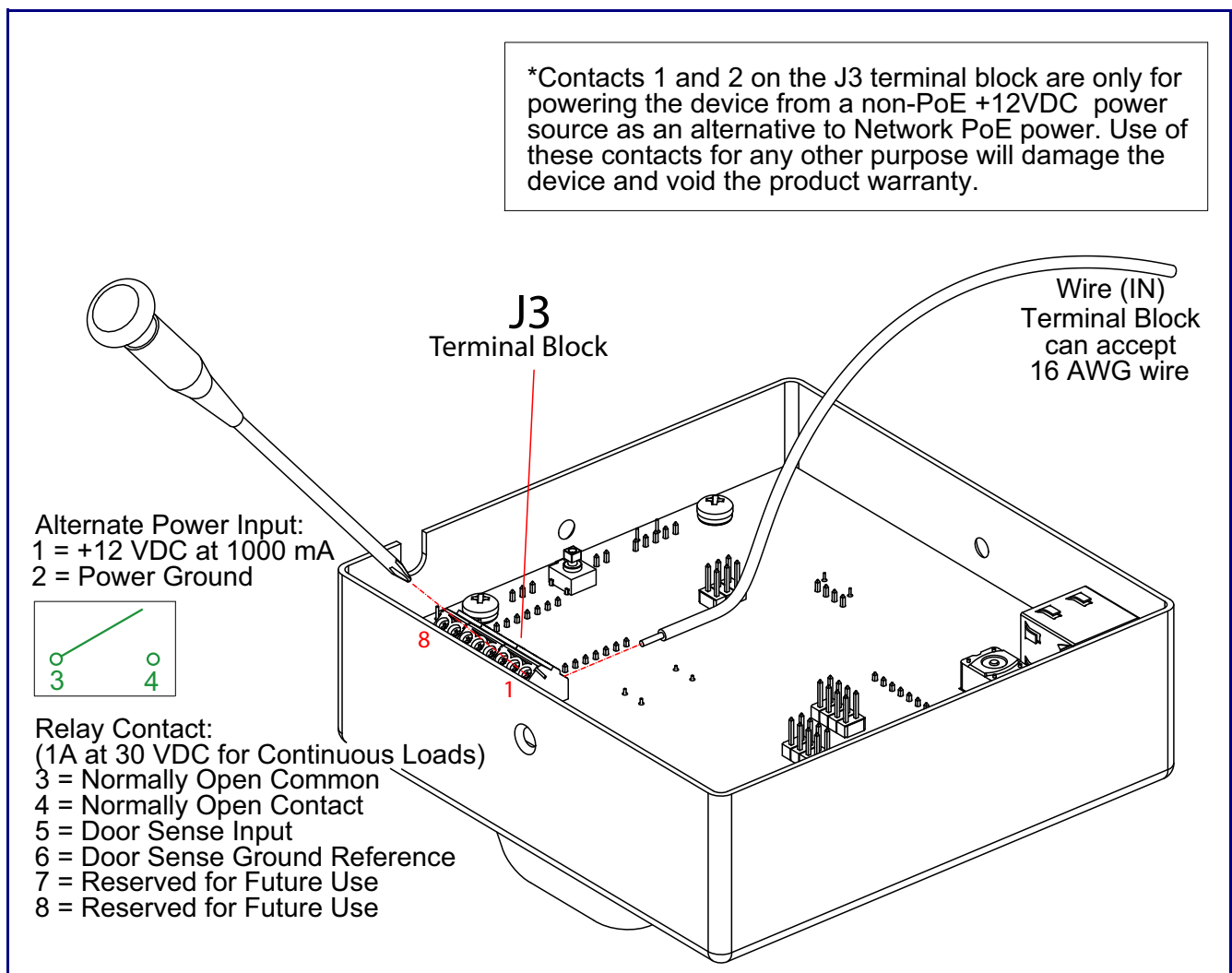

2.1.2 Connecting the SIP Strobe to the Auxiliary Relay

	<p>Warning <i>Electrical Hazard:</i> The SIP Strobe enclosure is not rated for any AC voltages.</p>
	<p>Warning <i>Electrical Hazard:</i> This product should be installed by a licensed electrician according to all local electrical and building codes.</p>
	<p>Warning <i>Electrical Hazard:</i> To prevent injury, this apparatus must be securely attached to the floor/wall in accordance with the installation instructions.</p>
	<p>Warning <i>Electrical Hazard:</i> The relay contacts are dry and provided for a normally open and momentarily closed configuration. Neither the alternate power input nor PoE power can be used to drive a door strike.</p>

The device incorporates an on-board relay which enables users to control an external relay for activating an auxiliary device such as an electric door strike (see [Figure 2-5, "Auxiliary Relay Wiring Diagram"](#)).

The relay contacts are limited to 1A at 30 VDC. The relay activation time is selectable through the web interface and is controlled by DTMF tones generated from the phone being called. The DTMF tones are selectable from the web interface as well.

Figure 2-5. Auxiliary Relay Wiring Diagram

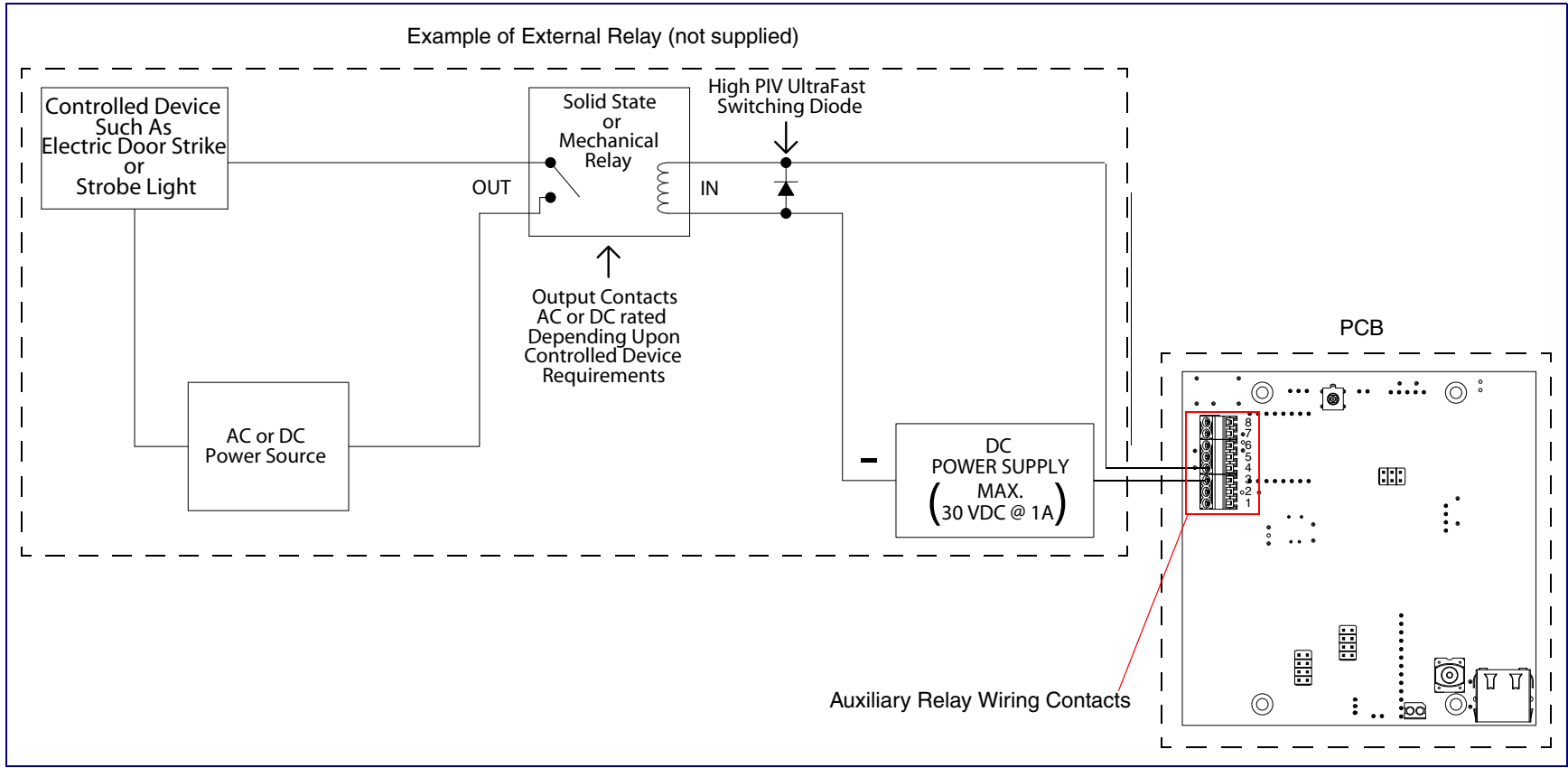

2.1.3 Identifying the SIP Strobe Connectors and Jumpers

See the following figures and tables to identify the SIP Strobe connector locations and functions.

Figure 2-6. Connector Locations for the 021084 Board

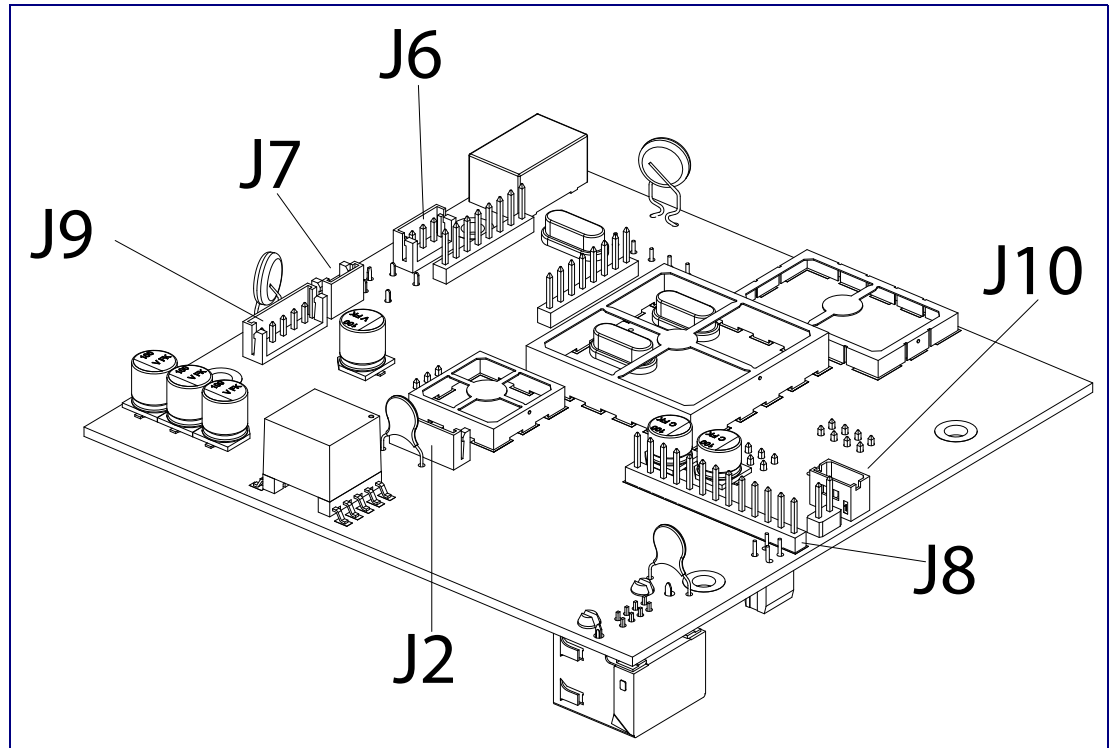

Table 2-2. Connector Functions

Connector	Function
J2	Call Button Interface — Not Used
J6	Microphone Interface — Not Used
J7	Speaker Interface — Not Used
J9	Strobe Power Interface
J8	Keypad Interface -- Not Used
J10	Proximity Sensor Interface — Not Used

Figure 2-7. Connector Locations for the 021084 Board

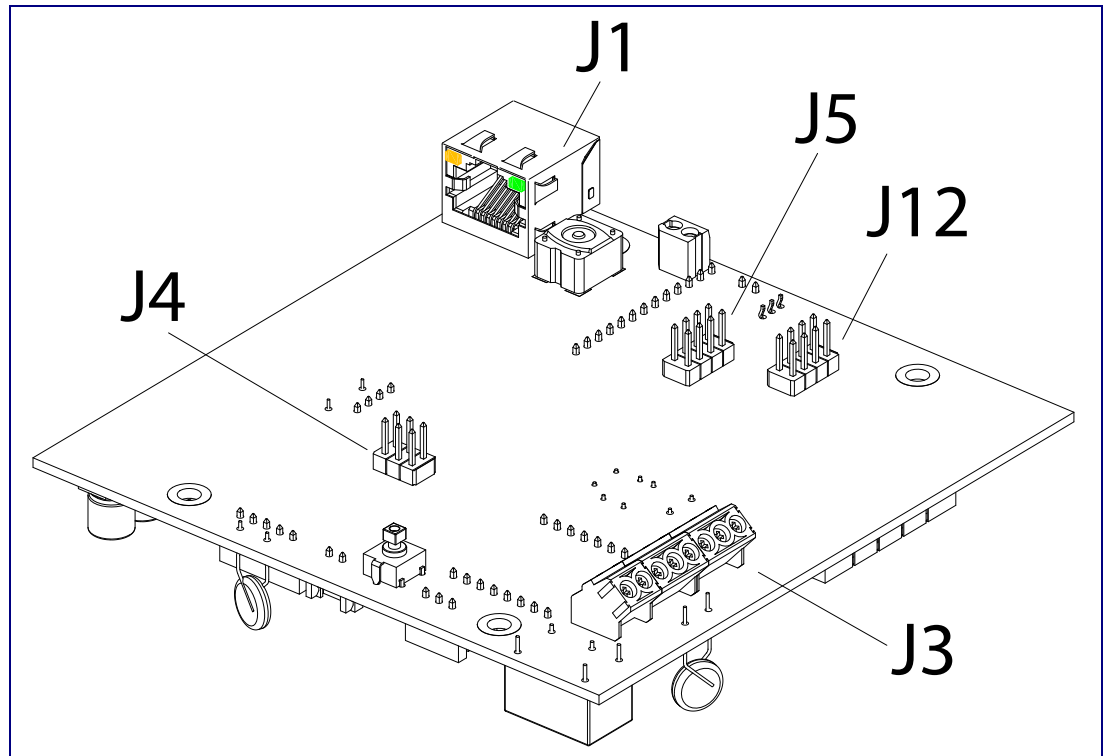

Table 2-3. Connector Functions

Connector	Function
J1	Ethernet Connector
J3	User Terminal Block Interface
J4	Reserved (Factory Use Only)
J5	Reserved (Factory Use Only)
J12	Reserved (Factory Use Only)

Figure 2-8. Connector Locations for the 021054 Board

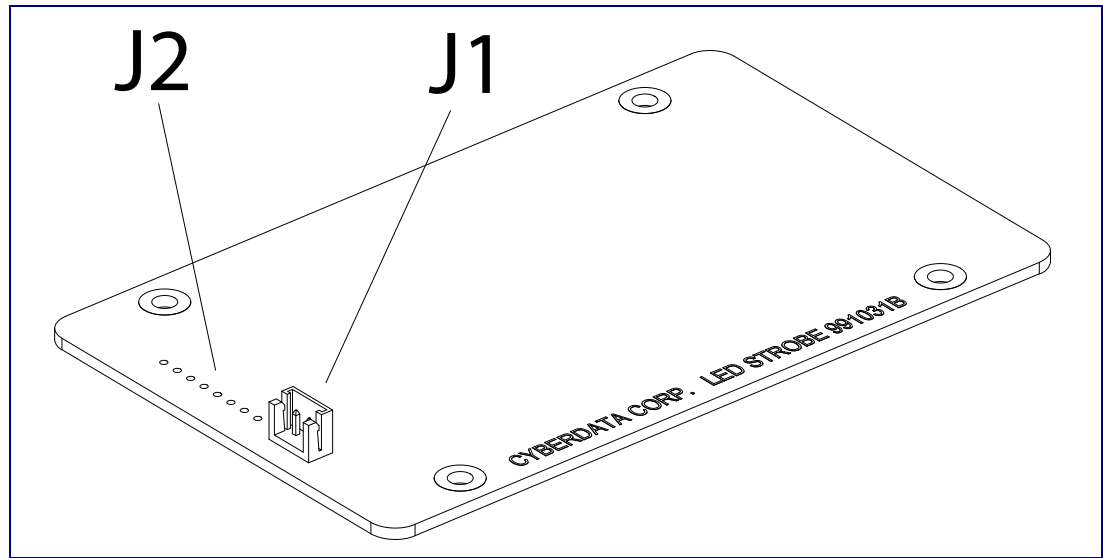

Table 2-4. Connector Functions

Connector	Function
J1	Ethernet Connector
J2	Call Button Interface — Not Used

2.1.3.1 Connecting the 021054 and 021084 Boards with the 031142 Cable Assembly

Use [Figure 2-9](#) to see how the 021054 and 021084 boards are connected with the 031142 cable assembly.

Figure 2-9. 021054 and 021084 Boards Connected with the 031142 Cable Assembly

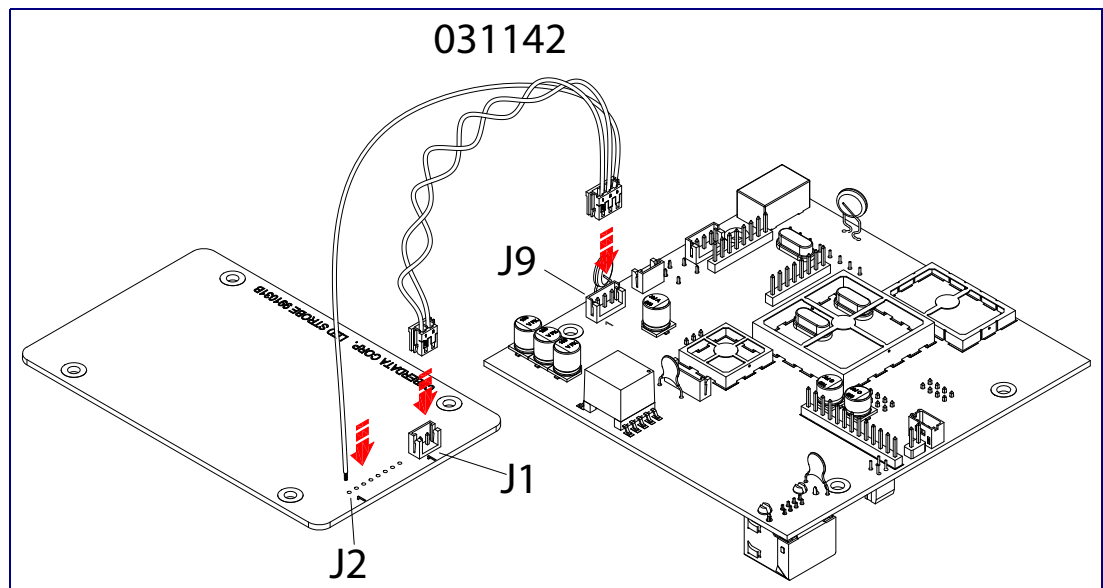

2.1.4 Network Connectivity

When you plug in the Ethernet cable (Figure 2-10) or power supply:

- The square, **GREEN Link** LED (Figure 2-10) above the Ethernet port indicates that the network connection has been established.
- The square, **YELLOW Activity** LED (Figure 2-10) blinks when there is network activity.

Figure 2-10. Network LEDs

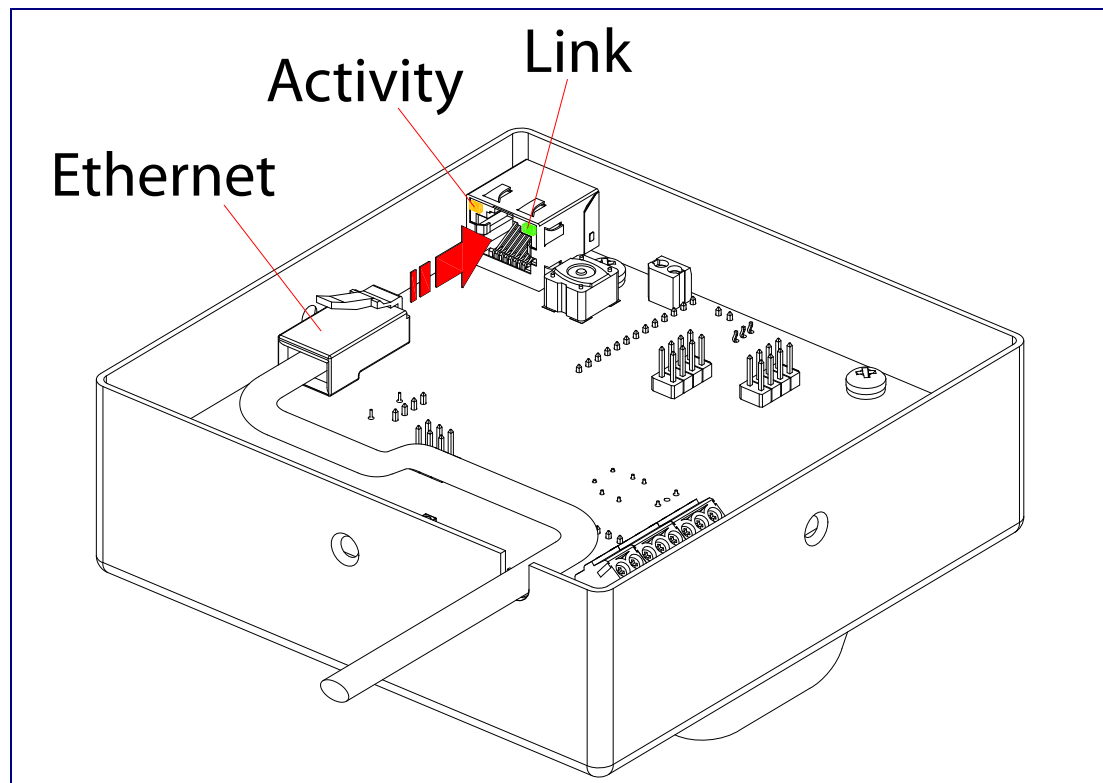

2.1.5 Restore the Factory Default Settings

2.1.5.1 RTFM Switch

When the SIP Strobe is operational and linked to the network, use the Reset Test Function Management (RTFM) switch (Figure 2-11) to set the factory default settings.

Note Each SIP Strobe is delivered with factory set default values.

Note The SIP Strobe will use DHCP to obtain the new IP address (DHCP-assigned address or default to 10.10.10.10 if a DHCP server is not present).

Figure 2-11. RTFM Switch

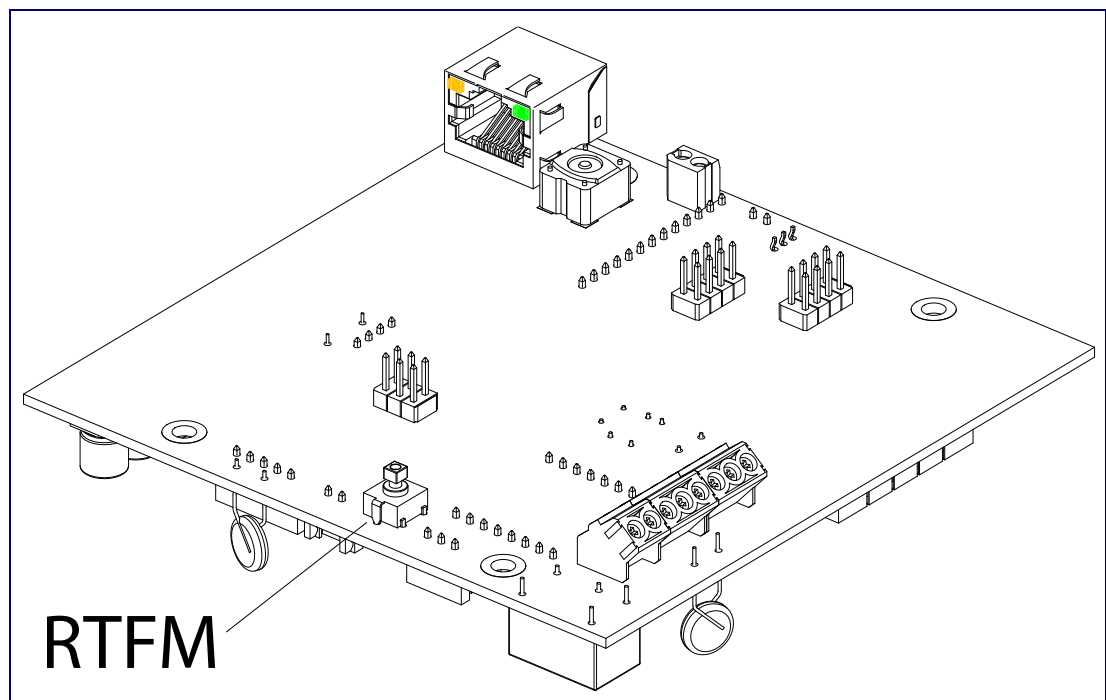

To set the factory default settings:

1. Press and hold the RTFM switch for seven seconds, and then release the RTFM switch.

2.2 Configure the SIP Strobe Parameters

To configure the SIP Strobe online, use a standard web browser.

Configure each SIP Strobe and verify its operation *before* you mount it. When you are ready to mount an SIP Strobe, refer to [Appendix A, "Mounting the SIP Strobe"](#) for instructions.

All SIP Strobes are initially configured with the following default IP settings:

When configuring more than one SIP Strobe, attach the SIP Strobes to the network and configure one at a time to avoid IP address conflicts.

Table 2-5. Factory Default Settings











Parameter	Factory Default Setting
IP Addressing	DHCP
IP Address ^a	10.10.10.10
Web Access Username	admin
Web Access Password	admin
Subnet Mask ^a	255.0.0.0
Default Gateway ^a	10.0.0.1

a. Default if there is not a DHCP server present.

2.2.1 SIP Strobe Web Page Navigation

Table 2-6 shows the navigation buttons that you will see on every SIP Strobe web page.

Table 2-6. Web Page Navigation

Web Page Item	Description
	Link to the Home page.
	Link to the Device Configuration page.
	Link to the Networking page.
	Link to go to the SIP Configuration page.
	Link to go to the Nightringer page.
	Link to the Sensor Configuration page.
	Link to the Multicast Configuration page.
	Link to the Event Configuration page.
	Link to the Autoprovisioning Configuration page.
	Link to the Update Firmware page.

2.2.2 Log in to the Configuration Home Page

1. Open your browser to the SIP Strobe IP address.

Note If the network does not have access to a DHCP server, the device will default to an IP address of 10.10.10.10.

Note Make sure that the PC is on the same IP network as the SIP Strobe.

Note You may also download CyberData's VoIP Discovery Utility program which allows you to easily find and configure the default web address of the CyberData VoIP products.

CyberData's VoIP Discovery Utility program is available at the following website address:

http://www.cyberdata.net/support/voip/discovery_utility.html

Note The SIP Strobe ships in DHCP mode. To get to the **Home** page, use the discovery utility to scan for the device on the network and open your browser from there.

2. When prompted, use the following default **Web Access Username** and **Web Access Password** to access the **Home Page** (Figure 2-12):

Web Access Username: **admin**

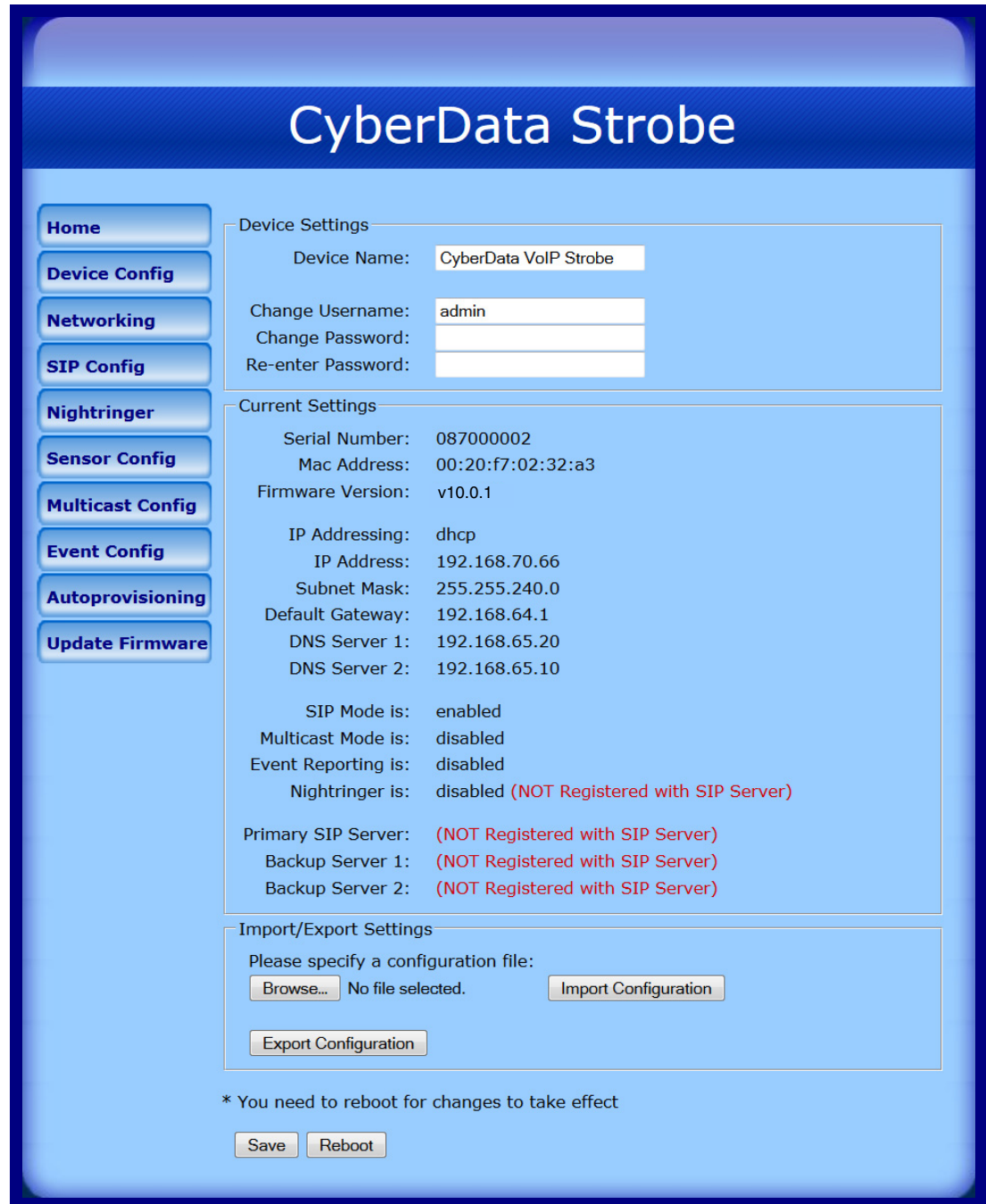

Web Access Password: **admin**

Figure 2-12. Home Page

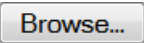
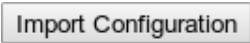
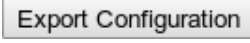

3. On the **Home Page**, review the setup details and navigation buttons described in [Table 2-7](#).

Table 2-7. Home Page Overview

Web Page Item	Description
Device Settings	
Device Name	Shows the device name.
Change Username	Type in this field to change the username.
Change Password	Type in this field to change the password.
Re-enter Password	Type the password again in this field to confirm the new password.
Current Settings	
Serial Number	Shows the device serial number.
Mac Address	Shows the device Mac address.
Firmware Version	Shows the current firmware version.
IP Addressing	Shows the current IP addressing setting (DHCP or static).
IP Address	Shows the current IP address.
Subnet Mask	Shows the current subnet mask address.
Default Gateway	Shows the current default gateway address.
DNS Server 1	Shows the current DNS Server 1 address.
DNS Server 2	Shows the current DNS Server 2 address.
SIP Mode is	Shows the current status of the SIP mode.
Multicast Mode is	Shows the current status of the Multicast mode.
Event Reporting is	Shows the current status of the Event Reporting mode.
Nightringer is	Shows the current status of the Nightringer mode.
Primary SIP Server	Shows the current status of the Primary SIP Server.
Backup Server 1	Shows the current status of Backup Server 1.
Backup Server 2	Shows the current status of Backup Server 2.
Import/Export Settings	
	Press the Browse button to select a configuration file to import.
	IPress the Import Configuration button to save a board configuration to the board. Note: The board will have to be reset before changes will take effect.
	Press the Export Configuration button to download the current board configuration.
	Click on the Save button to save your configuration settings. Note: You need to reboot for changes to take effect.
	Click on the Reboot button to reboot the system.

2.2.3 Configure the Device

1. Click the **Device Configuration** button to open the **Device Configuration** page. See [Figure 2-13](#).

Figure 2-13. Device Configuration Page

CyberData Strobe

Device Configuration

Home
Device Config
Networking
SIP Config
Nightringer
Sensor Config
Multicast Config
Event Config
Autoprovisioning
Update Firmware

Relay Settings

Activate Relay During Ring:

Activate Relay During Night Ring:

Miscellaneous Settings

Blink Strobe On Ring:

Blink Strobe On Message Waiting (MWI):

* You need to reboot for changes to take effect

Save Reboot
Test Relay Test Strobe

- On the **Device Configuration** page, you may enter values for the parameters indicated in [Table 2-8](#).

Table 2-8. Device Configuration Parameters

Web Page Item	Description
Relay Settings	
Activate Relay During Ring	When selected, the relay will be activated for as long as the call is active.
Activate Relay During Night Ring	Check this box to activate the relay for as long as a Night Ring tone is ringing.
Miscellaneous Settings	
Blink Strobe on Ring	When selected, the strobe light will blink during an incoming call.
Blink Strobe on Message Waiting (MWI)	When selected, the strobe light will blink if there is a message waiting.
<input type="button" value="Save"/>	Click the Save button to save your configuration settings. Note: You need to reboot for changes to take effect.
<input type="button" value="Reboot"/>	Click on the Reboot button to reboot the system.
<input type="button" value="Test Relay"/>	Click on the Test Relay button to do a relay test.
<input type="button" value="Test Strobe"/>	Click on the Test Strobe button to do a strobe test.

- After changing the parameters, click the **Save** button.

2.2.4 Configure the Network Parameters

1. Click the **Networking** button to open the **Network Configuration** page (Figure 2-14).

Figure 2-14. Network Configuration Page

CyberData Strobe

Home **Device Config** **Networking** **SIP Config** **Nightringer** **Sensor Config** **Multicast Config** **Event Config** **Autoprovisioning** **Update Firmware**

Network Configuration

Stored Network Settings

IP Addressing: Static DHCP

IP Address: 10.10.10.10

Subnet Mask: 255.0.0.0

Default Gateway: 10.0.0.1

DNS Server 1: 10.0.0.1

DNS Server 2: 10.0.0.1

Hostname: SipDevice0232a3

VLAN ID (0-4095): 0

VLAN Priority (0-7): 0

DHCP Timeout

DHCP Timeout in seconds*: 60



* A value of -1 will retry forever

* You need to reboot for changes to take effect

Save Reboot

2. On the **Network Configuration** page, enter values for the parameters indicated in [Table 2-9](#).

Table 2-9. Network Configuration Parameters

Web Page Item	Description
Stored Network Settings	
IP Addressing	Select either DHCP IP Addressing or Static IP Addressing by marking the appropriate radio button. If you select Static , configure the remaining parameters indicated in Table 2-9 . If you select DHCP , go to Step 3 .
IP Address	Enter the Static IP address.
Subnet Mask	Enter the Subnet Mask address.
Default Gateway	Enter the Default Gateway address.
DNS Server 1	Enter the DNS Server 1 address.
DNS Server 2	Enter the DNS Server 2 address.
Hostname	This is the hostname provided to the DHCP server. This can be used in conjunction with a DNS server to address the device by host name instead of by IP address. Check your DHCP server and DNS server documentation for more information.
VLAN ID (0-4095)	Enter the VLAN ID number. Note: The device supports 802.11Q VLAN tagging support. The switch port connected to the device will need to be in “trunking mode” for the VLAN tags to propagate.
VLAN Priority (0-7)	Enter the VLAN priority number.
DHCP Timeout	
DHCP Timeout in seconds	Enter the desired timeout duration (in seconds) that the device will wait for a response from the DHCP server before defaulting back to the stored static IP address. Note: A value of -1 will cause the device to retry indefinitely and a value of 0 will cause the device to reset to a default of 60 seconds.
	Click the Save button to save your configuration settings. Note: You need to reboot for changes to take effect.
	Click on the Reboot button to reboot the system.

3. After changing the parameters, click **Save Settings**. This updates the changed parameters and reboots the SIP Strobe if appropriate.
4. Connect the SIP Strobe to the target network.
5. From a system on the same network as the SIP Strobe, open a browser with the new IP address of the SIP Strobe.

2.2.5 Configure the SIP Parameters

1. Click **SIP Config** to open the **SIP Configuration** page (Figure 2-15).

Note For specific server configurations, go to the following website address:

<http://www.cyberdata.net/support/server/index.html>

Figure 2-15. SIP Configuration Page

CyberData Strobe

SIP Configuration

Enable SIP operation: (NOT Registered)

SIP Settings

Primary SIP Server [registration_status]: 10.0.0.253
 Primary SIP User ID: 199
 Primary SIP Auth ID: 199
 Primary SIP Auth Password: ●●●●●●

Backup SIP Server 1 (NOT Registered):
 Backup SIP User ID 1:
 Backup SIP Auth ID 1:
 Backup SIP Auth Password 1:

Backup SIP Server 2 (NOT Registered):
 Backup SIP User ID 2:
 Backup SIP Auth ID 2:
 Backup SIP Auth Password 2:

Use Cisco SRST:

Remote SIP Port: 5060
 Local SIP Port: 5060
 Outbound Proxy:
 Outbound Proxy Port: 0

Register with a SIP Server:
 Re-registration Interval (in seconds): 360
 NAT ping (check box if PBX is not local):
 Disable rport Discovery:

RTP Settings

RTP Port (even): 10500

* You need to reboot for changes to take effect



Save Reboot

2. On the **SIP Configuration** page, enter values for the parameters indicated in [Table 2-10](#).

Table 2-10. SIP Configuration Parameters

Web Page Item	Description
Enable SIP Operation	Enables or disables SIP operation.
SIP Settings	
Primary SIP Server [registration status]	Type the SIP server represented as either a numeric IP address in dotted decimal notation or the fully qualified host name (255 character limit [FQDN]).
Primary SIP User ID	Type the SIP User ID for the Primary SIP Server (up to 64 alphanumeric characters).
Primary SIP Auth ID	Type the SIP Authenticate ID for the Primary SIP Server (up to 64 alphanumeric characters).
Primary SIP Auth Password	Type the SIP Authenticate Password for the Primary SIP Server (up to 64 alphanumeric characters).
Backup SIP Server 1 Backup SIP Server 2	<ul style="list-style-type: none"> If all of the SIP Server and Backup SIP Server fields are populated, the device will attempt to stay registered with all three servers all of the time. You can leave the Backup SIP Server 1 and Backup SIP Server 2 fields blank if they are not needed. In the event of a registration failure on the Primary SIP Server, the device will use the next highest priority server for outbound calls (Backup SIP Server 1). If Backup SIP Server 1 fails, the device will use Backup SIP Server 2. If a higher priority SIP Server comes back online, the device will switch back to this server.
Backup SIP User ID 1 Backup SIP User ID 2	Type the SIP User ID for the Backup SIP Server (up to 64 alphanumeric characters).
Backup SIP Auth ID 1 Backup SIP Auth ID 2	Type the SIP Authenticate ID for the Backup SIP Server (up to 64 alphanumeric characters).
Backup SIP Auth Password 1 Backup SIP Auth Password 2	Type the SIP Authenticate Password for the Backup SIP Server (up to 64 alphanumeric characters).
Use Cisco SRST	When selected, the backup servers are handled according to Cisco SRST (Survivable Remote Site Telephony).
Remote SIP Port	Type the Remote SIP Port number (default 5060) (5 character limit [values from 1 to 65535]).
Local SIP Port	Type the Local SIP Port number (default 5060) (5 character limit [values from 2000 to 65535]).
Outbound Proxy	Type the Outbound Proxy as either a numeric IP address in dotted decimal notation or the fully qualified host name (255 character limit [FQDN]).
Outbound Proxy Port	Type the Outbound Proxy Port number (5 character limit [values from 1 to 65535]).
Register with a SIP Server	Check this box to enable SIP Registration.
Re-registration Interval (in seconds)	Type the SIP registration lease time (in seconds).

Table 2-10. SIP Configuration Parameters (continued)

Web Page Item	Description
NAT ping (check box if PBX is not local)	Check this box if the PBX server is remote and you are experiencing problems establishing calls with the PBX.
Disable rport Discovery	Check this box prevent the device from including the public WAN IP address in the contact information that is sent to the remote SIP servers. This will generally only need to be enabled when using an SBC in conjunction with a remote SIP server.
RTP Settings	
RTP Port (even)	Specify the port number used for the RTP stream after establishing a SIP call. This port number has to be an even number and defaults to 10500.
	Click the Save button to save your configuration settings. Note: You need to reboot for changes to take effect.
	Click on the Reboot button to reboot the system.

3. After changing the parameters, click **Save Settings**.

2.2.6 Configure the Night Ringer Parameters

When the Nightringer is enabled, the device will register as a second SIP extension. Registration does not have to be to the same server as the primary SIP registration. Any calls made to the Nightringer extension will cause the device to play a ring tone. There is no way to answer this call. The Nightringer is designed to be used in buildings where calls made after hours are directed to a ring group.

 <small>GENERAL ALERT</small>	<p>Caution Nightringer requires SIP Registration.</p>
---	--

1. Click on the **Nightringer** button to open the **Nightringer Configuration** page. See [Figure 2-16](#).

Figure 2-16. Nightringer Configuration Setup

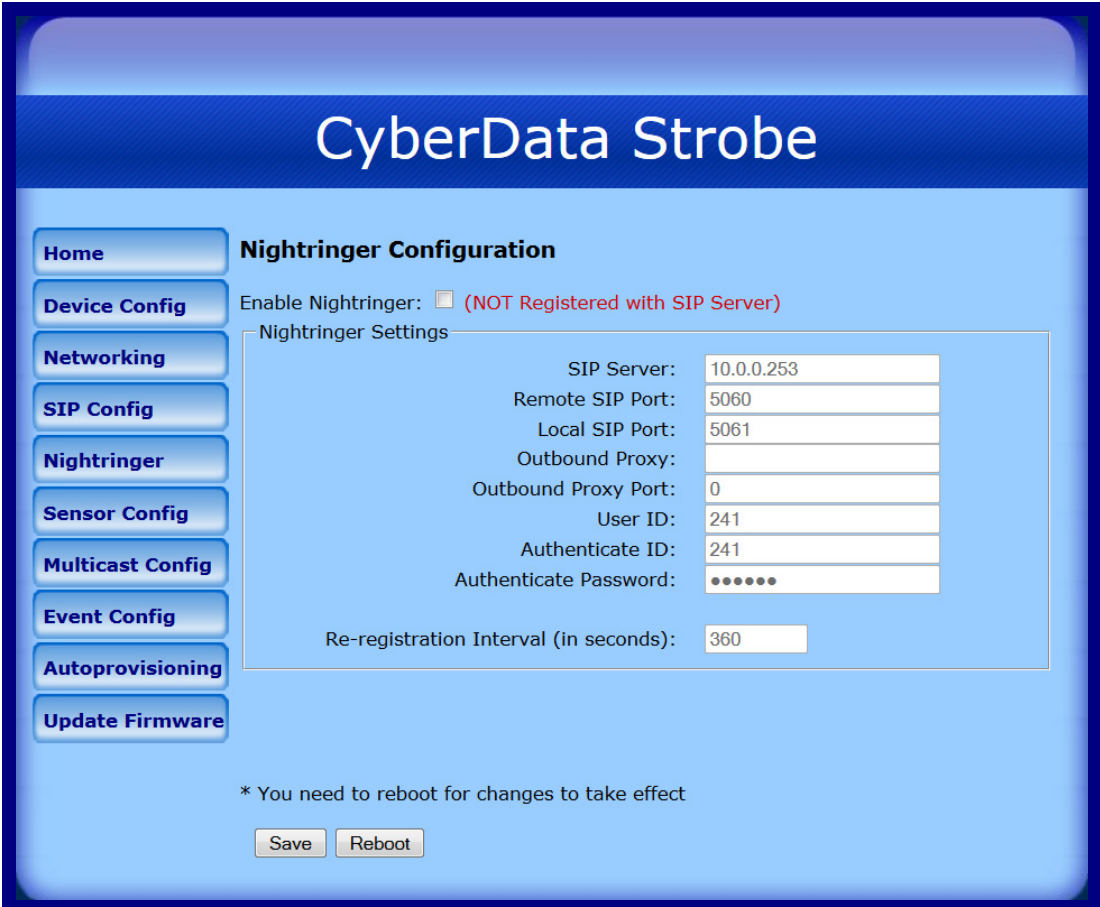

CyberData Strobe

Home

Device Config

Networking

SIP Config

Nightringer

Sensor Config

Multicast Config

Event Config

Autoprovisioning

Update Firmware

Nightringer Configuration

Enable Nightringer: (NOT Registered with SIP Server)

Nightringer Settings



SIP Server:	<input type="text" value="10.0.0.253"/>
Remote SIP Port:	<input type="text" value="5060"/>
Local SIP Port:	<input type="text" value="5061"/>
Outbound Proxy:	<input type="text"/>
Outbound Proxy Port:	<input type="text" value="0"/>
User ID:	<input type="text" value="241"/>
Authenticate ID:	<input type="text" value="241"/>
Authenticate Password:	<input type="password" value="••••••"/>

Re-registration Interval (In seconds):

* You need to reboot for changes to take effect

2. On the **Nightringer Configuration** page, enter values for the parameters indicated in [Table 2-11](#).

Table 2-11. Nightringer Configuration Parameters

Web Page Item	Description
Enable Nightringer	When the nightringer is enabled, the SIP Strobe will attempt to register a second extension with the SIP server. Any calls made to this extension will cause the strobe to flash.
Nightringer Settings	
SIP Server	Type the SIP server represented as either a numeric IP address in dotted decimal notation.
Remote SIP Port	Type the Remote SIP Port number (default 5060) (8 character limit).
Local SIP Port	Type the Local SIP Port number (default 5060) (8 character limit). Note: This value cannot be the same as the Local SIP Port found on the SIP Configuration Page .
Outbound Proxy	Type the Outbound Proxy as either a numeric IP address in dotted decimal notation or the fully qualified host name (255 character limit [FQDN]).
Outbound Proxy Port	Type the Outbound Proxy Port number (8 character limit).
User ID	Type the User ID (up to 64 alphanumeric characters).
Authenticate ID	Type the Authenticate ID (up to 64 alphanumeric characters).
Authenticate Password	Type the Authenticate Password (up to 64 alphanumeric characters).
Re-registration Interval (in seconds)	Type the SIP Registration lease time (in seconds).
	Click the Save button to save your configuration settings. Note: You need to reboot for changes to take effect.
	Click on the Reboot button to reboot the system.

3. After changing the parameters, click on the **Save** button.

2.2.7 Configure the Sensor Configuration Parameters

The sensor (pins 5 and 6) on the header can be used to monitor the open or closed state of a switch. There is an option on the **Sensor Configuration** page to trigger on an open or short condition on these pins.

The intrusion sensor is an optical sensor installed on the SIP Strobe board and will be activated when the SIP Strobe is removed from the case.

For each sensor there are two actions the SIP Strobe can take:

- Flash the LED until the sensor is deactivated (roughly 10 times/second)
- Activate the relay until the sensor is deactivated

1. Click **Sensor Config** to open the **Sensor Configuration** page (Figure 2-17).

Figure 2-17. Sensor Configuration Page

CyberData Strobe

Sensor Configuration

Home
Device Config
Networking
SIP Config
Nightringer
Sensor Config
Multicast Config
Event Config
Autoprovisioning
Update Firmware

Sensor Settings

Sensor Normally Closed: Yes No
Activate Relay:
Blink Strobe:

Test Sensor

Intrusion Sensor Settings

Activate Relay:
Blink Strobe:

Test Intrusion Sensor

* You need to reboot for changes to take effect

Save Reboot

2. On the **Sensor Configuration** page, enter values for the parameters indicated in [Table 2-12](#).

Table 2-12. Sensor Configuration Parameters

Web Page Item	Description
Sensor Settings	
Sensor Normally Closed	Select the inactive state of the sensors.
Activate Relay	Check this box to blink the strobe light until the sensor is deactivated.
Blink Strobe	Check this box to activate the blinking strobe until the sensor is deactivated.
<input type="button" value="Test Sensor"/>	Use this button to test the sensor.
Intrusion Sensor Settings	
Activate Relay	Check this box to activate the relay until the sensor is deactivated.
Blink Strobe	Check this box to blink the strobe light until the sensor is deactivated.
<input type="button" value="Test Intrusion Sensor"/>	Use this button to test the Intrusion sensor.
<input type="button" value="Save"/>	Click the Save button to save your configuration settings. Note: You need to reboot for changes to take effect.
<input type="button" value="Reboot"/>	Click on the Reboot button to reboot the system.

3. After changing the parameters, click **Save Settings**.

2.2.8 Configure the Multicast Parameters

The **Multicast Configuration** page allows the device to join up to ten paging zones for receiving ulaw/alaw encoded RTP audio streams.

A paging zone can consist of one or many CyberData multicast group-enabled products. There is no limit to how many speakers can be in a given paging zone. Each multicast group is defined by a multicast address and port number.

Each multicast group is assigned a priority, allowing simultaneously arriving pages to be serviced based on importance. Multicast groups are compatible with IGMP through version 3. The device supports simultaneous SIP and Multicast.

1. Click on the **Multicast Configuration** button to open the **Multicast Configuration** page. See [Figure 2-18](#).

Figure 2-18. Multicast Configuration Page

CyberData Strobe

Multicast Configuration

Enable Multicast operation:

Device Settings

priority	Address	port	Multicast Group Name
9	239.168.3.10	11000	Emergency
8	239.168.3.9	10000	MG8
7	239.168.3.8	9000	MG7
6	239.168.3.7	8000	MG6
5	239.168.3.6	7000	MG5
SIP calls are considered priority 4.5			
4	239.168.3.5	6000	MG4
3	239.168.3.4	5000	MG3
2	239.168.3.3	4000	MG2
1	239.168.3.2	3000	MG1
0	239.168.3.1	2000	Background Music



Port range can be from 2000-65535
Ports must be even numbers
Priority 9 is the highest and 0 is the lowest
A higher priority audio stream will always supercede a lower one
Priority 9 streams will play at maximum volume

* You need to reboot for changes to take effect

Save Reboot

2. On the **Multicast Configuration** page, enter values for the parameters indicated in [Table 2-13](#).

Table 2-13. Multicast Configuration Parameters

Web Page Item	Description
Enable Multicast Operation	Enables or disables multicast operation.
Device Settings	
Priority	Indicates the priority for the multicast group. Priority 9 is the highest (emergency streams). 0 is the lowest (background music). SIP calls are considered priority 4.5 . See Section 2.2.8.1, "Assigning Priority" for more details.
Address	Enter the multicast IP Address for this multicast group (15 character limit).
Port (range can be from 2000 to 65535)	Enter the port number for this multicast group (5 character limit). Note: The multicast ports have to be even values. The webpage will enforce this restriction.
Multicast Group Name	Assign a descriptive name for this multicast group (25 character limit).
	Click the Save button to save your configuration settings. Note: You need to reboot for changes to take effect.
	Click on the Reboot button to reboot the system.

3. After changing the parameters, click on the **Save** button.

2.2.8.1 Assigning Priority

When playing multicast streams, audio on different streams will preempt each other according to their priority in the list. An audio stream with a higher priority will interrupt a stream with a lower priority.

If both SIP and Multicast is enabled, SIP audio streams are considered priority **4.5**. SIP audio will interrupt multicast streams with priority **0** through **4** and will be interrupted by multicast streams with priority **5** through **9**.

During priority **9** multicast streams the volume level is set to maximum.

Note SIP calls, multicast streams, ring tones, ringback tones, and nightring tones are all prioritized.

Ringtones and Nightringtones

Ringtones all play at the same priority level. This means that it is possible to have a nightring tone and a normal ringtone playing at the same time.

2.2.9 Configure the Event Parameters

Click the **Event Config** button to open the **Event Configuration** page (Figure 2-19). The **Event Configuration** page specifies a remote server that can be used to receive HTTP POST events when actions take place on the board.

Figure 2-19. Event Configuration Page

CyberData Strobe

Event Configuration

Enable Event Generation:

Remote Event Server

Remote Event Server IP: 10.0.0.250

Remote Event Server Port: 8080

Remote Event Server URL: xmlparse_engine

Events

Enable Relay Activated Events:

Enable Relay Deactivated Events:

Enable Ring Events:

Enable Night Ring Events:

Enable Multicast Start Events:

Enable Multicast Stop Events:

Enable Power on Events:

Enable Security Events:



Enable 60 second Heartbeat Events:

* You need to reboot for changes to take effect

Save Test Event Reboot

Table 2-14 shows the web page items on the **Event Configuration** page.

Table 2-14. Event Configuration

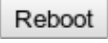
Web Page Item	Description
Enable Event Generation	When selected, Event Generation is enabled.
Remote Event Server	
Remote Event Server IP	Type the Remote Event Server IP address. (64 character limit)
Remote Event Server Port	Type the Remote Event Server port number. (8 character limit)
Remote Event Server URL	Type the Remote Event Server URL. (127 character limit)
Events	
Enable Relay Activated Events	When selected, Relay Activated Events are enabled.
Enable Relay Deactivated Events	When selected, Relay Deactivated Events are enabled.
Enable Ring Events	When selected, Ring Events are enabled.
Enable Night Ring Events	When selected, there is a notification when the device receives a night ring.
Enable Multicast Start Events	When selected, Multicast Start Events are enabled.
Enable Multicast Stop Events	When selected, Multicast Stop Events are enabled.
Enable Power On Events	When selected, Power On Events are enabled.
Enable Security Events	When selected, Security Events are enabled.
Enable 60 Second Heartbeat Events	When selected, 60 Second Heartbeat Events are enabled.
	Click the Save button to save your configuration settings. Note: You need to reboot for changes to take effect.
	Click on the Test Event button to test an event.
	Click on the Reboot button to reboot the system.

2.2.9.1 Example Packets for Events

The server and port are used to point to the listening server and the 'Remote Event Server URL' is the destination URL (typically the script running on the remote server that's used to parse and process the POST events).

Note The XML is URL-encoded before transmission so the following examples are not completely accurate.

Here are example packets for every event:

```
POST xmlparse_engine HTTP/1.1
Host: 10.0.3.79
User-Agent: CyberData/1.0.0
Content-Length: 197
Content-Type: application/x-www-form-urlencoded

<?xml version="1.0" encoding="ISO-8859-1"?>
<cyberdata NAME='CyberData SIP Device' MAC='0020f70015b6'>
<event>POWERON</event>
</cyberdata>
```

```
POST xmlparse_engine HTTP/1.1
Host: 10.0.3.79
User-Agent: CyberData/1.0.0
Content-Length: 199
Content-Type: application/x-www-form-urlencoded

<?xml version="1.0" encoding="ISO-8859-1"?>
<cyberdata NAME='CyberData SIP Device' MAC='0020f70015b6'>
<event>HEARTBEAT</event>
</cyberdata>
```

```
POST xmlparse_engine HTTP/1.1
Host: 10.0.3.79
User-Agent: CyberData/1.0.0
Content-Length: 196
Content-Type: application/x-www-form-urlencoded

<?xml version="1.0" encoding="ISO-8859-1"?>
<cyberdata NAME='CyberData SIP Device' MAC='0020f70015b6'>
<event>BUTTON</event>
</cyberdata>
```

```
POST xmlparse_engine HTTP/1.1
Host: 10.0.3.79
User-Agent: CyberData/1.0.0
Content-Length: 201
Content-Type: application/x-www-form-urlencoded

<?xml version="1.0" encoding="ISO-8859-1"?>
<cyberdata NAME='CyberData SIP Device' MAC='0020f70015b6'>
<event>CALL_ACTIVE</event>
</cyberdata>
POST xmlparse_engine HTTP/1.1
```

```
Host: 10.0.3.79
User-Agent: CyberData/1.0.0
Content-Length: 205
Content-Type: application/x-www-form-urlencoded

<?xml version="1.0" encoding="ISO-8859-1"?>
<cyberdata NAME='CyberData SIP Device' MAC='0020f70015b6'>
<event>CALL_TERMINATED</event>
</cyberdata>

POST xmlparse_engine HTTP/1.1
Host: 10.0.3.79
User-Agent: CyberData/1.0.0
Content-Length: 197
Content-Type: application/x-www-form-urlencoded

<?xml version="1.0" encoding="ISO-8859-1"?>
<cyberdata NAME='CyberData SIP Device' MAC='0020f70015b6'>
<event>RINGING</event>
</cyberdata>

POST xmlparse_engine HTTP/1.1
Host: 10.0.3.79
User-Agent: CyberData/1.0.0
Content-Length: 234
Content-Type: application/x-www-form-urlencoded

<?xml version="1.0" encoding="ISO-8859-1"?>
<cyberdata NAME='CyberData SIP Device' MAC='0020f70015b6'>
<event>MULTICAST_START</event>
<index>8</index>
</cyberdata>

POST xmlparse_engine HTTP/1.1
Host: 10.0.3.79
User-Agent: CyberData/1.0.0
Content-Length: 233
Content-Type: application/x-www-form-urlencoded

<?xml version="1.0" encoding="ISO-8859-1"?>
<cyberdata NAME='CyberData SIP Device' MAC='0020f70015b6'>
<event>MULTICAST_STOP</event>
<index>8</index>
</cyberdata>

POST xmlparse_engine HTTP/1.1
Host: 10.0.3.79
User-Agent: CyberData/1.0.0
Content-Length: 234
Content-Type: application/x-www-form-urlencoded
<?xml version="1.0" encoding="ISO-8859-1"?>
<cyberdata NAME='CyberData SIP Device' MAC='0020f70015b6'>
<event>RELAY_ACTIVATED</event>
</cyberdata>
POST xmlparse_engine HTTP/1.1
```

```
Host: 10.0.3.79
User-Agent: CyberData/1.0.0
Content-Length: 234
Content-Type: application/x-www-form-urlencoded
<?xml version="1.0" encoding="ISO-8859-1"?>
<cyberdata NAME='CyberData SIP Device' MAC='0020f70015b6'>
<event>RELAY_DEACTIVATED</event>
</cyberdata>
```

```
POST xmlparse_engine HTTP/1.1
Host: 10.0.3.79
User-Agent: CyberData/1.0.0
Content-Length: 234
Content-Type: application/x-www-form-urlencoded
<?xml version="1.0" encoding="ISO-8859-1"?>
<cyberdata NAME='CyberData SIP Device' MAC='0020f70015b6'>
<event>NIGHTRINGING</event>
</cyberdata>
```

2.2.10 Configure the Autoprovisioning Parameters

Autoprovisioning can be used to configure your device automatically on boot, after a periodic delay, after sitting idle for a period of time, or at a specified time.

The autoprovisioning file contains the board configuration in xml format. Autoprovisioned values in this file will override values stored in on-board memory.

The autoprovisioning file can be hosted with a tftp or a web server and by default is named according to the MAC address of the device (for example: 0020f7350058.config). The autoprovisioning filename can also be specified.

The device does not have a real time clock but can sync with a network time server on boot.

1. Click the **Autoprovisioning** button to open the **Autoprovisioning Configuration** page. See [Figure 2-20](#).

Figure 2-20. Autoprovisioning Configuration Page

CyberData Strobe

Autoprovisioning

Autoprovisioning

Enable Autoprovisioning:

Get Autoprovisioning from DHCP:

Download Protocol: HTTP TFTP

Autoprovisioning Server (IP Address): 10.0.0.254

Autoprovisioning Filename:

Autoprovisioning autoupdate (in minutes):

Autoprovision at time (HHMMSS):

Autoprovision when idle (in minutes > 10):

Clock

NTP Server: north-america.pool.ntp.org

Posix Timezone String (see manual): PST8PDT,M3.2.0/2:00:00,M11.1.0/2:00:01

Set Time with external NTP server on boot:

Periodically update with time server:

Time update period (in hours):

Current Time





Current Time in 24 hour format (HHMMSS): 223623

* Autoprovisioning file name: 0020f70232a3.config

* You need to reboot for changes to take effect

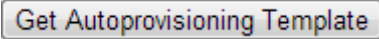
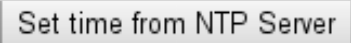
- On the **Autoprovisioning Configuration** page, you may enter values for the parameters indicated in [Table 2-15](#).

Table 2-15. Autoprovisioning Configuration Parameters

Web Page Item	Description
Autoprovisioning	
Enable Autoprovisioning	See Section 2.2.10.1, "Autoprovisioning" .
Get Autoprovisioning from DHCP	See Section 2.2.10.1, "Autoprovisioning" .
Download Protocol	Allows you to select whether the autoprovisioning file is acquired via TFTP or HTTP .
Autoprovisioning Server (IP Address)	See Section 2.2.10.1, "Autoprovisioning" (15 character limit).
Autoprovisioning Filename	Type the desired name for the autoprovisioning file.
Autoprovisioning Autoupdate (in minutes)	Type the desired time (in minutes) that you want the Autoprovisioning feature to update (6 character limit).
Autoprovision at time (HHMMSS)	Type the desired time of day that you want the Autoprovisioning feature to update (must be 6 characters).
Autoprovision when idle (in minutes > 10)	Type the desired time (in minutes greater than 10) that you want the Autoprovisioning feature to update after a certain amount of idle time (6 character limit).
	Press the Get Autoprovisioning Template button to create an autoprovisioning file for this unit. See Section 2.2.10.2, "Get Autoprovisioning Template Button"
Clock	
NTP Server	Allows you to select the NTP server (64 character limit).
Posix Timezone String	See Section 2.2.10.3, "Time Zone Strings" (43 character limit).
Set Time with External NTP Server on boot	When selected, the time is set with an external NTP server when the device restarts.
Periodically update with time server	When selected, the time is periodically updated with a time server.
Time update period (in hours)	Allows you to select the time updated period (in hours) (4 character limit).
	Allows you to set the time from the NTP server.
Current Time	
Current Time (UTC) in 24 hour format (HHMMSS)	Allows you to input the current time in the 24 hour format. (6 character limit)
	Click on this button to set the clock after entering the current time.
	Click on the Save button to save your configuration settings. Note: You need to reboot for changes to take effect.
	Click on the Reboot button to reboot the system.

2.2.10.1 Autoprovisioning

Autoprovisioning File It is not necessary to set every option found in the autoprovisioning template. As long as the XML is valid, the file can contain any subset. Options not autoprovisioned will default to the values stored in the on board memory. For example if you only wanted to modify the device name, the following would be a valid autoprovisioning file:

```
<?xml version="1.0" encoding="utf-8" ?>
<specific>
  <MiscSettings>
    <DeviceName>auto Strobe</DeviceName>
  </MiscSettings>
</specific>
```

Get Autoprovisioning from DHCP When this option is checked, the device will automatically fetch its autoprovisioning server address from the DHCP server. The device will use the address specified in **OPTION 150** (TFTP-server-name) or **OPTION 66**. If both options are set, the device will use **OPTION 150**.

Refer to the documentation of your DHCP server for setting up **OPTION 150**.

To set up a Linux DHCPD server to serve autoprovisioning information (in this case using both option 66 and 150), here's an example dhcpd.conf:

```
# dhcpd.conf
#
# Configuration file for ISC dhcpd (see 'man dhcpd.conf')
#
ddns-update-style ad-hoc;

option option-150 code 150 = ip-address;

subnet 10.0.0.0 netmask 255.0.0.0 {
    max-lease-time 120;
    default-lease-time 120;

    option routers                10.0.0.1;
    option subnet-mask            255.0.0.0;

    option domain-name            "voiplab";
    option domain-name-servers    10.0.0.1;

    option time-offset             -8;      # Pacific Standard Time

    option tftp-server-name        "10.0.0.254";

    option option-150              10.0.0.254;

    range 10.10.0.1 10.10.2.1;}
```

- Autoprovisioning Server (IP Address) Instead of using DHCP to provide the autoprovisioning tftp server address, you can specify an address manually.
- Autoprovisioning Autoupdate When the device is set to autoprovision either after a period of time, or when idle, or at a time of day, the device will do the following:
- Re-download the autoprovisioning file.
 - Compare this new file to the one downloaded on boot, and if it finds differences, force a system reset.
 - After rebooting, the board will configure itself according to this new file.
- Autoprovisioned Firmware Upgrades An Autoprovisioned firmware upgrade only happens after a reboot, will take roughly three minutes, and the web page will be unresponsive during this time.

The '**FirmwareVersion**' value in the xml file *must* match the version stored in the '**FirmwareFile**'.

```
<FirmwareVersion>v10.0.1</FirmwareVersion>  
<FirmwareFile>1001-strobe-uImage</FirmwareFile>
```

If these values are mismatched, the board can get stuck in a loop where it goes through the following sequence of actions:

1. The board downloads and writes a new firmware file.
2. After the next reboot, the board recognizes that the firmware version does not match.
3. The board downloads and writes the firmware file again.

CyberData has timed a firmware upgrade at 140 seconds. Therefore, if you suspect the board is stuck in a loop, either remove or comment out the **FirmwareVersion** line in the XML file and let the board boot as it normally does.

- Autoprovisioned Audio Files Audio files are stored in non-volatile memory and an autoprovisioned audio file will only have to be downloaded once for each device. Loading many audio files to the device from the web page could cause it to appear unresponsive. If this happens, wait until the transfer is complete and then refresh the page.

The device uses the file name to determine when to download a new audio file. This means that if you used autoprovisioning to upload a file and then changed the contents of this file at the TFTP server, the device will not recognize that the file has changed (because the file name is the same).

- Since audio files are stored in non-volatile memory, if autoprovisioning is disabled after they have been loaded to the board, the audio file settings will not change. You can force a change to the audio files on the board by clicking **Restore Default** on the **Audio Configuration** page or by changing the autoprovisioning file with “**default**” set as the file name.

2.2.10.2 Get Autoprovisioning Template Button

The **Get Autoprovisioning Template** button allows the user to generate, download, edit, and then store an autoprovisioning template on the server that serves the autoprovisioning files for devices.

To generate an autoprovisioning template directly from the device, complete the following steps:

1. On the **Autoprovisioning** page, click on the **Get Autoprovisioning Template** button.
2. You will see a window prompting you to save a configuration file (**.config**) to a location on your computer ([Figure 2-21](#)). The configuration file is the basis for the default configuration settings for your unit).
3. Choose a location to save the configuration file and click on **OK**. See [Figure 2-21](#).

Figure 2-21. Configuration File

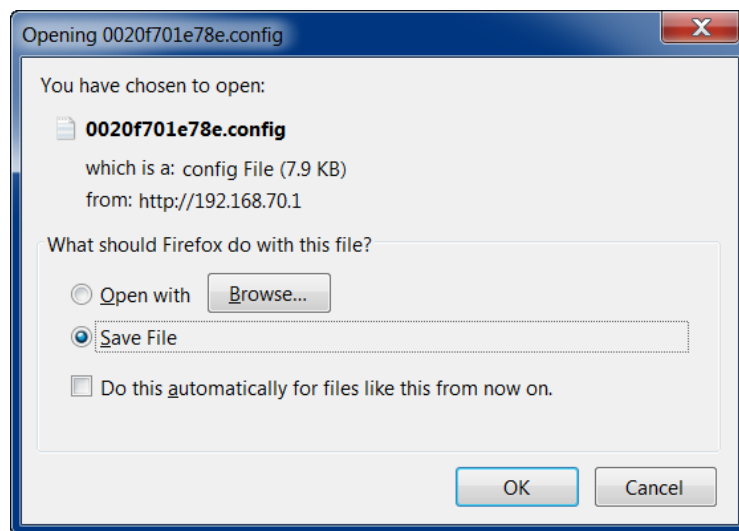

4. At this point, you can open and edit the autoprovisioning template to change the configuration settings in the template for the unit.
5. You can then upload the autoprovisioning file to a TFTP or HTTP server where the file can be loaded onto other devices.

2.2.10.3 Time Zone Strings

The posix time zone string tells the internal date and time utilities how to handle daylight savings time for different time zones. [Table 2-16](#) shows some common strings.

Table 2-16. Common Time Zone Strings

Time Zone	Time Zone String
US Pacific time	PST8PDT,M3.2.0/2:00:00,M11.1.0/2:00:00
US Mountain time	MST7MDT,M3.2.0/2:00:00,M11.1.0/2:00:00
US Eastern Time	EST5EDT,M3.2.0/2:00:00,M11.1.0/2:00:00
Phoenix Arizona ^a	MST7
US Central Time	CST6DST,M3.2.0/2:00:00,M11.1.0/2:00:00

a. Phoenix, Arizona does not use daylight savings time.

[Table 2-17](#) shows a breakdown of the parts that constitute the following time zone string:

- ***CST6DST,M3.2.0/2:00:00,M11.1.0/2:00:00***

Table 2-17. Time Zone String Parts

Time Zone String Part	Meaning
CST6CDT	The time zone offset from GMT and three character identifiers for the time zone.
CST	Central Standard Time
6	The (hour) offset from GMT/UTC
CDT	Central Daylight Time
M3.2.0/2:00:00	The date and time when daylight savings begins.
M3	The third month (March)
.2	The 2nd occurrence of the day (next item) in the month
.0	Sunday
/2:00:00	Time of day to change
M11.1.0/2:00:00	The date and time when daylight savings ends.
M11	The eleventh month (November)
.1	The 1st occurrence of the day (next item) in the month
.0	Sunday
/2:00:00	Time of day to change

Time Zone String Examples **Table 2-18** has some more examples of time zone strings.

Table 2-18. Time Zone String Examples

Time Zone	Time Zone String
Tokyo ^a	IST-9
Berlin ^b	CET-1MET,M3.5.0/1:00,M10.5.0/1:00

- a. Tokyo does not use daylight savings time.
- b. For Berlin, daylight savings time starts on the last Sunday in March at 01:00 UTC, and ends on the last Sunday in October at 01:00 UTC, and is one hour ahead of UTC.

Time Zone Identifier A user-definable three or four character time zone identifier (such as PST, EDT, IST, MUT, etc) is needed at the beginning of the posix time zone string to properly set the time. However, the specific letters or numbers used for the time zone identifier are not important and can be any three or four letter or number combination that is chosen by the user. However, the time zone identifier cannot be blank.

Figure 2-22. Three or Four Character Time Zone Identifier

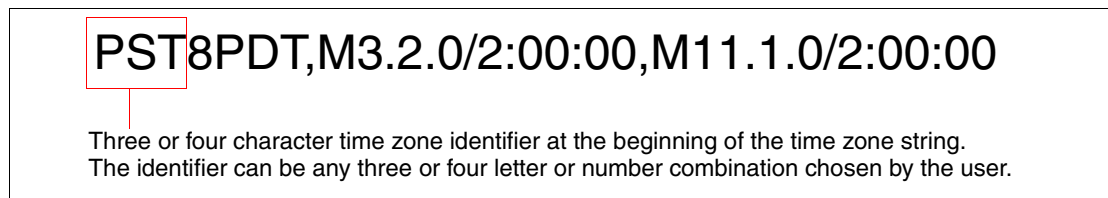

You can also use the following URL when a certain time zone applies daylight savings time:

<http://www.timeanddate.com/time/dst/2011.html>

World GMT Table **Table 2-19** has information about the GMT time in various time zones.

Table 2-19. World GMT Table

Time Zone	City or Area Zone Crosses
GMT-12	Eniwetok
GMT-11	Samoa
GMT-10	Hawaii
GMT-9	Alaska
GMT-8	PST, Pacific US
GMT-7	MST, Mountain US
GMT-6	CST, Central US
GMT-5	EST, Eastern US
GMT-4	Atlantic, Canada
GMT-3	Brazilia, Buenos Aries
GMT-2	Mid-Atlantic
GMT-1	Cape Verdes
GMT	Greenwich Mean Time, Dublin

Table 2-19. World GMT Table (continued)

Time Zone	City or Area Zone Crosses
GMT+1	Berlin, Rome
GMT+2	Israel, Cairo
GMT+3	Moscow, Kuwait
GMT+4	Abu Dhabi, Muscat
GMT+5	Islamabad, Karachi
GMT+6	Almaty, Dhaka
GMT+7	Bangkok, Jakarta
GMT+8	Hong Kong, Beijing
GMT+9	Tokyo, Osaka
GMT+10	Sydney, Melbourne, Guam
GMT+11	Magadan, Soloman Is.
GMT+12	Fiji, Wellington, Auckland

2.3 Upgrade the Firmware and Reboot the SIP Strobe

 <p>GENERAL ALERT</p>	<p>Caution</p> <p>Equipment Hazard: Devices with a serial number that begins with 0871xxxxx can only run firmware versions 10.0.0 or later.</p>
--	---

To upload the firmware from your computer:

1. Retrieve the latest SIP Strobe firmware file from the SIP Strobe **Downloads** page at:
<http://www.cyberdata.net/products/voip/digitalanalog/strobe/downloads.html>
2. Unzip the firmware version file. This file may contain the following:
 - Firmware file
 - Release notes
3. Log in to the SIP Strobe home page as instructed in [Section 2.2.2, "Log in to the Configuration Home Page"](#).
4. Click the **Update Firmware** button to open the **Upgrade Firmware** page. See [Figure 2-23](#).

Figure 2-23. Upgrade Firmware Page

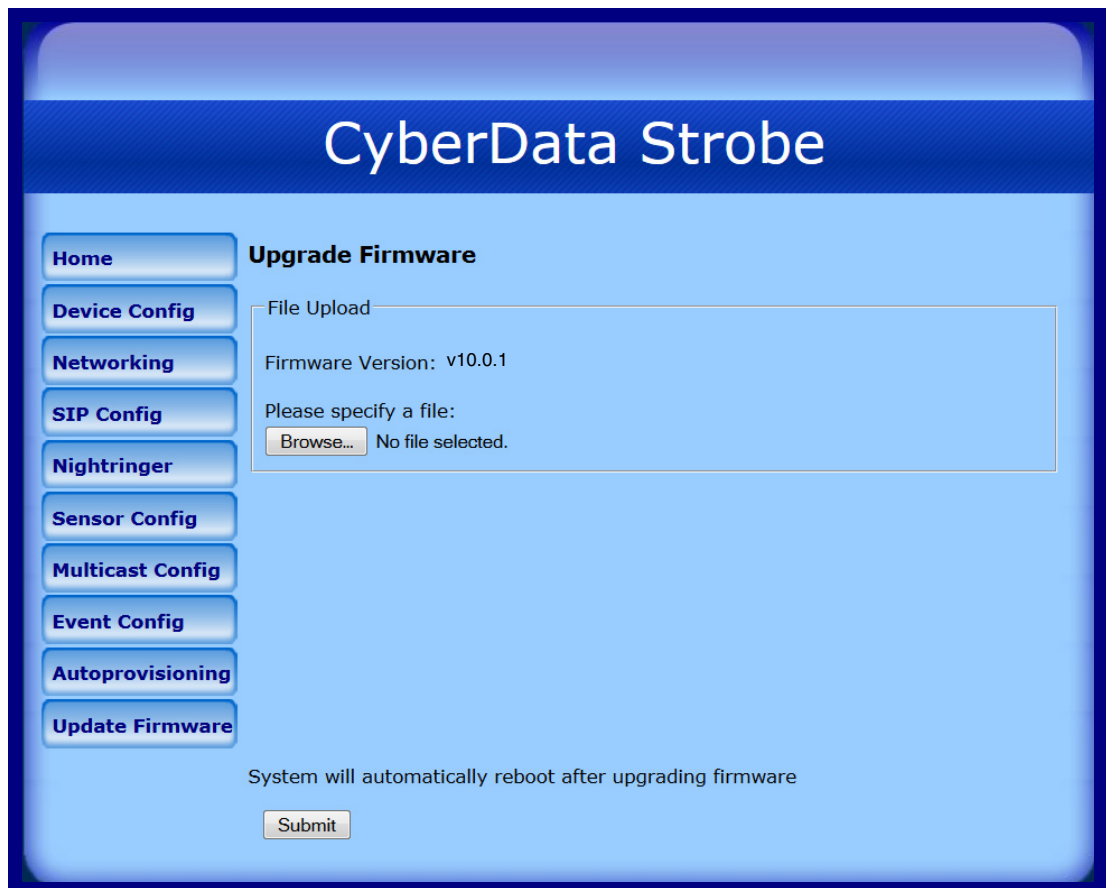



5. Select **Browse**, and then navigate to the location of the SIP Strobe firmware file.
6. Click **Submit**.

Note This starts the upgrade process. Once the SIP Strobe has uploaded the file, the **Uploading Firmware** countdown page appears, indicating that the firmware is being written to flash. The SIP Strobe will automatically reboot when the upload is complete. When the countdown finishes, the **Upgrade Firmware** page will refresh. The uploaded firmware filename should be displayed in the system configuration (indicating successful upload and reboot).

Table 2-20 shows the web page items on the **Upgrade Firmware** page.

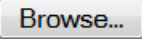
Table 2-20. Firmware Upgrade Parameters

Web Page Item	Description
File Upload	
Firmware Version	Shows the current firmware version.
	Use the Browse button to navigate to the location of the firmware file that you want to upload.
	Click on the Submit button to automatically upload the selected firmware and reboot the system.

2.3.1 Reboot the SIP Strobe

To reboot a SIP Strobe:

1. Log in to the web page as instructed in [Section 2.2.2, "Log in to the Configuration Home Page"](#).
2. Click the **Reboot** button ([Figure 2-24](#)). A normal restart will occur.

Figure 2-24. Reboot System Section

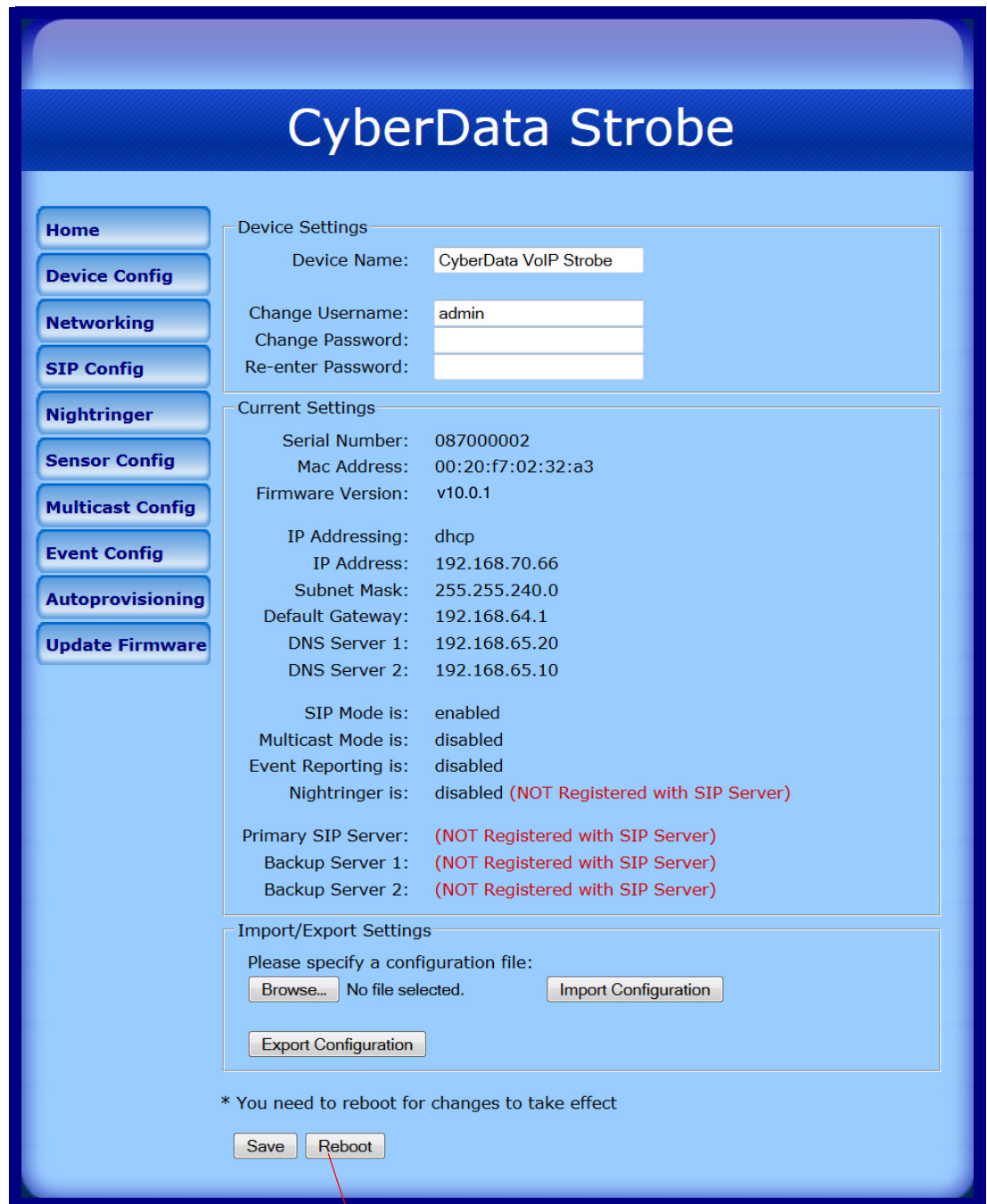

Reboot

2.4 Command Interface

Some functions on the device can be activated using simple POST commands to the web interface. The examples in [Table 2-21](#) use the free unix utility, **wget** commands. However, any program that can send HTTP POST commands to the device should work.

2.4.1 Command Interface Post Commands

Note These commands require an authenticated session (a valid username and password to work).

Table 2-21. Command Interface Post Commands

Device Action	HTTP Post Command ^a
Trigger relay (for configured delay)	wget --user admin --password admin --auth-no-challenge --quiet -O /dev/null "http://10.0.3.71/cgi-bin/command.cgi" --post-data "test_relay=yes"
Place call to extension (example: extension 130)	wget --user admin --password admin --auth-no-challenge --quiet -O /dev/null "http://10.0.3.71/cgi-bin/command.cgi" --post-data "call=130"
Terminate active call	wget --user admin --password admin --auth-no-challenge --quiet -O /dev/null "http://10.0.3.71/cgi-bin/command.cgi" --post-data "terminate=yes"
Force reboot	wget --user admin --password admin --auth-no-challenge --quiet -O /dev/null "http://10.0.3.71/cgi-bin/command.cgi" --post-data "reboot=yes"
Trigger the Door Sensor Test (Sensor Config page)	wget --user admin --password admin --auth-no-challenge --quiet -O /dev/null "http://10.0.3.71/cgi-bin/sensorconfig.cgi" --post-data "doortest=yes"
Trigger the Intrusion Sensor Test (Sensor Config page)	wget --user admin --password admin --auth-no-challenge --quiet -O /dev/null "http://10.0.3.71/cgi-bin/sensorconfig.cgi" --post-data "intrusiontest=yes"

a. Type and enter all of each http POST command on one line.

Appendix A: Mounting the SIP Strobe

A.1 Mount the SIP Strobe

Before you mount the SIP Strobe, make sure that you have received all the parts for each SIP Strobe. Refer to [Table A-1](#).

Table A-1. Wall Mounting Components (Part of the Accessory Kit)

Quantity	Part Name	Illustration
4	#6 x 1.5 inches Sheet Metal Screw	
4	#6 Ribbed Plastic Anchor	

Table A-2. Gang Box Mounting Components

Quantity	Part Name	Illustration
4	#6-32 x 0.625-inch Flat-Head Machine Screw.	

After the SIP Strobe is assembled, plug the Ethernet cable into the SIP Strobe Assembly (see [Figure A-25](#)).

[Section 2.1.4, "Network Connectivity"](#) explains how the **Link** and **Status** LEDs work.

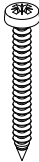
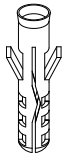
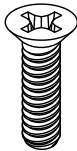
Figure A-25. Network Connector Prior to Installation

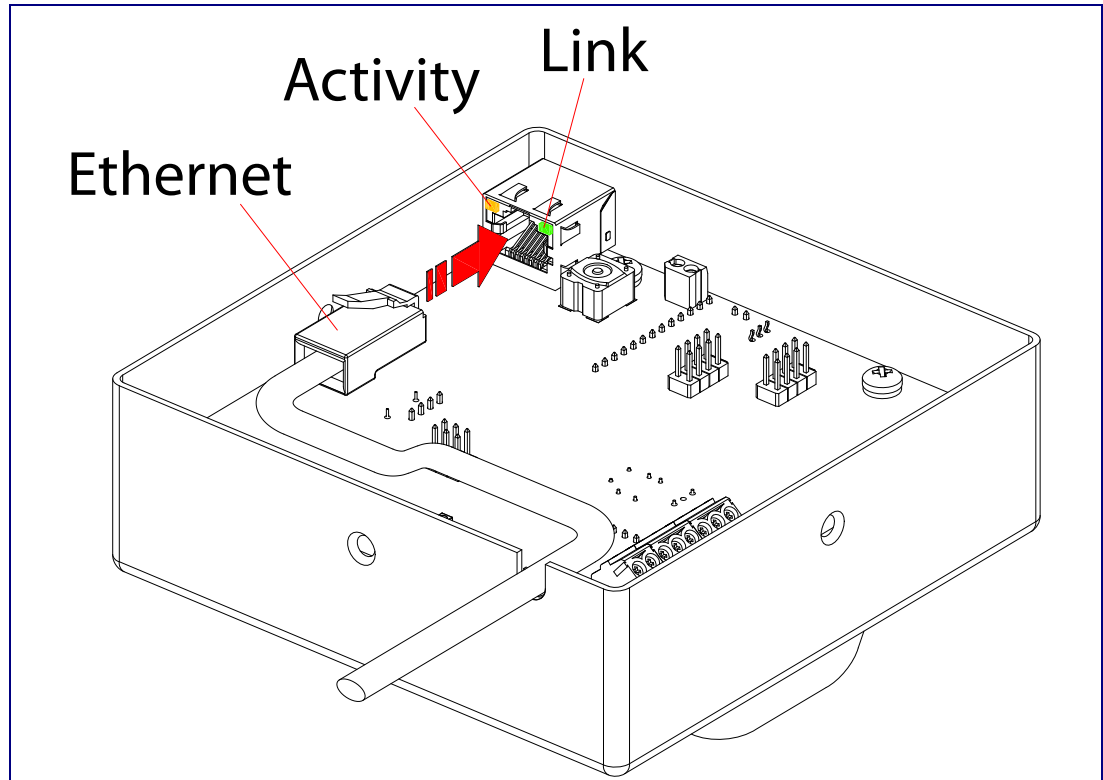

Figure A-26 shows the mounting options for the SIP Strobe.

Note Be sure to connect the SIP Strobe up to the Earth Ground.

Figure A-26. Mounting Options

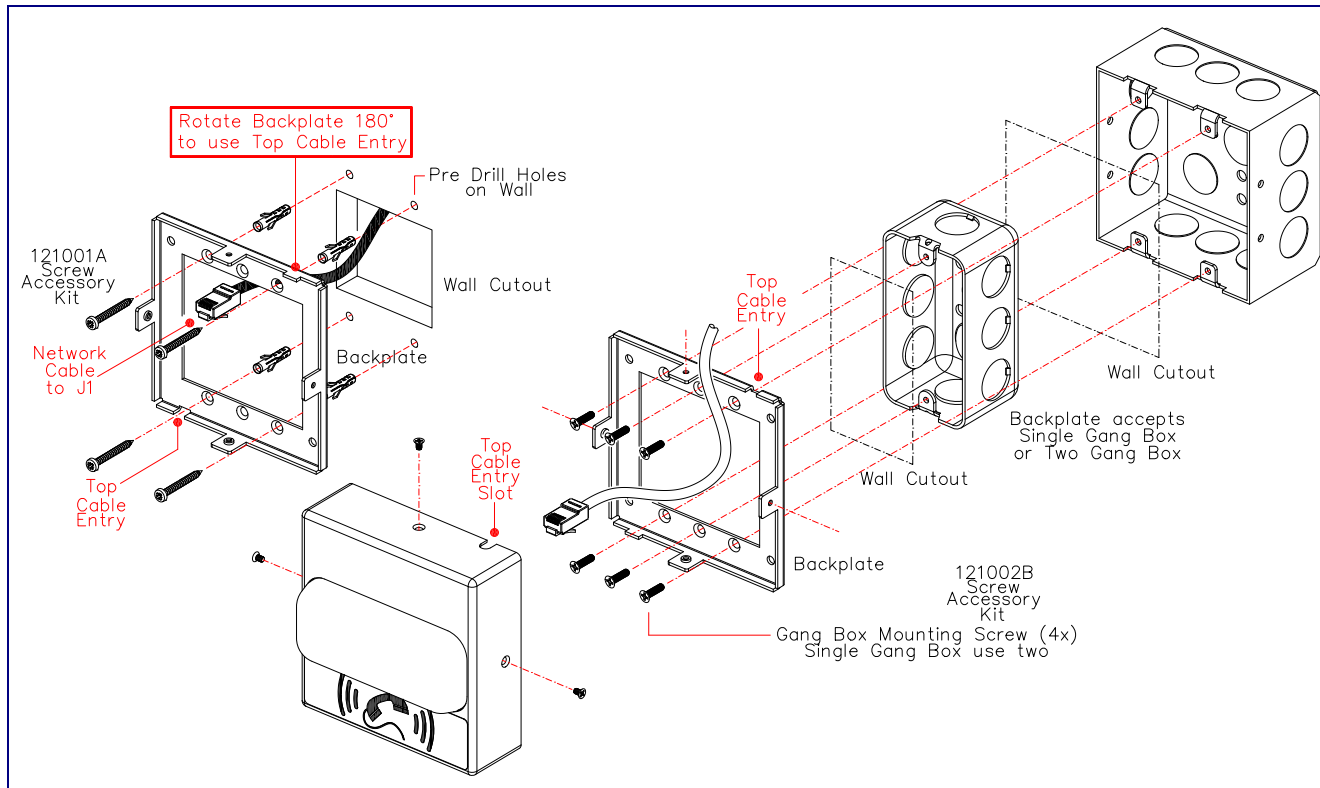
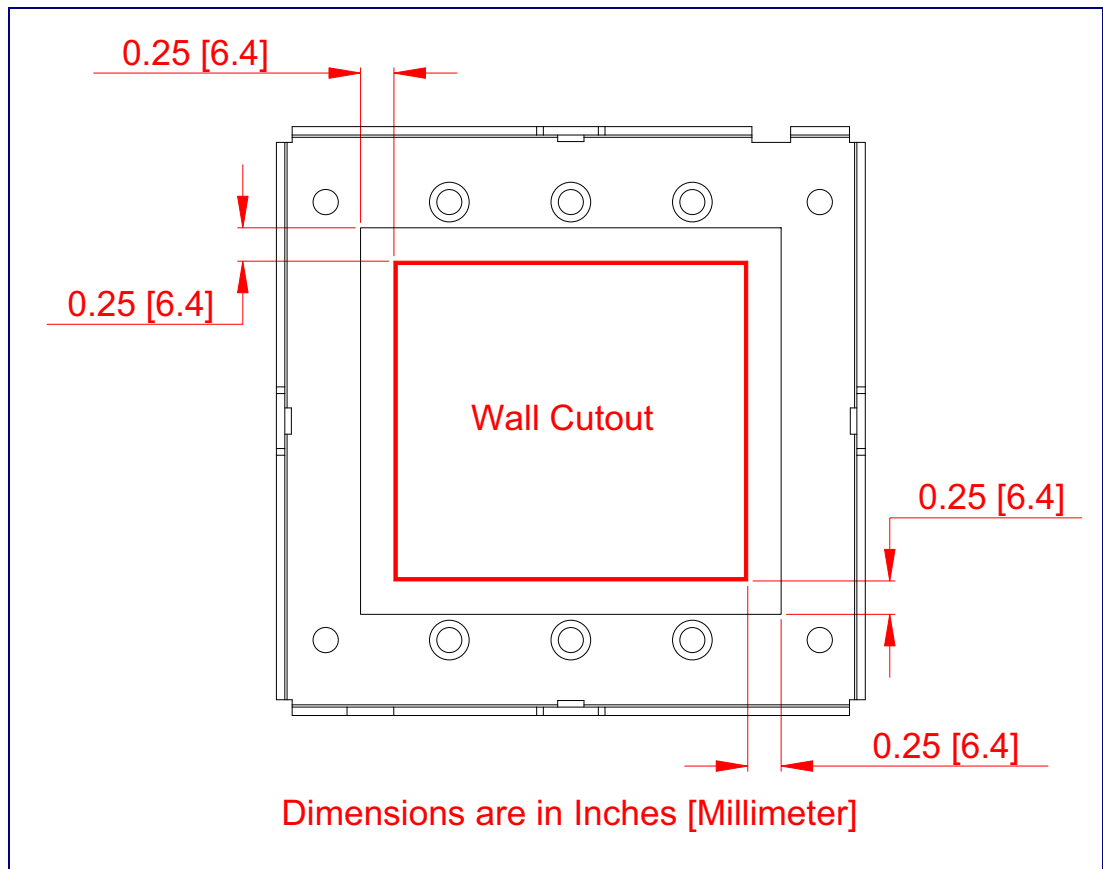

Figure A-27 shows the maximum recommended wall cutout dimensions for mounting the SIP Strobe.

Figure A-27. Maximum Recommended Wall Cutout Dimensions



Appendix B: Troubleshooting/Technical Support

B.1 Frequently Asked Questions (FAQ)

A list of frequently asked questions (FAQs) are available on the SIP Strobe product page at:

<http://www.cyberdata.net/products/voip/digitalanalog/strobe/faqs.html>

Select the support page for your product to see a list of frequently asked questions for the CyberData product:

B.2 Documentation

The documentation for this product is released in an English language version only. You can download PDF copies of CyberData product documentation from the SIP Strobe product page at:

<http://www.cyberdata.net/products/voip/digitalanalog/strobe/docs.html>

B.3 Contact Information

Contact	<p>CyberData Corporation 3 Justin Court Monterey, CA 93940 USA www.CyberData.net Phone: 800-CYBERDATA (800-292-3732) Fax: 831-373-4193</p>
Sales	<p>Sales 831-373-2601 Extension 334</p>
Technical Support	<p>The fastest way to get technical support for your VoIP product is to submit a VoIP Technical Support form at the following website:</p> <p>http://www.cyberdata.net/support/contactsupportvoip.php</p> <p>Phone: (831) 373-2601, Ext. 333 Email: support@cyberdata.net</p>
Returned Materials Authorization	<p>To return the product, contact the Returned Materials Authorization (RMA) department:</p> <p>Phone: 831-373-2601, Extension 136 Email: RMA@CyberData.net</p> <p>When returning a product to CyberData, an approved CyberData RMA number must be printed on the outside of the original shipping package. No product will be accepted for return without an approved RMA number. Send the product, in its original package, to the following address:</p> <p>CyberData Corporation 3 Justin Court Monterey, CA 93940 Attention: RMA "your RMA number"</p>
RMA Status Form	<p>If you need to inquire about the repair status of your product(s), please use the CyberData RMA Status form at the following web address:</p> <p>http://www.cyberdata.net/support/rmastatus.html</p>

B.4 Warranty

CyberData warrants its product against defects in material or workmanship for a period of two years from the date of purchase. Should the product fail Within Warranty, CyberData will repair or replace the product free of charge. This warranty includes all parts and labor.

Should the product fail Out of the Warranty period, a flat rate repair charge of one half of the purchase price of the product will be assessed. Repairs that are Within Warranty period but are damaged by improper installation, modification, or abuse are deemed Out of Warranty and will be charged at the Out of Warranty rate. A device is deemed Out of Warranty when its purchase date is longer than two years or when the device has been damaged due to human error during installation, modification, or abuse. A replacement unit will be offered at full cost if the device cannot be repaired.

End of Life Devices are included under this policy. End of Life devices are devices that are no longer produced or sold. Technical support is still available for these devices. However, no firmware revisions or updates will be provided. If an End of Life device cannot be repaired, the replacement offered may be the current version of the device.

Products shipped to CyberData, both within and out of warranty, are shipped at the expense of the customer. CyberData will pay return shipping charges for repaired products.

CyberData shall not under any circumstances be liable to any person for any special, incidental, indirect or consequential damages, including without limitation, damages resulting from use or malfunction of the products, loss of profits or revenues or costs of replacement goods, even if CyberData is informed in advance of the possibility of such damages.

B.4.1 Warranty & RMA Returns within the United States

If service is required, you must contact CyberData Technical Support prior to returning any products to CyberData. Our Technical Support staff will determine if your product should be returned to us for further inspection. If Technical Support determines that your product needs to be returned to CyberData, an RMA number will be issued to you at this point.

Your issued RMA number must be printed on the outside of the shipping box. No product will be accepted for return without an approved RMA number. The product in its original package should be sent to the following address:

CyberData Corporation
3 Justin Court.
Monterey, CA 93940
Attn: RMA "xxxxxx"

B.4.2 Warranty & RMA Returns Outside of the United States

If you purchased your equipment through an authorized international distributor or reseller, please contact them directly for product repairs.

B.4.3 Spare in the Air Policy

CyberData now offers a *Spare in the Air* no wait policy for warranty returns within the United States and Canada. More information about the *Spare in the Air* policy is available at the following web address:

<http://www.cyberdata.net/support/warranty/spareintheair.html>

B.4.4 Return and Restocking Policy

For our authorized distributors and resellers, please refer to your CyberData Service Agreement for information on our return guidelines and procedures.

For End Users, please contact the company that you purchased your equipment from for their return policy.

B.4.5 Warranty and RMA Returns Page

The most recent warranty and RMA information is available at the CyberData Warranty and RMA Returns Page at the following web address:

<http://www.cyberdata.net/support/warranty/index.html>

Index

Numerics

16 AWG gauge wire 6

A

AC voltages 2
 AC voltages, enclosure is not rated 7
 act light 12
 activate relay (intrusion sensor) 29
 activate relay (sensor) 29
 address, configuration login 16
 audio encodings 3
 Autoprovision at time (HHMMSS) 38
 autoprovision at time (HHMMSS) 38
 autoprovision when idle (in minutes > 10) 38
 autoprovisioning 38
 autoprovisioned audio files 40
 autoprovisioned firmware upgrades 40
 autoprovisioning autoupdate 40
 autoprovisioning from DHCP 39
 autoprovisioning server (IP address) 40
 get autoprovisioning template button 38
 autoprovisioning autoupdate (in minutes) 38
 autoprovisioning configuration 37, 38
 autoprovisioning filename 38
 autoprovisioning server (IP Address) 38
 auxiliary relay 7
 auxiliary relay wiring diagram 8

B

backup SIP server 1 24
 backup SIP server 2 24
 backup SIP servers, SIP server
 backups 24
 blink strobe (intrusion sensor) 29
 blink strobe (sensor) 29

C

changing
 the web access password 19
 Cisco SRST 24
 command interface 48
 commands 48

configurable parameters 18, 20, 22, 24, 46
 configuration 18
 default IP settings 14
 door sensor 28
 intrusion sensor 28
 network 21
 SIP 23
 using Web interface 14
 configuration home page 17
 configuration page
 configurable parameters 18, 20, 22, 24, 46
 contact information 54
 contact information for CyberData 54
 CyberData contact information 54

D

default
 device settings 57
 gateway 14
 IP address 14
 subnet mask 14
 username and password 14
 web login username and password 17
 default device settings 13
 default gateway 14, 22
 default IP settings 14
 default login address 16
 device configuration 19
 device configuration parameters 38
 the device configuration page 37
 device configuration page 19
 device configuration parameters 20
 device configuration password
 changing for web configuration access 19
 DHCP Client 3
 DHCP IP addressing 22
 dimensions 4
 discovery utility program 16
 DNS server 22
 door sensor 29
 door strike
 cannot be powered by alternate power input nor PoE
 power 6
 download protocol, HTTP or TFTP 38

E

- earth ground 51
- enable night ring events 33
- ethernet cable 50
- event configuration
 - enable night ring events 33
- expiration time for SIP server lease 24, 27
- export configuration button 18
- export settings 18

F

- factory default settings 13
 - how to set 13
- firmware
 - where to get the latest firmware 45

G

- gang box mounting 51
- get autoprovisioning from DHCP 38
- get autoprovisioning template 38
- get autoprovisioning template button 38
- GMT table 43
- GMT time 43
- green link light 12

H

- home page 17
- http POST command 48
- http web-based configuration 3

I

- identifier names (PST, EDT, IST, MUT) 43
- identifying your product 1
- illustration of device mounting process 49
- import configuration button 18
- import settings 18
- import/export settings 18
- importing and exporting the device's configuration 18
- installation, typical device system 2
- intrusion sensor 28, 29
 - activate relay 29
- IP address 14, 22
- IP addressing 22

- default
 - IP addressing setting 14

J

- J3 terminal block, 16 AWG gauge wire 6

L

- lease, SIP server expiration time 24, 27
- lengthy pages 31
- link LED 50
- link light 12
- local SIP port 24
- log in address 16

M

- MGROUP
 - MGROUP Name 31
- mounting the device 49
- multicast configuration 30
- Multicast IP Address 31

N

- navigation (web page) 15
- navigation table 15
- network configuration 21
- network rate 4
- Network Setup 21
- nightring tones 31
- Nightringer 6, 26, 41, 45
- Nightringer in peer to peer mode (cannot be used) 26
- nightringer settings 27
- Nightringer, SIP registration required 26
- NTP server 38

P

- packet time 3
- pages (lengthy) 31
- part number 4
- parts list 5
- password
 - for SIP server login 24
 - login 17

- restoring the default 14
- port
 - local SIP 24
 - remote SIP 24
- posix timezone string
 - timezone string 38
- POST command 48
- power requirement 4
- priority
 - assigning 31
- product
 - configuring 14
 - mounting 49
 - parts list 5
- product features 3
- product overview
 - product features 3
 - product specifications 4
 - supported protocols 3
 - supported SIP servers 3
 - typical system installation 2
- product specifications 4
- protocols supported 3

R

- reboot 46, 47
- remote SIP port 24
- Reset Test Function Management (RTFM) switch 13
- resetting the IP address to the default 49, 53
- restoring factory default settings 13, 57
- restoring the factory default settings 13
- return and restocking policy 56
- ringtones 31
 - lengthy pages 31
- RMA returned materials authorization 54
- RMA status 54
- rport discovery setting, disabling 25
- RTFM switch 13
- RTP/AVP 3

S

- sales 54
- sensor 29
 - activate relay 29
 - blink strobe 29
 - sensor normally closed 29
- sensor setup page 28
- sensor setup parameters 28
- sensors 29
- server address, SIP 24

- service 54
 - set the time from the NTP server 38
 - set time with external NTP server on boot 38
 - setting up the device 6
 - settings, default 13
- SIP
 - enable SIP operation 24
 - local SIP port 24
 - user ID 24
- SIP (session initiation protocol) 3
- SIP configuration 23
 - SIP Server 24
- SIP configuration parameters
 - outbound proxy 24, 27
 - registration and expiration, SIP server lease 24, 27
 - user ID, SIP 24
- SIP registration 24
- SIP remote SIP port 24
- SIP server 24
 - password for login 24
 - SIP servers supported 3
 - user ID for login 24
- Spare in the Air Policy 56
- SRST 24
- static IP addressing 22
- status LED 50
- subnet mask 14, 22
- supported protocols 3

T

- tech support 54
- technical support, contact information 54
- terminal block, 16 AWG gauge wire 6
- time zone string examples 43

U

- user ID
 - for SIP server login 24
- username
 - changing for web configuration access 19
 - default for web configuration access 17
 - restoring the default 14

V

- VLAN ID 22
- VLAN Priority 22
- VLAN tagging support 22
- VLAN tags 22

W

- warranty 55
- warranty & RMA returns outside of the United States 55
- warranty & RMA returns within the United States 55
- warranty and RMA returns page 56
- warranty policy at CyberData 55
- web access password 14
- web access username 14
- web configuration log in address 16
- web page
 - navigation 15
- web page navigation 15
- web-based configuration 14
- weight 4
- wget, free unix utility 48

Y

- yellow act light 12