

CyberData

The IP Endpoint Company



*VoIP V2 Loudspeaker
Amplifier (AC-Powered)
Operations Guide*

Part #011095

Document Part #930360L
for Firmware Version 6.2.0

CyberData Corporation
3 Justin Court
Monterey, CA 93940
(831) 373-2601

VoIP V2 Paging Amplifier Operations Guide 930360L
Part # 011095

COPYRIGHT NOTICE:

© 2014, CyberData Corporation, ALL RIGHTS RESERVED.

This manual and related materials are the copyrighted property of CyberData Corporation. No part of this manual or related materials may be reproduced or transmitted, in any form or by any means (except for internal use by licensed customers), without prior express written permission of CyberData Corporation. This manual, and the products, software, firmware, and/or hardware described in this manual are the property of CyberData Corporation, provided under the terms of an agreement between CyberData Corporation and recipient of this manual, and their use is subject to that agreement and its terms.

DISCLAIMER: Except as expressly and specifically stated in a written agreement executed by CyberData Corporation, CyberData Corporation makes no representation or warranty, express or implied, including any warranty or merchantability or fitness for any purpose, with respect to this manual or the products, software, firmware, and/or hardware described herein, and CyberData Corporation assumes no liability for damages or claims resulting from any use of this manual or such products, software, firmware, and/or hardware. CyberData Corporation reserves the right to make changes, without notice, to this manual and to any such product, software, firmware, and/or hardware.

OPEN SOURCE STATEMENT: Certain software components included in CyberData products are subject to the GNU General Public License (GPL) and Lesser GNU General Public License (LGPL) “open source” or “free software” licenses. Some of this Open Source Software may be owned by third parties. Open Source Software is not subject to the terms and conditions of the CyberData COPYRIGHT NOTICE or software licenses. Your right to copy, modify, and distribute any Open Source Software is determined by the terms of the GPL, LGPL, or third party, according to who licenses that software.

Software or firmware developed by CyberData that is unrelated to Open Source Software is copyrighted by CyberData, subject to the terms of CyberData licenses, and may not be copied, modified, reverse-engineered, or otherwise altered without explicit written permission from CyberData Corporation.

TRADEMARK NOTICE: CyberData Corporation and the CyberData Corporation logos are trademarks of CyberData Corporation. Other product names, trademarks, and service marks may be the trademarks or registered trademarks of their respective owners.



Technical Support

The fastest way to get technical support for your VoIP product is to submit a VoIP Technical Support form at the following website:
<http://www.cyberdata.net/support/contactsupportvoip.php>

Phone: (831) 373-2601, Ext. 333

Email: support@cyberdata.net

Fax: (831) 373-4193



Company and product information is at www.cyberdata.net.

Revision Information

Revision 930360L, released on April 4, 2014, corresponds to firmware version 6.2.0 and has the following changes:

- Adds the following warning to the following sections:
- [Important Safety Instructions](#)
- [Section 1.2, "Typical System Installation"](#)
- [Section Appendix A:, "Mounting the Amplifier"](#)
- **Warning Text:** "The PoE connector is intended for intra-building connections only and does not route to the outside plant."

Pictorial Alert Icons

	<p>General Alert <i>This pictorial alert indicates a potentially hazardous situation. This alert will be followed by a hazard level heading and more specific information about the hazard.</i></p>
	<p>Ground <i>This pictorial alert indicates the Earth grounding connection point.</i></p>

Hazard Levels

Danger: Indicates an imminently hazardous situation which, if not avoided, will result in death or serious injury. This is limited to the most extreme situations.

Warning: Indicates a potentially hazardous situation which, if not avoided, could result in death or serious injury.



Caution: Indicates a potentially hazardous situation which, if not avoided, could result in minor or moderate injury. It may also alert users against unsafe practices.

Notice: Indicates a statement of company policy (that is, a safety policy or protection of property).

- The safety guidelines for the equipment in this manual do not purport to address all the safety issues of the equipment. It is the responsibility of the user to establish appropriate safety, ergonomic, and health practices and determine the applicability of regulatory limitations prior to use. Potential safety hazards are identified in this manual through the use of words Danger, Warning, and Caution, the specific hazard type, and pictorial alert icons.

Important Safety Instructions

1. Read these instructions.
2. Keep these instructions.
3. Heed all warnings.
4. Follow all instructions.
5. Do not use this apparatus near water.
6. Clean only with dry cloth.
7. Do not block any ventilation openings. Install in accordance with the manufacturer's instructions.
8. Do not install near any heat sources such as radiators, heat registers, stoves, or other apparatus (including amplifiers) that produce heat.
9. Do not defeat the safety purpose of the polarized or grounding-type plug. A polarized plug has two blades with one wider than the other. A grounding type plug has two blades and a third grounding prong. The wide blade or the third prong are provided for your safety. If the provided plug does not fit into your outlet, consult an electrician for replacement of the obsolete outlet.
10. Protect the power cord from being walked on or pinched particularly at plugs, convenience receptacles, and the point where they exit from the apparatus.
11. Only use attachments/accessories specified by the manufacturer.
12. Refer all servicing to qualified service personnel. Servicing is required when the apparatus has been damaged in any way, such as power-supply cord or plug is damaged, liquid has been spilled or objects have fallen into the apparatus, the apparatus has been exposed to rain or moisture, does not operate normally, or has been dropped.
13. Prior to installation, consult local building and electrical code requirements.
- 14. WARNING: The VoIP V2 Loudspeaker Amplifier enclosure is not rated for any AC voltages!**

 <p>GENERAL ALERT</p>	<p>Warning</p> <p><i>Electrical Hazard:</i> This product should be installed by a licensed electrician according to all local electrical and building codes.</p>
 <p>GENERAL ALERT</p>	<p>Warning</p> <p><i>Electrical Hazard:</i> To prevent injury, this apparatus must be securely attached to the floor/wall in accordance with the installation instructions.</p>
 <p>GENERAL ALERT</p>	<p>Warning</p> <p>The PoE connector is intended for intra-building connections only and does not route to the outside plant.</p>

Abbreviations and Terms

Abbreviation or Term	Definition
A-law	A standard companding algorithm, used in European digital communications systems to optimize, i.e., modify, the dynamic range of an analog signal for digitizing.
AVP	Audio Video Profile
Cat 5	TIA/EIA-568-B Category 5
DHCP	Dynamic Host Configuration Protocol
LAN	Local Area Network
LED	Light Emitting Diode
Mbps	Megabits per Second.
NTP	Network Time Protocol
PBX	Private Branch Exchange
PoE	Power over Ethernet (as per IEEE 802.3af standard)
RTFM	Reset Test Function Management
SIP	Session Initiated Protocol
u-law	A companding algorithm, primarily used in the digital telecommunication
UC	Unified Communications
VoIP	Voice over Internet Protocol

Chapter 1 Product Overview	1
1.1 How to Identify This Product	1
1.2 Typical System Installation	2
1.3 Product Features	3
1.4 Supported Protocols	4
1.5 Supported SIP Servers	4
1.6 Product Specifications	5
1.7 Dimensions	6
Chapter 2 Installing the VoIP V2 Loudspeaker Amplifier	7
2.1 Parts List	7
2.2 Loudspeaker Amplifier Setup	8
2.2.1 Loudspeaker Amplifier Components	9
2.2.2 Loudspeaker Amplifier NEMA Box Components	10
2.2.3 Connecting the Loudspeaker Amplifier	11
2.2.4 Loudspeaker Amplifier DIP Switches	13
2.2.5 VoIP V2 Loudspeaker Amplifier System Installation and Connection Options	14
2.2.6 Loudspeaker Amplifier Jumpers	16
2.2.7 Ethernet Connection	16
2.2.8 Loudspeaker Type	17
2.2.9 Cabling/Wiring	17
2.2.10 Confirm Operation	18
2.2.11 Confirm the IP Address and Test the Audio	19
2.2.12 Adjust the Volume	19
2.3 Configure the Loudspeaker Amplifier Parameters	21
2.3.1 Loudspeaker Amplifier Web Page Navigation	22
2.3.2 Log in to the Configuration Home Page	23
2.3.3 Configure the Device Parameters	26
2.3.4 Configure the Network Parameters	29
2.3.5 Configure the SIP Parameters	31
2.3.6 Configure the Nighthringer Parameters	34
2.3.7 Configure the Sensor Configuration Parameters	36
2.3.8 Configure the Multicast Configuration Parameters	38
2.3.9 Configure the Audio Parameters	42
2.3.10 User-created Audio Files	46
2.3.11 Configure the Event Parameters	48
2.3.12 Configure the Autoprovisioning Parameters	53
2.3.13 Upgrading the Firmware	58
2.3.14 Reboot the Loudspeaker Amplifier	61
Appendix A Mounting the Amplifier	63
A.1 Important Safety Instructions	63
A.2 Mount the Amplifier	64
Appendix B Setting up a TFTP Server	66
B.1 Set up a TFTP Server	66
B.1.1 In a LINUX Environment	66
B.1.2 In a Windows Environment	66
Appendix C Troubleshooting/Technical Support	67
C.1 Frequently Asked Questions (FAQ)	67
C.2 Documentation	67
C.3 Contact Information	68
C.4 Warranty	69
C.4.1 Warranty & RMA Returns within the United States	69
C.4.2 Warranty & RMA Returns outside of the United States	69
C.4.3 Spare in the Air Policy	70
C.4.4 Return and Restocking Policy	70
C.4.5 Warranty and RMA Returns Page	70

1 Product Overview

The CyberData SIP-enabled VoIP V2 Loudspeaker Amplifier (AC-Powered) provides an easy method for implementing an IP-based overhead paging system for both new and legacy installations.

With up to 25 watts of driving power (802.3at), the Amplifier provides direct drive of a standard Horn speaker and supports a line-out connector for connection to an external amplifier. The interface is compatible with most SIP-based IP PBX servers that comply with the SIP RFC 3261. For non-SIP environments, the Loudspeaker Amplifier can be configured to listen to multicast address and port number combinations to form paging zones.

1.1 How to Identify This Product

To identify the VoIP V2 Loudspeaker Amplifier (AC-Powered), look for a model number label similar to the one shown in [Figure 1-1](#). The model number on the label should be **011095**.

Figure 1-1. Model Number Label

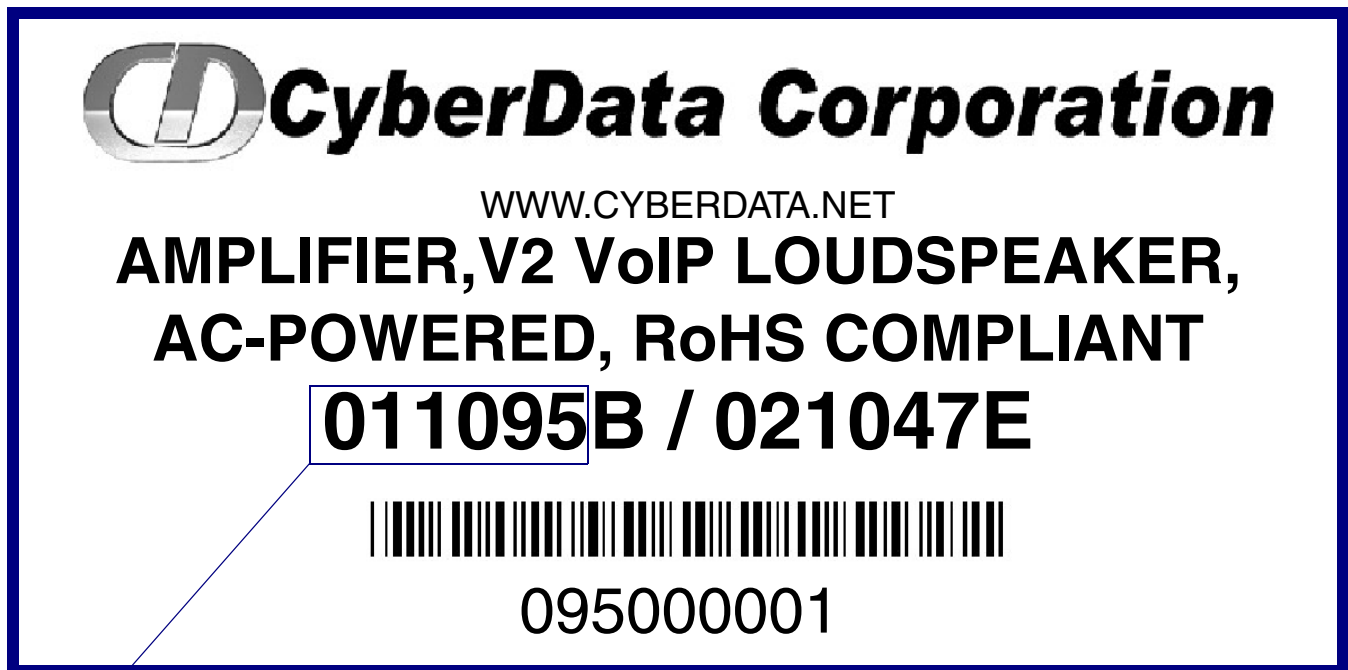





Model number

1.2 Typical System Installation

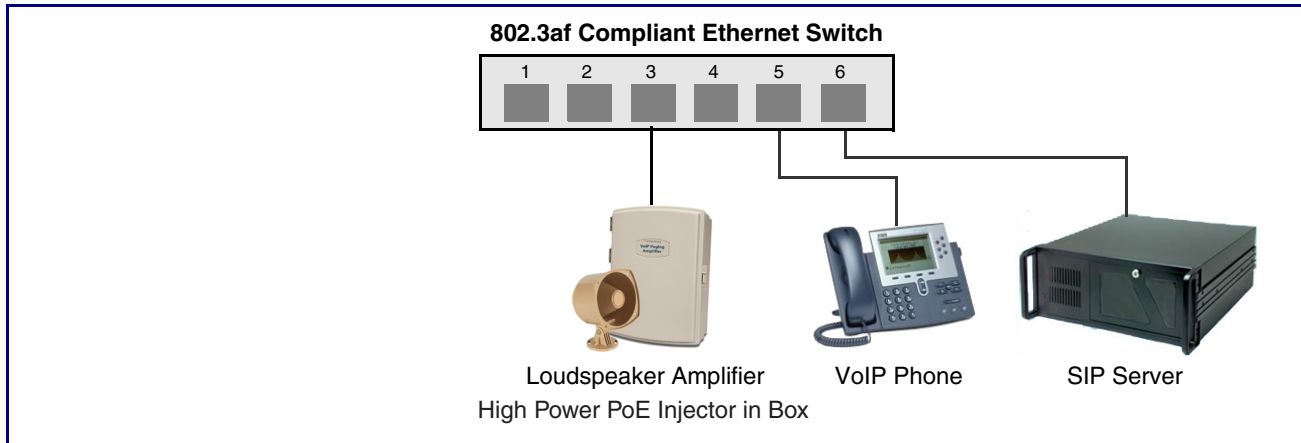
Figure 1-2 illustrates how the VoIP V2 Loudspeaker Amplifier is normally installed as part of a public address system.

Figure 1-2. Typical Installation



 GENERAL ALERT	<p>Warning <i>Electrical Hazard:</i> The VoIP V2 Loudspeaker Amplifier enclosure is not rated for any AC voltages.</p>
 GENERAL ALERT	<p>Warning <i>Electrical Hazard:</i> This product should be installed by a licensed electrician according to all local electrical and building codes.</p>
 GENERAL ALERT	<p>Warning <i>Electrical Hazard:</i> To prevent injury, this apparatus must be securely attached to the floor/wall in accordance with the installation instructions.</p>
 GENERAL ALERT	<p>Warning The PoE connector is intended for intra-building connections only and does not route to the outside plant.</p>

1.3 Product Features

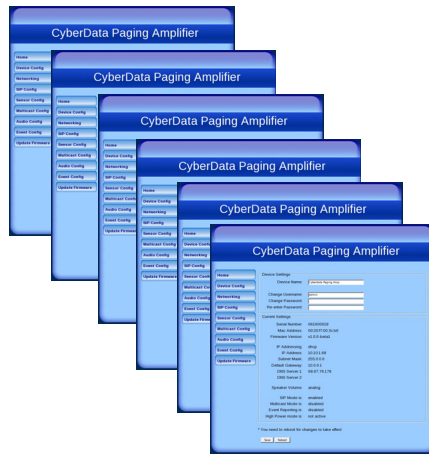

- SIP (RFC 3261) compatible
- Dual-speed ethernet 10/100 Mbps
- Web-based configuration
- Web-based firmware upgradeable
- PoE 802.3at and 802.3af-enabled
- IGMP
- Line-out connector
- DTMF controlled relay with open sense
- Direct speaker drive
- User-uploadable tones
- Simultaneous SIP and Multicast
- Autoprovisioning
- Line-In capability
- Nightringer (can use outbound proxy)
- Weather-resistant NEMA enclosure
- Multiple credentials for registering with multiple SIP servers

1.4 Supported Protocols

The Loudspeaker Amplifier supports:

- SIP
- Multicast
- HTTP Web-based configuration
Provides an intuitive user interface for easy system configuration and verification of Loudspeaker Amplifier operations.
- DHCP Client
Dynamically assigns IP addresses in addition to the option to use static addressing.
- TFTP Client
Facilitates Web-based firmware upgrades of the latest Loudspeaker Amplifier capabilities.
- RTP
- RTP/AVP - Audio Video Profile
- SPEEX
- Audio Encodings
PCMU (G.711 mu-law)
PCMA (G.711 A-law)
Packet Time 20 ms

1.5 Supported SIP Servers

The following link contains information on how to configure the Loudspeaker Amplifier for the supported SIP servers:

<http://www.cyberdata.net/support/server/index.html>

1.6 Product Specifications

Table 1. Product Specifications

Category	Specification
Ethernet I/F	10/100 Mbps
Power Input	PoE 802.3at or 802.3af
Operating Temperature	-10° C to 50° C (14° F to 122° F)
Protocol	SIP RFC 3261
Payload Types	G711, SPEEX
Warranty	2 Years Limited
Dimensions	14" x 10" x 4"
Audio Output	802.3af - up to 10 Watts (default, 50% duty cycle [one second on and one second off]). 802.3at - up to 22 Watts (default, 50% duty cycle [one second on and one second off])
Line In:	
Input Signal Amplitudes	2.0 VPP maximum
Input Impedance	10k Ohm
Line Out:	
Output Signal Amplitudes	2.0 VPP maximum
Output Level	+2dBm nominal
Total Harmonic Distortion	0.5% maximum
Output Impedance	10k Ohm
Part Number	011095

1.7 Dimensions

Figure 1-3. Dimensions

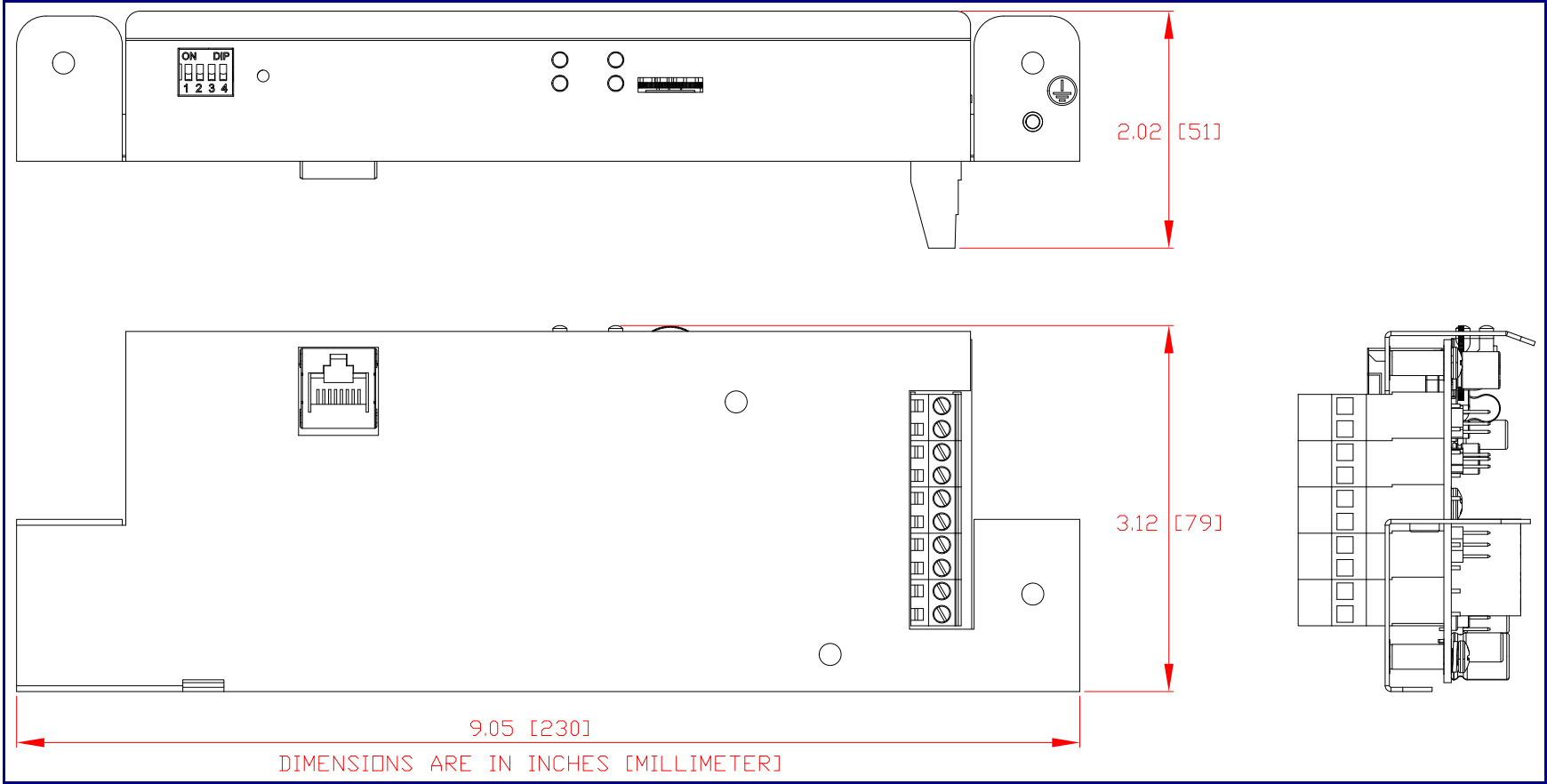



2 Installing the VoIP V2 Loudspeaker Amplifier

2.1 Parts List

Table 2-1 illustrates the parts for each Loudspeaker Amplifier and includes a kit for mounting.

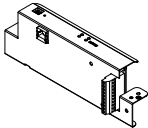
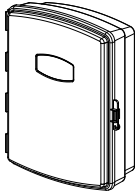
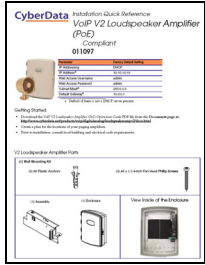
Table 2-1. Parts List

Quantity	Part Name	Illustration
1	Loudspeaker Amplifier Assembly	
1	Enclosure	
1	Installation Quick Reference Guide	
1	Loudspeaker Amplifier Mounting Accessory Kit, RoHS (part #071057A) which includes: (3) Plastic Ribbed Anchors (3) #6 Sheet Metal Screws	

2.2 Loudspeaker Amplifier Setup

Set up and configure each Loudspeaker Amplifier *before* you mount it.

CyberData delivers each Loudspeaker Amplifier with the factory default values indicated in [Table 2-2](#):

Table 2-2. Factory Default Settings—Default of Network

Parameter	Factory Default Setting
IP Addressing	DHCP
IP Address ^a	10.10.10.10
Web Access Username	admin
Web Access Password	admin
Subnet Mask ^a	255.0.0.0
Default Gateway ^a	10.0.0.1

a. Default if there is not a DHCP server present.

2.2.1 Loudspeaker Amplifier Components

Figure 2-4 shows the components of the Loudspeaker Amplifier .

Figure 2-4. Loudspeaker Amplifier Components

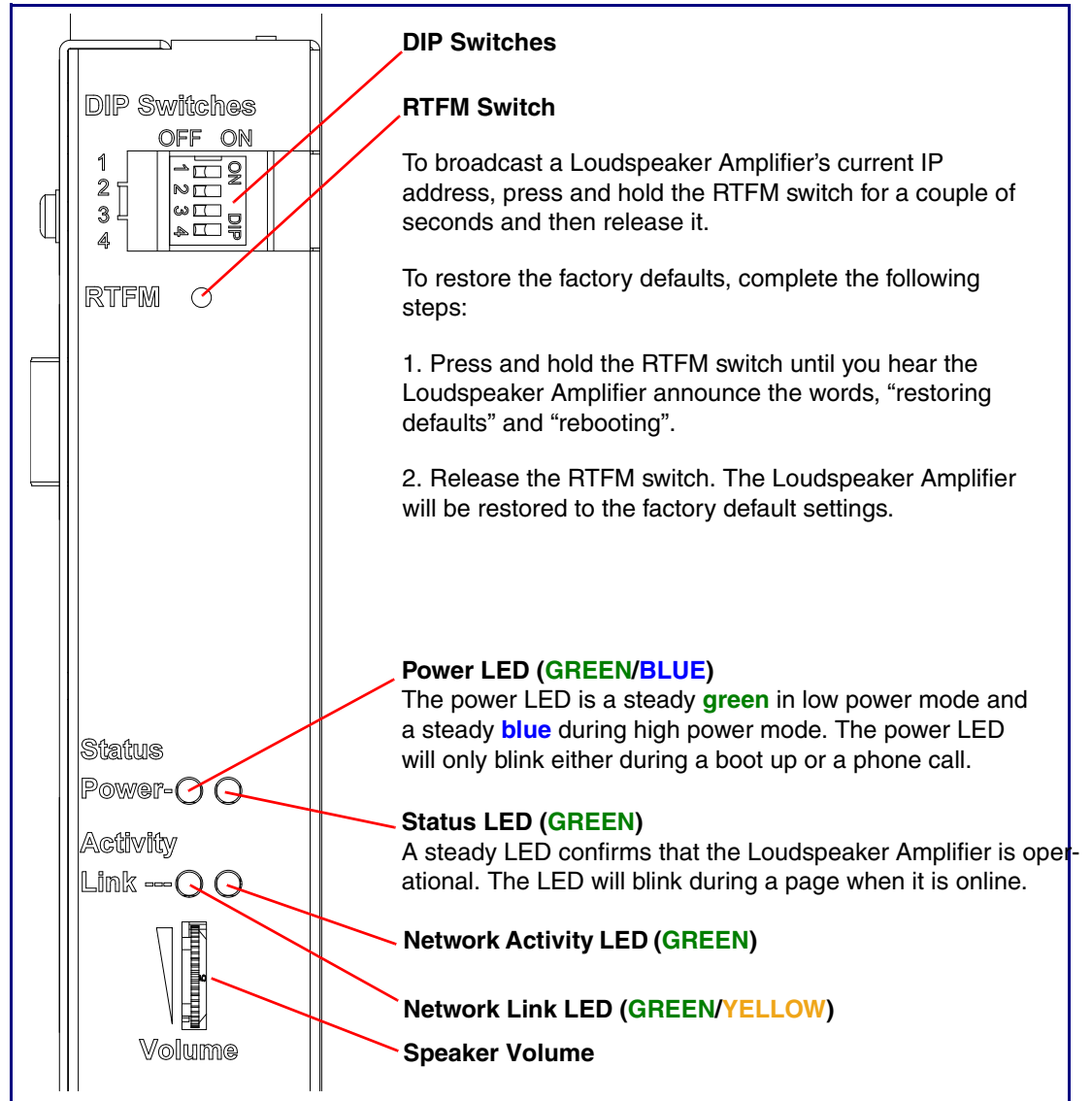

2.2.2 Loudspeaker Amplifier NEMA Box Components

Figure 2-5 shows all of the NEMA box components of the loudspeaker amplifier.

Figure 2-5. Loudspeaker Amplifier Components—AC powered

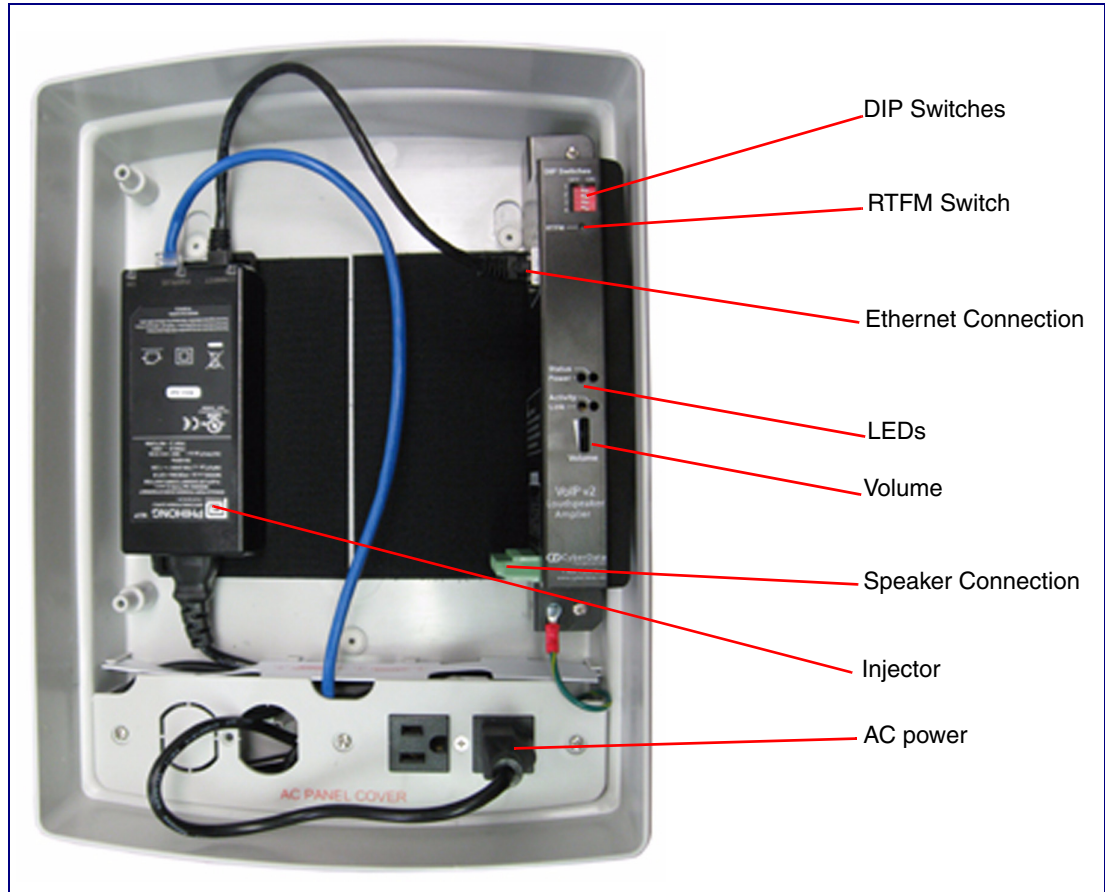

2.2.3 Connecting the Loudspeaker Amplifier

2.2.3.1 Using the Amplified Outputs

Figure 2-6 and Figure 2-7 illustrates how to connect the VoIP V2 Loudspeaker Amplifier and use the amplified outputs in low and high power mode.

Low Power Mode

Figure 2-6. Using the Amplified Outputs—Low Power Mode

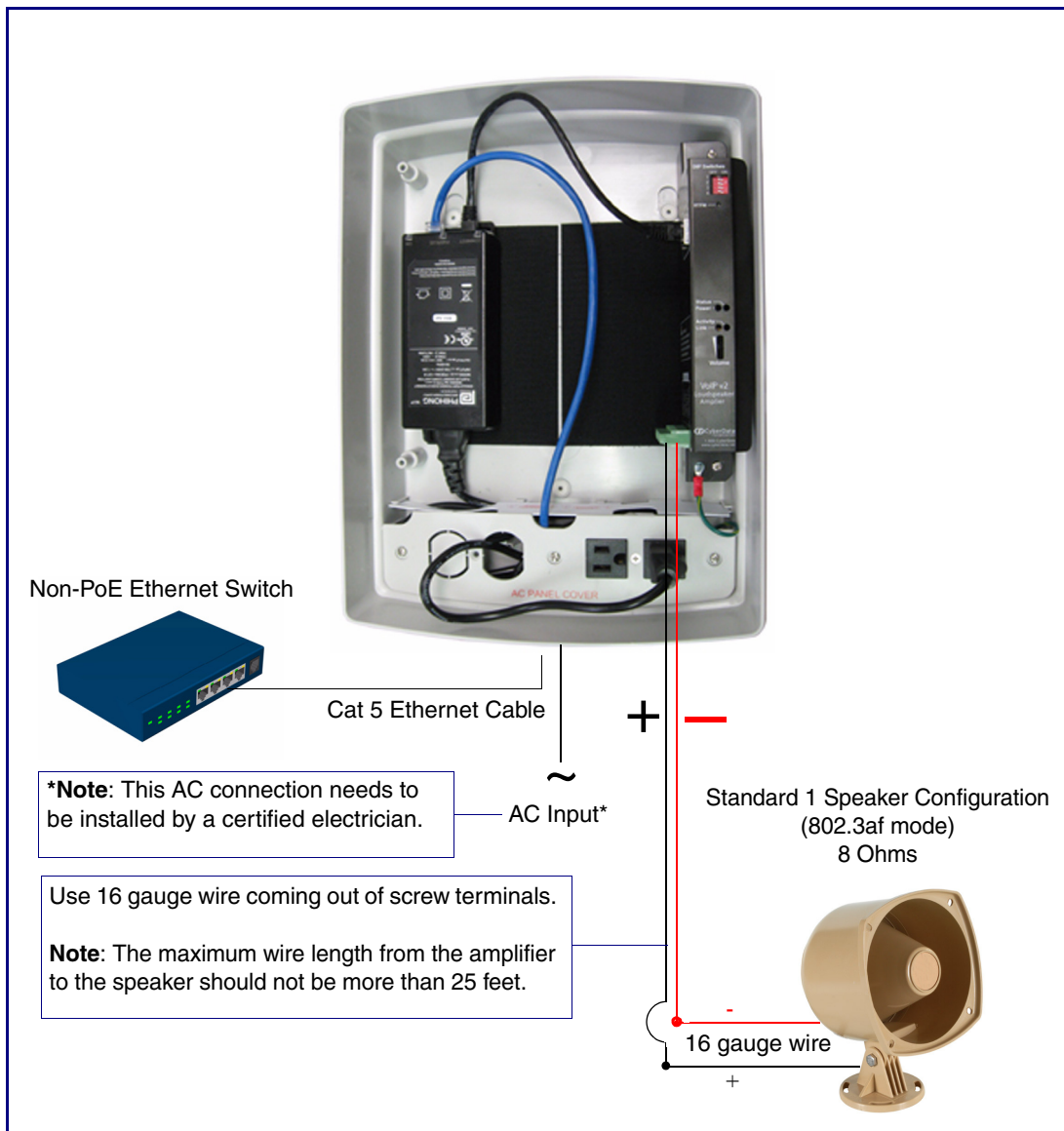

High Power Mode

Figure 2-7. Using the Amplified Outputs—High Power Mode

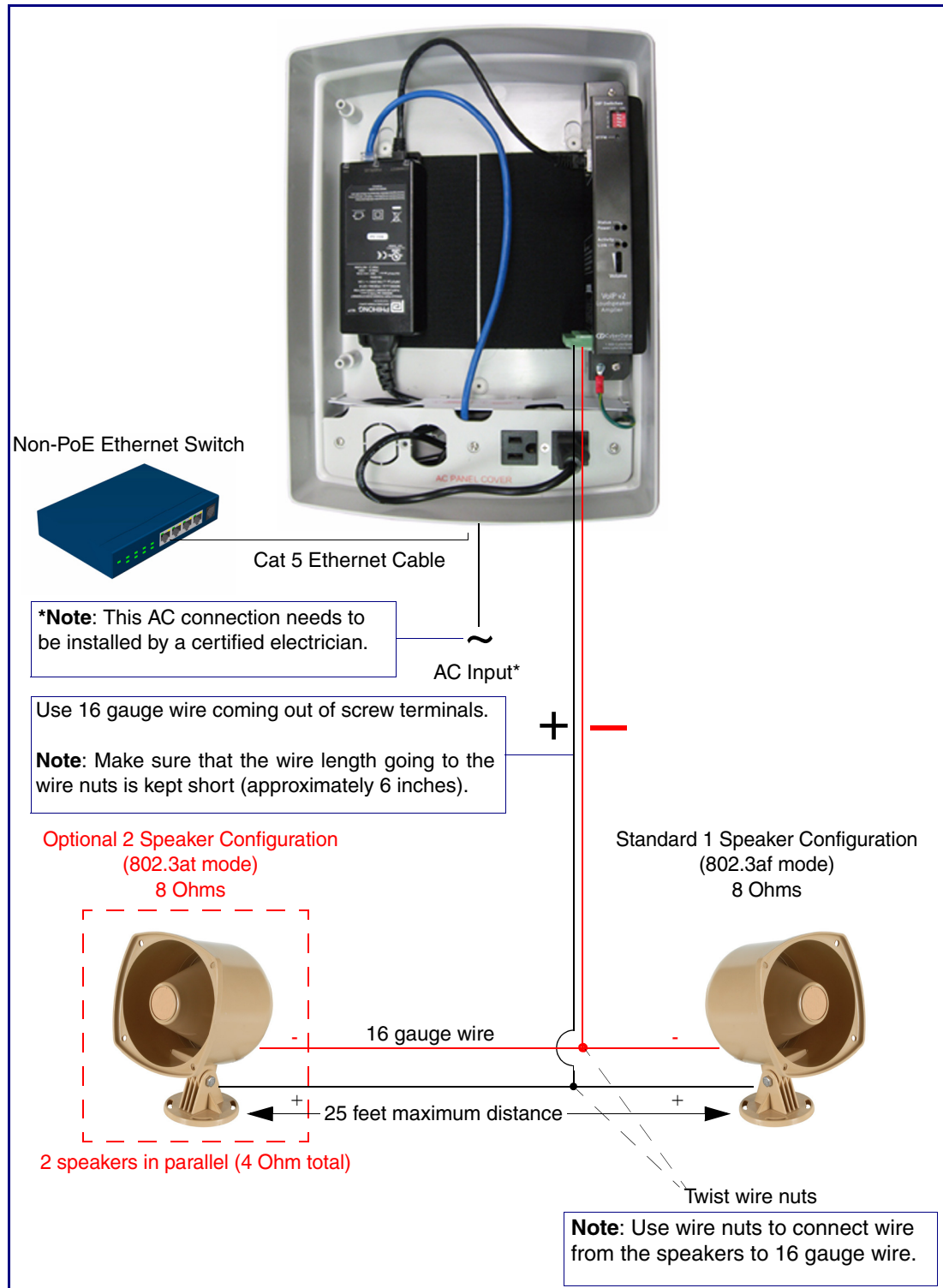

2.2.4 Loudspeaker Amplifier DIP Switches

See [Figure 2-8](#) to identify the DIP Switches.

Figure 2-8. DIP Switches

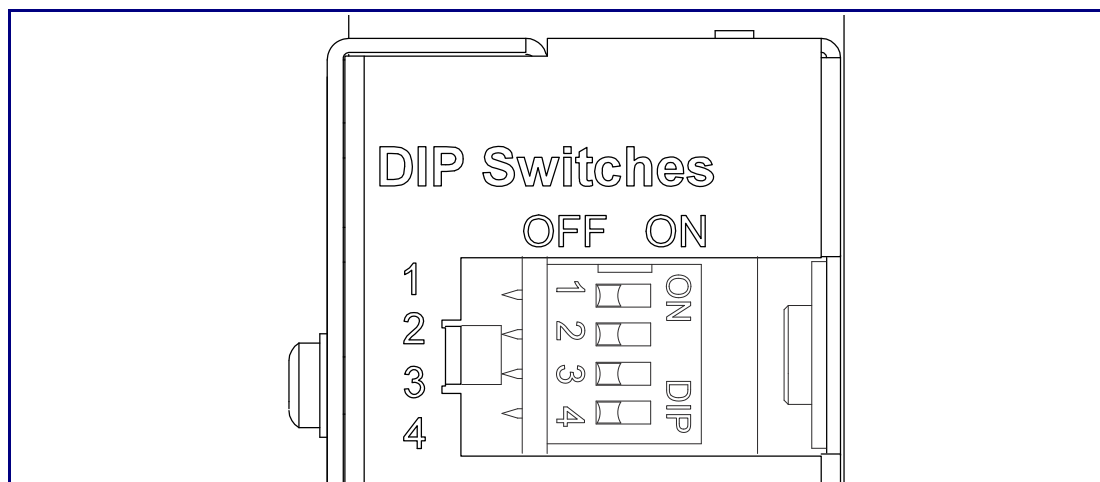

See [Table 2-3](#) and [Table 2-4](#) for the DIP Switch settings.

Table 2-3. DIP Switch Settings—Low Power—802.3af Compliant (Default)

DIP Switch	Setting	Description
1	OFF	Sets PoE for 802.3af class.
2	N/A	Not applicable for power setting.
3	ON	Switch mode current set to LOW .
4	OFF	Low gain amplifier setting.

Table 2-4. DIP Switch Settings—High Power—Non-PoE Compliant^a

DIP Switch	Setting	Description
1	ON	Sets PoE for 802.3af class.
2	N/A	Not applicable for power setting.
3	OFF	Switch mode current set to HIGH .
4	ON	Force high gain amplifier.

a. If set to high power, the unit will not power ON with 802.3af compliant switch. You must use a power injector in this mode (CyberData part number 010867A).

Table 2-5. DIP Switch 2 Settings

DIP Switch	Setting	Description
2	OFF	Manual Vol. The speaker volume is set manually by the analog volume trimmer.
2	ON	Bypass. Bypasses the manual volume control of the analog volume trimmer and uses the web page volume settings.

2.2.5 VoIP V2 Loudspeaker Amplifier System Installation and Connection Options

The following figures show the connection options for the VoIP V2 Loudspeaker Amplifier.

Figure 2-9. Loudspeaker Amplifier Connections

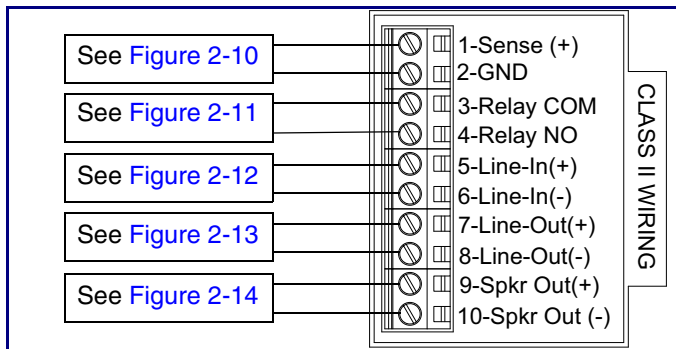

Figure 2-10. Sensor Connection

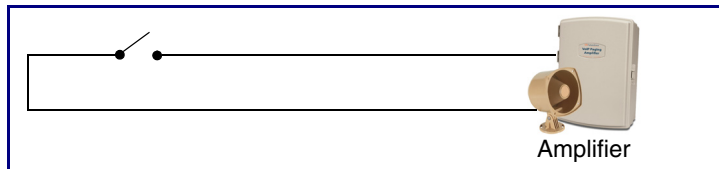

Figure 2-11. Relay or Strobe Alert Connection

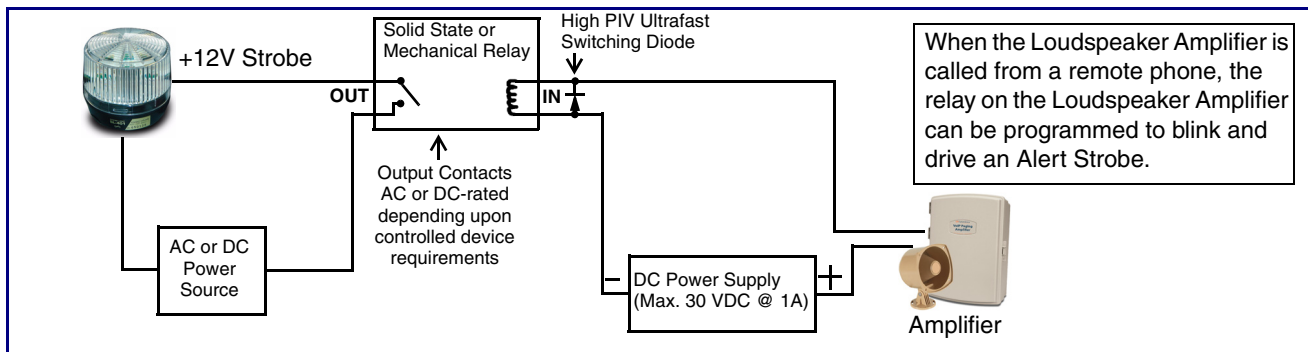

Figure 2-12. Line-In Connection

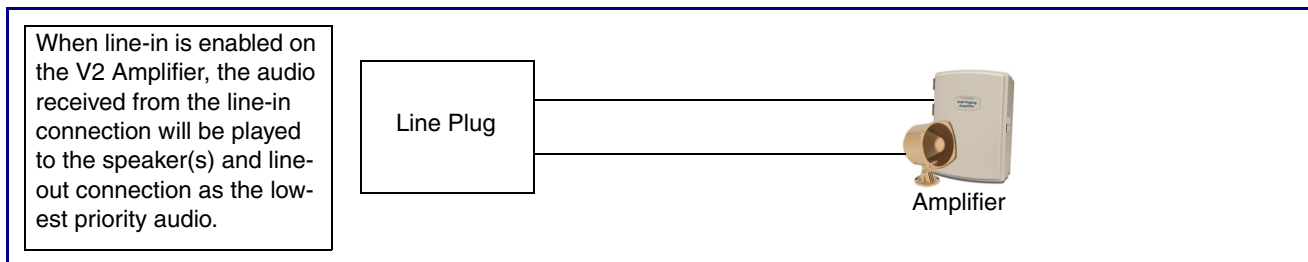

Figure 2-13. Line Out Connection

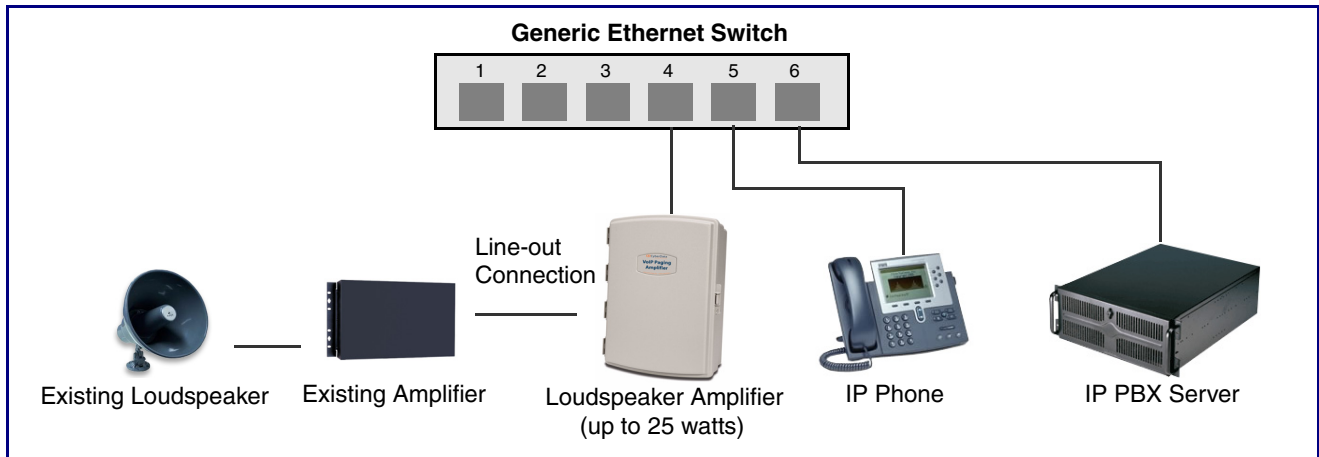
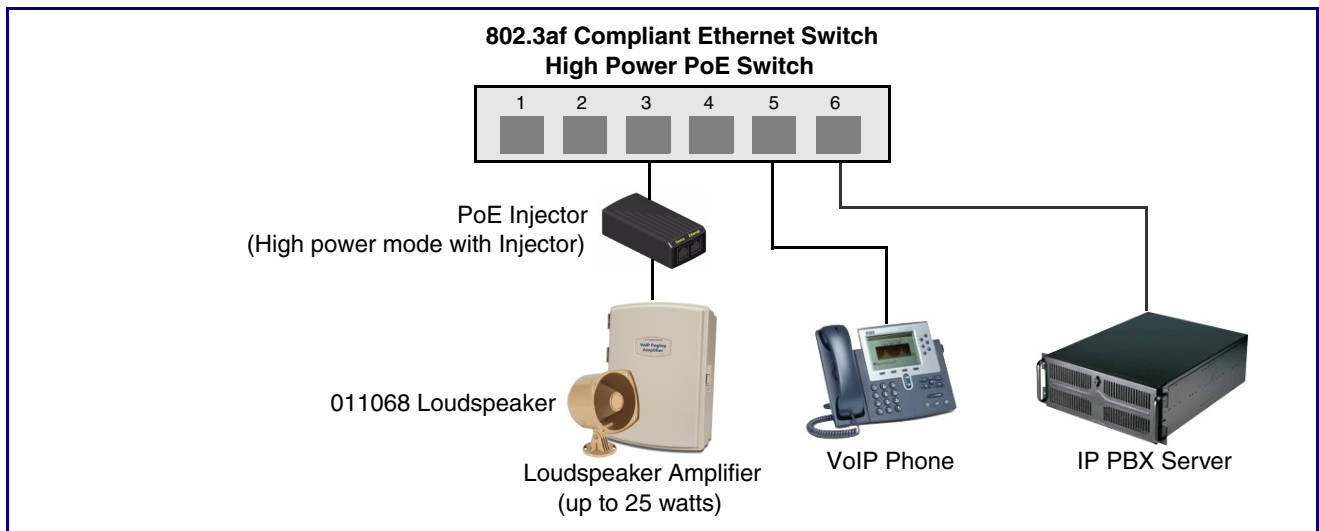

Figure 2-14. Speaker Out Connection



2.2.6 Loudspeaker Amplifier Jumpers

See [Figure 2-15](#) for the jumper locations.

Figure 2-15. Jumper Locations

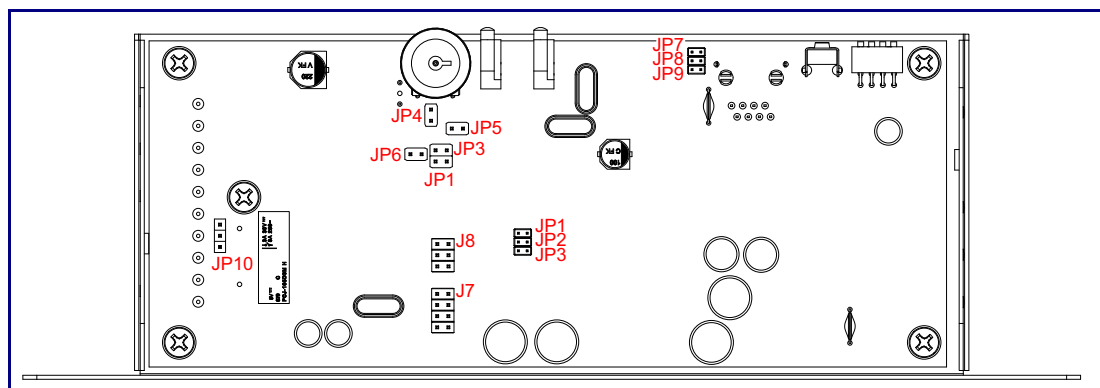

See [Table 2-6](#) for the jumper descriptions.

Table 2-6. Jumper Descriptions

Jumper	Description
JP1	Factory Only—Not Used
JP2	Factory Only—Not Used
JP3	Factory Only—Not Used
JP4	Manual Reset—Not Used
JP5	Watch Dog Timer Enable—Not Used
JP6	Audio Enable—Factory Only
JP7	Factory Only—Not Used
JP8	Factory Only—Not Used
JP9	Factory Only—Not Used
JP10	Relay Connection Option—Wire link in position-A.
J7	JTAG Interference—Factory Only
J8	Console Port—Factory Only

2.2.7 Ethernet Connection

See [Table 2-7](#) for details about the Loudspeaker Amplifier connection.

Table 2-7. Loudspeaker Amplifier Connection

Connection	Connection Details	Location
Ethernet	Use a RJ 45 cable.	VoIP V2 Loudspeaker Amplifier

2.2.8 Loudspeaker Type

Using the amplified output, the CyberData VoIP V2 Loudspeaker Amplifier supports the 011068 Loudspeaker or equivalent unamplified loudspeaker.

Figure 2-16. 011068 Loudspeaker



2.2.9 Cabling/Wiring

Using the amplified output, you may connect a 011068 loudspeaker or equivalent unamplified speaker to a Loudspeaker Amplifier with good quality speaker wire that is 16 gauge and limited to 25 feet in length.

2.2.10 Confirm Operation

After connecting the Loudspeaker Amplifier to the ethernet hub, use the LEDs on the Loudspeaker Amplifier face to confirm that the Loudspeaker Amplifier is operational and linked to the network.

Table 2-8. Loudspeaker Amplifier LEDs

LED	Color	Function
Power	Blue/Green	The power LED is illuminated a steady green when the power is on and in low power mode. The power LED is illuminated a steady blue when the amplifier is in high power mode. The power LED will blink during a boot up or a phone call.
Status	Green	After supplying power to the Loudspeaker Amplifier, a steady LED confirms that the Loudspeaker Amplifier is operational. The status LED will blink during a page when it is online.
Link	Green/Yellow	The Link LED is illuminated green for a 10Mb link or yellow/green for a 100Mb link when the network link to the Loudspeaker Amplifier is established.
Activity	Green	The Activity LED blinks to indicate network traffic.

Figure 2-17. Loudspeaker Amplifier LEDs—Power and Link

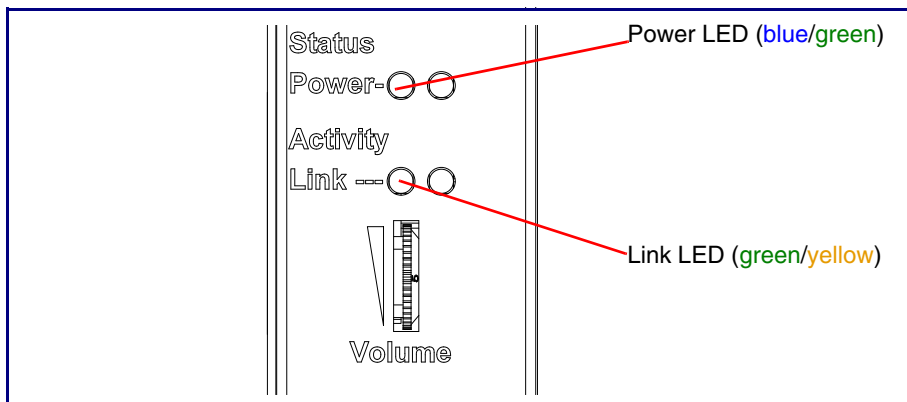
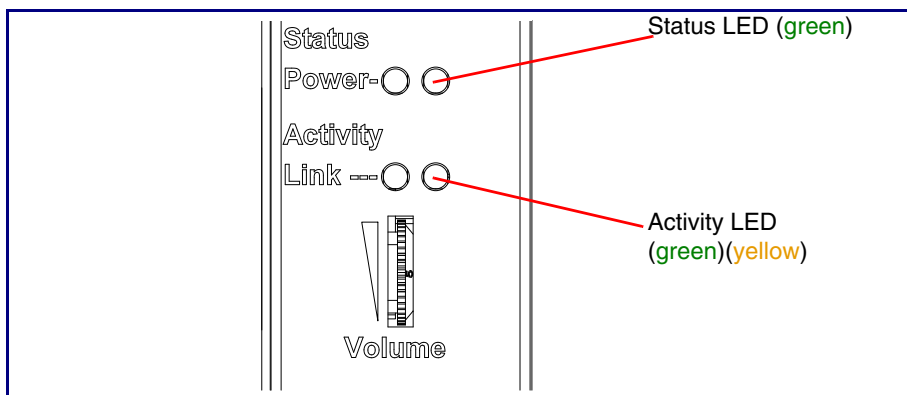

Figure 2-18. Loudspeaker Amplifier LEDs—Status and Activity



2.2.11 Confirm the IP Address and Test the Audio

2.2.11.1 RTFM Switch

When the Loudspeaker Amplifier is operational and linked to the network, use the Reset Test Function Management (**RTFM**) switch (Figure 2-19) on the Loudspeaker Amplifier face to announce and confirm the Loudspeaker Amplifier's IP Address and test the audio to verify that it is working.

Figure 2-19. RTFM Switch

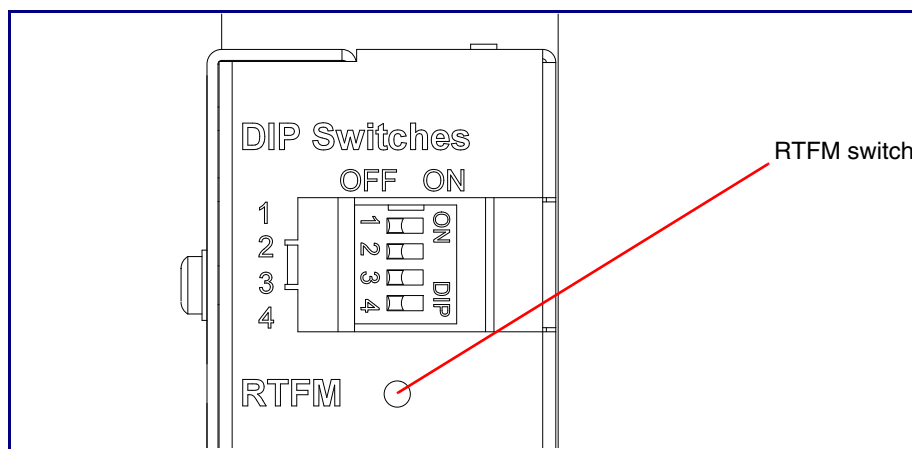

Announcing the IP Address To announce a Loudspeaker Amplifier's current IP address:

- Press and hold the RTFM switch for a couple of seconds and then release it.



Caution

Equipment Caution: Pressing and holding the RTFM switch for more than five seconds will restore the V2 Paging Amplifier to the factory default settings. See the “[Restoring the Factory Default Settings](#)” section.

Restoring the Factory Default Settings

To restore the factory default settings, complete the following steps:

1. Press and hold the RTFM switch until you hear the Paging Amplifier announce the words, “restoring defaults” and “rebooting”.
2. Release the RTFM switch. The Paging Amplifier will be restored to the factory default settings.

2.2.12 Adjust the Volume

There are two ways to adjust the volume for the Loudspeaker Amplifier:

- The **Speaker Volume (0-9)** setting on the **Device Configuration** page
- The external **Volume** dial on the Loudspeaker Amplifier face

2.2.12.1 The “Speaker Volume (0-9)” Setting

To adjust the Loudspeaker Amplifier volume with the **Speaker Volume (0-9)** setting on the **Device Configuration** page, complete the following steps:

1. Make sure that dip switch 2 is set to **ON**.
2. Go to the Loudspeaker Amplifier **Home** page.
3. Select the **Device Configuration** page.
4. In the **Speaker Volume (0-9)** box, type a number between **0** (lowest) and **9** (highest).
5. Select **Save**.
6. Select **Reboot**.

2.2.12.2 The “Line-In Volume (0-9)” Setting

To adjust the Loudspeaker Amplifier volume with the **Line-In Playback Volume (0-9)** setting on the **Device Configuration** page, complete the following steps:

1. Make sure that dip switch 2 is set to **ON**.
2. Go to the Loudspeaker Amplifier **Home** page.
3. Select the **Device Configuration** page.
4. In the **Line-In Playback Volume (0-9)** box, type a number between **0** (lowest) and **9** (highest).
5. Select **Save**.
6. Select **Reboot**.

2.2.12.3 External Volume Dial

To adjust the Loudspeaker Amplifier volume with the external volume dial, complete the following steps:

1. Make sure that dip switch 2 is set to **OFF**.
2. Turn the external **Volume** dial (Figure 2-20) on the Loudspeaker Amplifier face.

Note For the lineout volume, the volume is fixed and the volume control is adjusted through an external amplifier.

Figure 2-20. External Volume Dial

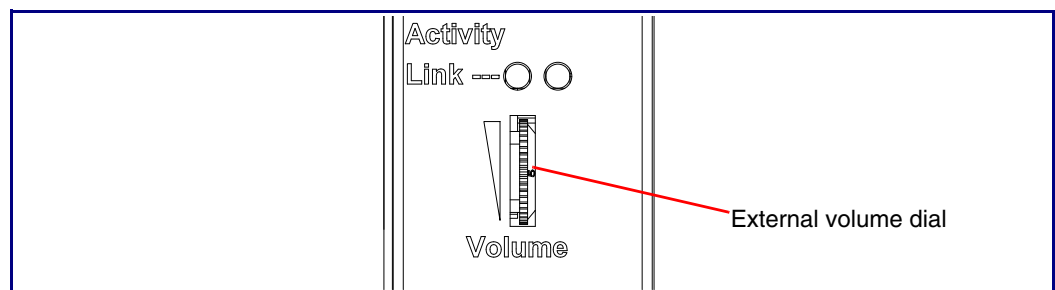

2.3 Configure the Loudspeaker Amplifier Parameters

To configure the Loudspeaker Amplifier online, use a standard web browser.

Configure each Loudspeaker Amplifier and verify its operation *before* you mount it. When you are ready to mount a Loudspeaker Amplifier enclosure, refer to [Appendix A, "Mounting the Amplifier"](#) for instructions.

All Loudspeaker Amplifier are initially configured with the default IP settings indicated in [Table 2-9](#).

When configuring more than one Loudspeaker Amplifier, attach the Loudspeaker Amplifiers to the network one at a time to avoid IP address conflicts.

Table 2-9. Factory Default Settings











Parameter	Factory Default Setting
IP Addressing	DHCP
IP Address ^a	10.10.10.10
Web Access Username	admin
Web Access Password	admin
Subnet Mask ^a	255.0.0.0
Default Gateway ^a	10.0.0.1

a. Default if there is not a DHCP server present.

2.3.1 Loudspeaker Amplifier Web Page Navigation

Table 2-10 shows the navigation buttons that you will see on every Loudspeaker Amplifier web page.

Table 2-10. Loudspeaker Amplifier Web Page Navigation

Web Page Item	Description
	Link to the Home page.
	Link to the Device Configuration page.
	Link to the Networking page.
	Link to the SIP Configuration page.
	Link to the Nightringer page.
	Link to the Sensor Configuration page.
	Link to the Multicast Configuration page.
	Link to the Audio Configuration page.
	Link to the Event Configuration page.
	Link to the Autoprovisioning Configuration page.
	Link to the Update Firmware page.

2.3.2 Log in to the Configuration Home Page

1. Open your browser to the Loudspeaker Amplifier IP address.

Note If the network does not have access to a DHCP server, the device will default to an IP address of 10.10.10.10.

Note Make sure that the PC is on the same IP network as the Loudspeaker Amplifier.

Note You may also download CyberData's VoIP Discovery Utility program which allows you to easily find and configure the default web address of the CyberData VoIP products.

CyberData's VoIP Discovery Utility program is available on the VoIP V2 Loudspeaker Amplifier product page at:

http://www.cyberdata.net/support/voip/discovery_utility.html

The Loudspeaker Amplifier ships in DHCP mode. To get to the **Home** page, use the discovery utility to scan for the device on the network and open your browser from there.

- When prompted, use the following default **Web Access Username** and **Web Access Password** to access the **Home Page** (Figure 2-21):

Web Access Username: **admin**

Web Access Password: **admin**



Figure 2-21. Home Page

The screenshot shows the 'Home Page' of the CyberData Paging Amplifier configuration interface. The page has a blue header with the title 'CyberData Paging Amplifier'. On the left side, there is a vertical menu with buttons for: Home, Device Config, Networking, SIP Config, Nightringer, Sensor Config, Multicast Config, Audio Config, Event Config, Autoprovisioning, and Update Firmware. The main content area is divided into two sections: 'Device Settings' and 'Current Settings'. The 'Device Settings' section contains three input fields: 'Device Name' (pre-filled with 'CyberData Paging Amp'), 'Change Username' (pre-filled with 'admin'), and 'Change Password' (empty). Below these is a 'Re-enter Password' field. The 'Current Settings' section displays various parameters: Serial Number (666000666), Mac Address (00:20:f7:01:90:4e), Firmware Version (v6.2.0), IP Addressing (dhcp), IP Address (10.10.1.206), Subnet Mask (255.0.0.0), Default Gateway (10.0.0.1), DNS Server 1 (8.8.8.8), and DNS Server 2 (empty). Below these are Speaker Volume (4 (digital)), High Power mode (not active), SIP Mode (enabled), Multicast Mode (disabled), Event Reporting (disabled), and Nightringer (enabled (Registered with SIP Server)). At the bottom, there are Primary SIP Server, Backup Server 1, and Backup Server 2, all showing '(Registered with SIP Server)'. A note at the bottom states '* You need to reboot for changes to take effect'. At the very bottom are 'Save' and 'Reboot' buttons.

Section	Parameter	Value
Device Settings	Device Name	CyberData Paging Amp
	Change Username	admin
	Change Password	
Current Settings	Serial Number	666000666
	Mac Address	00:20:f7:01:90:4e
	Firmware Version	v6.2.0
	IP Addressing	dhcp
	IP Address	10.10.1.206
	Subnet Mask	255.0.0.0
	Default Gateway	10.0.0.1
	DNS Server 1	8.8.8.8
	DNS Server 2	
	Speaker Volume	4 (digital)
	High Power mode is	not active
	SIP Mode is	enabled
	Multicast Mode is	disabled
	Event Reporting is	disabled
Nightringer is	enabled (Registered with SIP Server)	
Primary SIP Server	(Registered with SIP Server)	
Backup Server 1	(Registered with SIP Server)	
Backup Server 2	(Registered with SIP Server)	

3. On the **Home Page**, review the setup details and navigation buttons described in [Table 2-11](#).

Table 2-11. Home Page Overview

Web Page Item	Description
Device Settings	
Device Name	Shows the device name (25 character limit).
Change Username	Type in this field to change the username (25 character limit).
Change Password	Type in this field to change the password (19 character limit).
Re-enter Password	Type the password again in this field to confirm the new password (19 character limit).
Current Settings	
Serial Number	Shows the device serial number.
Mac Address	Shows the device Mac address.
Firmware Version	Shows the current firmware version.
IP Addressing	Shows the current IP addressing setting (DHCP or Static).
IP Address	Shows the current IP address.
Subnet Mask	Shows the current subnet mask address.
Default Gateway	Shows the current default gateway address.
DNS Server 1	Shows the current DNS Server 1 address.
DNS Server 2	Shows the current DNS Server 2 address.
Speaker Volume	Shows the current Loudspeaker Amplifier volume mode: Digital (web page) or Analog (volume knob).
High Power Mode is	Shows the current status of High Power mode.
SIP Mode is	Shows the current status of the SIP Mode.
Multicast Mode is	Shows the current status of the Multicast Mode.
Event Reporting is	Shows the current status of the Event Reporting.
Nightringer is	Shows the current status of the Nightringer.
Primary SIP Server	Shows the current status of the Primary SIP Server.
Backup Server 1	Shows the current status of Backup Server 1.
Backup Server 2	Shows the current status of Backup Server 2.
	Click the Save button to save your configuration settings. Note: You need to reboot for changes to take effect.
	Click on the Reboot button to reboot the system.

2.3.3 Configure the Device Parameters

1. Click the **Device Configuration** button to open the **Device Configuration** page. See [Figure 2-22](#).

Figure 2-22. Device Configuration Page

CyberData Paging Amplifier

Device Configuration

Home
Device Config
Networking
SIP Config
Nightringer
Sensor Config
Multicast Config
Audio Config
Event Config
Autoprovisioning
Update Firmware

Volume Settings

Speaker Volume: digital
Speaker Volume (0-9): 4
Line In Playback Volume (0-9): 4

Relay Settings

Activate Relay with DTMF code:
DTMF Activation Code: 321
DTMF Activation Duration (in seconds): 2

Activate Relay During Ring:
Activate Relay During Night Ring:
Activate Relay While Call Active:

Miscellaneous Settings

Two Speakers Connected:
Beep on Initialization:
Auto-Answer Incoming Calls:
Play Ringback Tone:
Enable Line-in Playback:

* You need to reboot for changes to take effect

Save Test Audio Test Relay Reboot

2. On the **Device Configuration** page, you may enter values for the parameters indicated in [Table 2-12](#).

Table 2-12. Device Configuration Parameters





Web Page Item	Description
Volume Settings	
Speaker Volume	Shows the current speaker volume mode (Analog or Digital)
Speaker Volume (0-9)	Type the desired Loudspeaker Amplifier volume level into this field (range is 0 - 9).
Line-In Playback Volume (0-9)	Type the desired line-in playback volume level into this field (range is 0 - 9).
Relay Settings	
Activate Relay with DTMF Code	When selected, the relay can be activated with a DTMF code.
DTMF Activation Code	Type the desired DTMF activation code (25 character limit).
DTMF Activation Duration (in seconds)	Type the desired DTMF activation duration (in seconds) (1 character limit).
Activate Relay During Ring	When selected, the relay will be activated for as long as the phone is ringing. NOTE: When the phone is set to Auto Answer , it will not ring and this option does nothing.
Activate Relay During Night Ring	When selected, the relay will be activated for as long as a night ring tone is playing.
Activate Relay While Call Active	When selected, the relay will be activated for as long as the call is active.
Miscellaneous Settings	
Two Speakers Connected	Select this option if two speakers are connected to the Loudspeaker Amplifier.
Beep on Initialization	When selected, you will hear a beep when the Loudspeaker Amplifier initializes.
Auto-Answer Incoming Calls	When selected, the Loudspeaker Amplifier automatically answers incoming calls.
Play Ringback Tone	Check this box to enable the device to play a ringtone while the remote device is ringing.
Enable Line In Playback	When selected, whatever audio source that you have selected (mp3 player, internet stream, etc.) will be played. Note: The line in audio will be treated as low priority audio that will only play if there is no other audio playing. When higher priority audio is playing, the line in audio will be muted.
	Click the Save button to save your configuration settings. Note: You need to reboot for changes to take effect.
	Click on the Test Audio button to do an audio test. Generates a voice message for testing the device audio quality and volume. It plays the audio at the volume you have configured the paging amp for Note: If the test audio button is pressed while music is playing via the Enabled Line In feature, the music will be muted during the test audio message.

Table 2-12. Device Configuration Parameters (continued)

Web Page Item	Description
	Click on the Test Relay button to do a relay test.
	Click on the Reboot button to reboot the system.

3. After changing the parameters, click the **Save** button.

2.3.4 Configure the Network Parameters

1. Click the **Networking** button to open the **Network Configuration** page (Figure 2-23).

Figure 2-23. Network Configuration Page

CyberData Paging Amplifier

Network Configuration

Home
Device Config
Networking
SIP Config
Nightringer
Sensor Config
Multicast Config
Audio Config
Event Config
Autoprovisioning
Update Firmware

Stored Network Settings

IP Addressing: Static DHCP
IP Address: 10.10.10.10
Subnet Mask: 255.0.0.0
Default Gateway: 10.0.0.1
DNS Server 1: 10.0.0.1
DNS Server 2: 10.0.0.1

Current Network Settings



IP Address: 10.10.1.206
Subnet Mask: 255.0.0.0
Default Gateway: 10.0.0.1
DNS Server 1: 8.8.8.8
DNS Server 2:

* You need to reboot for changes to take effect

Save Reboot

2. On the **Network Configuration** page, enter values for the parameters indicated in [Table 2-13](#).

Table 2-13. Network Configuration Parameters

Web Page Item	Description
Stored Network Settings	
IP Addressing*	Select either DHCP IP Addressing or Static IP Addressing by marking the appropriate radio button. If you select Static , configure the remaining parameters indicated in Table 2-13 . If you select DHCP , go to Step 3 .
IP Address*	Enter the Static IP address.
Subnet Mask	Enter the Subnet Mask address.
Default Gateway	Enter the Default Gateway address.
DNS Server 1*	Enter the DNS Server 1 address.
DNS Server 2*	Enter the DNS Server 2 address.
Current Network Settings	
IP Address	Shows the current IP address.
Subnet Mask	Shows the current Subnet Mask address.
Default Gateway	Shows the current Default Gateway address.
DNS Server 1	Shows the current DNS Server 1 address.
DNS Server 2	Shows the current DNS Server 2 address.
	Click the Save button to save your configuration settings. Note: You need to reboot for changes to take effect.
	Click on the Reboot button to reboot the system.

3. After changing the parameters, click **Save Settings**. This updates the changed parameters. The Loudspeaker Amplifier must be rebooted for changes to take effect.
4. Connect the Loudspeaker Amplifier to the target network.
5. From a system on the same network as the Loudspeaker Amplifier, open a browser with the new IP address of the Loudspeaker Amplifier.

2.3.5 Configure the SIP Parameters

1. Click **SIP Config** to open the **SIP Configuration** page (Figure 2-24).

Note For specific server configurations, go to the **IP-PBX Server Compatibility** page at:
<http://www.cyberdata.net/support/server/index.html>

Figure 2-24. SIP Configuration Page

CyberData Paging Amplifier

SIP Configuration

Enable SIP operation: (Registered with SIP Server)

SIP Settings

Primary SIP Server: 10.0.1.17
Primary SIP User ID: 200
Primary SIP Auth ID: 200
Primary SIP Auth Password: ext200

Backup SIP Server 1: 10.0.1.24
Backup SIP User ID 1: 300
Backup SIP Auth ID 1: 300
Backup SIP Auth Password 1: ext300

Backup SIP Server 2: 10.0.1.6
Backup SIP User ID 2: 303
Backup SIP Auth ID 2: 303
Backup SIP Auth Password 2: ext303

Remote SIP Port: 5060
Local SIP Port: 5060
Outbound Proxy:
Outbound Proxy Port: 0

Register with a SIP Server:
Re-registration Interval (in seconds): 360

Unregister on Reboot:
Buffer SIP Calls:
Beep before Page:

RTP Settings

RTP Port (even): 10500

* You need to reboot for changes to take effect

Save Reboot

2. On the **SIP Configuration** page, you may enter values for the parameters indicated in [Table 2-14](#).

Table 2-14. SIP Configuration Parameters

Web Page Item	Description
Enable SIP Operation	Enables or disables SIP operation.
SIP Settings	
Primary SIP Server	Use this field to set the address of the Primary SIP Server (in dotted decimal notation or as a canonical name). This field can accept canonical names of up to 255 characters in length.
Primary SIP User ID	Type the SIP User ID of the Primary SIP Server (up to 25 alphanumeric characters).
Primary Authenticate ID	Type the Authenticate ID of the Primary SIP Server (up to 25 alphanumeric characters).
Primary Authenticate Password	Type the Authenticate Password of the Primary SIP Server (up to 25 alphanumeric characters).
Backup SIP Server 1 Backup SIP Server 2	<ul style="list-style-type: none"> • If all of the Primary SIP Server and Backup SIP Server fields are populated, the device will attempt to stay registered with all three servers all of the time. You can leave the Backup SIP Server 1 and Backup SIP Server 2 fields blank if they are not needed. • In the event of a registration failure on the Primary SIP Server, the device will use the next highest priority server for outbound calls (Backup SIP Server 1). If Backup SIP Server 1 fails, the device will use Backup SIP Server 2. • If a higher priority SIP Server comes back online, the device will switch back to this server.
Backup SIP User ID 1 Backup SIP User ID 2	Type the SIP User ID of the Backup SIP Server (up to 25 alphanumeric characters).
Backup Authenticate ID 1 Backup Authenticate ID 2	Type the Authenticate ID of the Backup SIP Server (up to 25 alphanumeric characters).
Backup Authenticate Password 1 Backup Authenticate Password 2	Type the Authenticate Password of the Backup SIP Server (up to 25 alphanumeric characters).
Remote SIP Port	Type the Remote SIP Port number (default 5060) (0 - 65535).
Local SIP Port*	Type the Local SIP Port number (default 5060) (0 - 65535).
Outbound Proxy	Type the Outbound Proxy as either a numeric IP address in dotted decimal notation or the fully qualified host name (64 character limit [FQDN]).
Outbound Proxy Port	Type the Outbound Proxy Port number (0 - 65535).
Register with a SIP Server	Enable or disable SIP Registration.
Re-registration Interval (in seconds)*	Type the SIP Registration lease time in seconds (default is 120 seconds) (range is 100 - ?).
Unregister on Reboot*	<ul style="list-style-type: none"> • When selected, the Loudspeaker Amplifier automatically unregisters when it is rebooted. • When not selected, the Loudspeaker Amplifier remains registered when it is rebooted.

Table 2-14. SIP Configuration Parameters (continued)

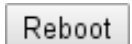
Web Page Item	Description
Buffer SIP Calls	When this is enabled, SIP calls to the speaker will be stored in memory and will play when either the call is terminated or the buffer is full. The receive buffer is 2MB in size and this is equal to about four minutes of ulaw encoded audio.
Beep Before Page	Enable/Disable the tone (beep) before each page.
RTP Settings	
RTP Port (even)	Specify the port number used for the RTP stream after establishing a SIP call. The RTP port has to be an even number between 0 and 65534. This port can be programmed for people who are not working on a local LAN, but who want to have outside access. Instead of RTP port being a random port, it will be set up so that only two ports can be opened in a firewall. Note: The RTP port number has to be an even number because the control port is always one port number higher. Therefore, audio will go through the port number that you enter into the RTP port field, but the RTP control signals will go through a port that is one number higher than the RTP port field.
	Click the Save button to save your configuration settings. Note: You need to reboot for changes to take effect.
	Click on the Reboot button to reboot the system.

3. After changing the parameters, click **Save** to save the settings.

2.3.6 Configure the Nightringer Parameters

 <p>GENERAL ALERT</p>	<p>Caution Nightringer requires SIP Registration. Nightringer cannot be used in peer to peer mode.</p>
--	---

1. Click on the **Nightringer** button to open the **Nightringer Configuration** page. See [Figure 2-27](#).

Figure 2-25. Night Ringer Configuration Setup

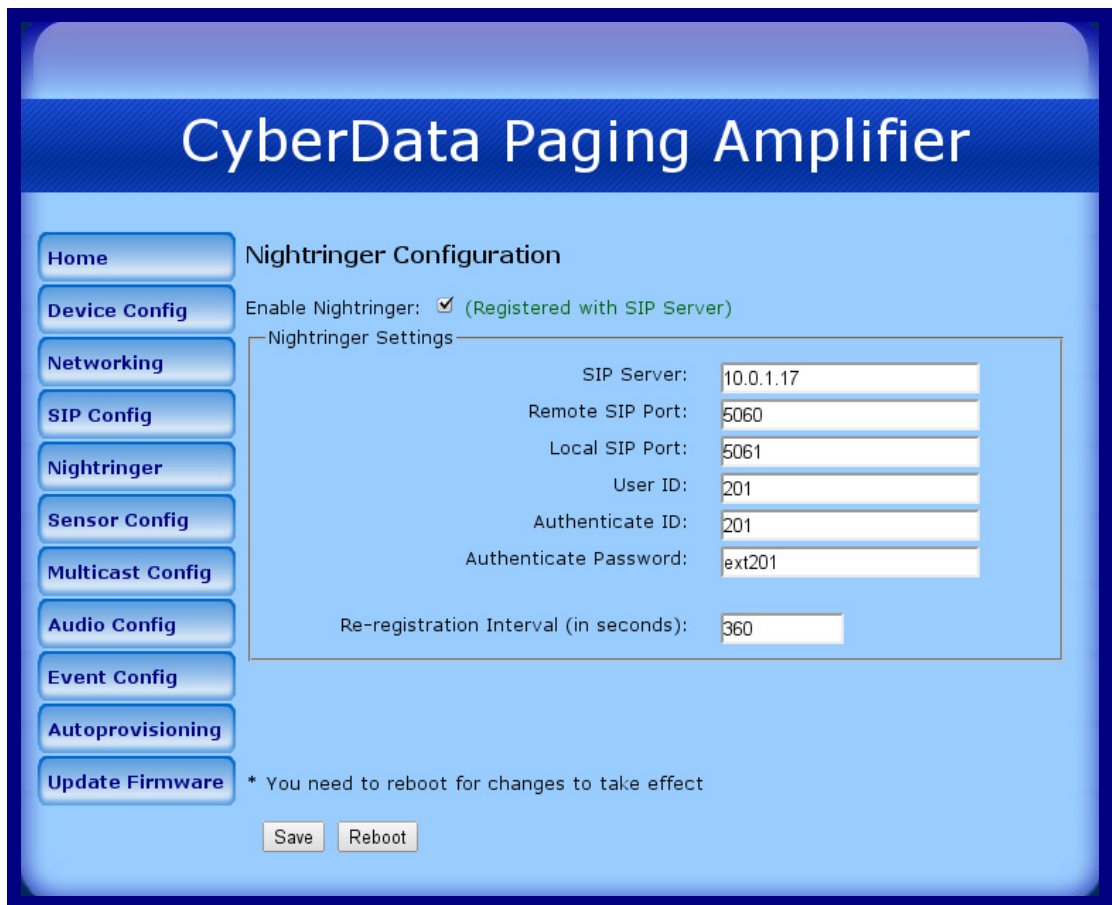

CyberData Paging Amplifier

Home **Nightringer Configuration**

Device Config Enable Nightringer: (Registered with SIP Server)

Networking Nightringer Settings

SIP Config SIP Server: 10.0.1.17

Nightringer Remote SIP Port: 5060

Sensor Config Local SIP Port: 5061

Multicast Config User ID: 201

Audio Config Authenticate ID: 201

Event Config Authenticate Password: ext201

Autoprovisioning Re-registration Interval (in seconds): 360

Update Firmware * You need to reboot for changes to take effect

Save Reboot

- On the **Nightringer Configuration** page, enter values for the parameters indicated in [Table 2-17](#).

Table 2-15. Nightringer Configuration Parameters

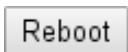
Web Page Item	Description
Enable Nightringer	When the nightringer is enabled, the device will attempt to register a second extension with the SIP server. Any calls made to this extension will play a ringtone.
Nightringer Settings	
SIP Server	Type the SIP server represented as either a numeric IP address in dotted decimal notation.
Remote SIP Port	Type the Remote SIP Port number (default 5060) (8 character limit).
Local SIP Port	Type the Local SIP Port number (default 5060) (8 character limit). Note: This value cannot be the same as the Local SIP Port* found on the SIP Configuration Page .
User ID	Type the User ID (up to 64 alphanumeric characters).
Authenticate ID	Type the Authenticate ID (up to 64 alphanumeric characters).
Authenticate Password	Type the Authenticate Password (up to 64 alphanumeric characters).
Re-registration Interval (in seconds)*	Type the SIP Registration lease time in minutes (default is 60 minutes) (8 character limit). Re-registration Interval (in seconds)*
	Click the Save button to save your configuration settings. Note: You need to reboot for changes to take effect.
	Click on the Reboot button to reboot the system.

- After changing the parameters, click on the **Save** button.

2.3.7 Configure the Sensor Configuration Parameters

The sensor (pins 1 and 2) on the header can be used to monitor something's open or closed state. There is an option on the **Sensor Configuration** page to trigger on an open or short condition on these pins.

For the sensor there are three actions that the Loudspeaker Amplifier can do:

- Activate the relay until the sensor is deactivated
- Loop an audio file until the sensor is deactivated
- Call a preset extension and play a pre-recorded audio file (loops until user hangs up)

Note Calling a preset extension can be set up as a point-to-point call, but currently can't send delayed DTMF tones.

1. Click **Sensor Config** to open the **Sensor Configuration** page (Figure 2-26).

Figure 2-26. Sensor Configuration Page

CyberData Paging Amplifier

Home Device Config Networking SIP Config Nightringer **Sensor Config** Multicast Config Audio Config Event Config Autoprovisioning Update Firmware

Sensor Configuration

Sensor Settings

Sensor Normally Closed: Yes No

Activate Relay:

Play Audio Locally:

Play Audio Remotely:

Dial Out Extension: 204



Test Sensor

* You need to reboot for changes to take effect

Save Reboot

2. On the **Sensor Configuration** page, enter values for the parameters indicated in [Table 2-16](#).

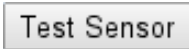
Table 2-16. Sensor Configuration Parameters

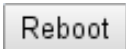
Web Page Item	Description
Sensor Settings	
Sensor Normally Closed	Select the inactive state of the sensors.
Activate Relay	Check this box to activate the relay until the sensor is deactivated.
Play Audio Locally	Check this box to loop an audio file until the sensor is deactivated.
Play Audio Remotely	Check this box to make only one call to a preset extension and play a pre-recorded audio file repeatedly.
Dial Out Extension	Enter the dial-out extension number.
	Use this button to test the sensor.
	Click the Save button to save your configuration settings. Note: You need to reboot for changes to take effect.
	Click on the Reboot button to reboot the system.

3. After changing the parameters, click **Save Settings**.

2.3.8 Configure the Multicast Configuration Parameters

Multicast groups use multicasting to create public address paging zones. Multicasting is based on the concept of a group. Multicast addresses specify an arbitrary group of IP hosts that have joined the group and want to receive traffic sent to the group. Group members send IGMP messages to their local multicast routers, allowing the group traffic traversal from the source.

Multicast configuration provides the ability to join up to 10 paging zones. A paging zone can consist of one, or many, CyberData multicast group-enabled Loudspeaker Amplifiers. There is no limit to how many Loudspeaker Amplifiers can be in a given paging zone. Each multicast group is defined by a multicast address and port number. Each multicast group is also assigned a priority, allowing simultaneously arriving pages to be serviced based on importance. Multicast groups are compatible with IGMP through version 3.

Note The Loudspeaker Amplifier supports simultaneous SIP and Multicast.

1. Click on the **Multicast Configuration** button to open the **Multicast Configuration** page. See [Figure 2-27](#).

Figure 2-27. Multicast Configuration Setup

CyberData Paging Amplifier

Multicast Configuration

Enable Multicast operation:

Priority	Address	Port	Name	Buffer	Beep	Relay
9	239.168.3.10	11000	Emergency	<input checked="" type="checkbox"/>	<input type="checkbox"/>	<input type="checkbox"/>
8	239.168.3.9	10000	MG8	<input type="checkbox"/>	<input type="checkbox"/>	<input type="checkbox"/>
7	239.168.3.8	9000	MG7	<input type="checkbox"/>	<input type="checkbox"/>	<input type="checkbox"/>
6	239.168.3.7	8000	MG6	<input type="checkbox"/>	<input type="checkbox"/>	<input type="checkbox"/>
5	239.168.3.6	7000	MG5	<input type="checkbox"/>	<input type="checkbox"/>	<input type="checkbox"/>
SIP calls are considered priority 4.5						
4	239.168.3.5	6000	MG4	<input type="checkbox"/>	<input type="checkbox"/>	<input type="checkbox"/>
3	239.168.3.4	5000	MG3	<input type="checkbox"/>	<input type="checkbox"/>	<input type="checkbox"/>
2	239.168.3.3	4000	MG2	<input type="checkbox"/>	<input type="checkbox"/>	<input type="checkbox"/>
1	239.168.3.2	3000	MG1	<input type="checkbox"/>	<input type="checkbox"/>	<input type="checkbox"/>
0	239.168.3.1	2000	Background Music	<input type="checkbox"/>	<input type="checkbox"/>	<input type="checkbox"/>

Port range can be from 2000-65535
Priority 9 is the highest and 0 is the lowest
A higher priority audio stream will always supercede a lower one
Priority 9 streams will play at maximum volume

* You need to reboot for changes to take effect

2. On the **Multicast Configuration** page, enter values for the parameters indicated in [Table 2-17](#).

Table 2-17. Multicast Configuration Parameters

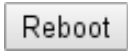
Web Page Item	Description
Enable Multicast Operation	Enables or disables multicast operation.
Priority	Indicates the priority for the multicast group. Priority 9 is the highest (emergency streams). 0 is the lowest (background music). See Section 2.3.8.1, "Assigning Priority" for more details.
Address	Enter the multicast IP Address for this multicast group (15 character limit).
Port (range can be from 2000 to 65535)	Enter the port number for this multicast group (5 character limit). Note: The multicast ports have to be even values. The webpage will enforce this restriction.
Name	Assign a descriptive name for this multicast group (25 character limit).
Buffer	When buffering is enabled for a multicast stream, it will store any audio received on this socket to memory and play it back when the stream is stopped or the buffer is full.
Beep	Enable or disable the tone (beep) for a multicast stream.
Relay	Enable or disable the relay for a multicast stream.
	Click the Save button to save your configuration settings. Note: You need to reboot for changes to take effect.
	Click on the Reboot button to reboot the system.

3. After changing the parameters, click on the **Save** button.

2.3.8.1 Assigning Priority

When playing multicast streams, audio on different streams will preempt each other according to their priority in the list. An audio stream with a higher priority will interrupt a stream with a lower priority.

If both SIP and Multicast is enabled, SIP audio streams are considered priority **4.5**. SIP audio will interrupt multicast streams with priority **0** through **4** and will be interrupted by multicast streams with priority **5** through **9**.

During priority **9** multicast streams, the analog volume control is bypassed and the volume level is set to maximum.

Line In audio is considered the lowest priority, so it will be muted if there are any multicast or SIP audio streams playing.

For example, if the test audio button on the Device Config page is pressed while music is playing via the Enabled Line In feature, the music will be muted during the test audio message.

Note SIP calls, buffered SIP calls, multicast streams, buffered multicast streams, ring tones, ringback tones, and nightring tones are all prioritized.

Ringtones and Nightringtones

Ringtones all play at the same priority level. This means that it is possible to have a nightring tone and a normal ringtone playing at the same time.

The maximum ringtone duration is 2,097,152 bytes or about four minutes of ulaw audio.

Lengthy Pages

Concerning how lengthy pages are handled (where someone puts the phone down for 15 minutes), after the 2MB limit is reached, further data will be thrown away while the audio file is played back. When the file is done playing, it will stop throwing away input and begin buffering data for another four minutes.

Therefore, with the buffered mode enabled on a stream playing background music, you will hear the following sequence of events:

1. Four minutes of silence.
2. Music from 0:00 through 4:00.
3. Four minutes of silence.
4. Music from 8:00 through 12:00 and so on.

Buffered Audio

When the device is playing back buffered audio and this buffered audio is interrupted by a higher priority stream, once the higher priority streams is finished, the device will restart the lower priority stream from the beginning.

2.3.9 Configure the Audio Parameters

Click the **Audio Config** button to open the **Audio Configuration** page. The **Audio Configuration** page is used to add custom audio to the board. User uploaded audio will take precedence over the audio files shipped with the Loudspeaker Amplifier.

Figure 2-28. Audio Configuration Page



Figure 2-29. Audio Configuration Page (continued)

9: Currently set to default
New File: No file chosen

Dot: Currently set to default
New File: No file chosen

Audio test: Currently set to default
New File: No file chosen

Page tone: Currently set to default
New File: No file chosen

Your IP Address is: Currently set to default
New File: No file chosen

Rebooting: Currently set to default
New File: No file chosen

Restoring Default: Currently set to default
New File: No file chosen

Ringback tone: Currently set to default
New File: No file chosen

Ring tone: Currently set to default
New File: No file chosen

Sensor Triggered: Currently set to default
New File: No file chosen

Night Ring: Currently set to default
New File: No file chosen

On the **Audio Configuration** page, enter values for the parameters indicated in [Table 2-18](#).

Note Each entry on the **Audio Configuration** page replaces one of the stock audio files on the board. When the input box displays the word **default**, the Loudspeaker Amplifier is using the stock audio file. If that file is replaced with a user file, it will display the uploaded filename.

Table 2-18. Audio Configuration Parameters





Web Page Item	Description
Audio Files	
0-9	The name of the audio configuration option is the same as the spoken audio that plays on the board (24 character limit). '0' corresponds to the spoken word "zero." '1' corresponds to the spoken word "one." '2' corresponds to the spoken word "two." '3' corresponds to the spoken word "three." '4' corresponds to the spoken word "four." '5' corresponds to the spoken word "five." '6' corresponds to the spoken word "six." '7' corresponds to the spoken word "seven." '8' corresponds to the spoken word "eight." '9' corresponds to the spoken word "nine."
Dot	Corresponds to the spoken word "dot." (24 character limit)
Audiotest	Corresponds to the message "This is the CyberData IP speaker test message..." (24 character limit)
Pagetone	Corresponds to a simple tone that is unused by default (24 character limit).
Your IP Address is	Corresponds to the message "Your IP address is..." (24 character limit).
Rebooting	Corresponds to the spoken word "Rebooting" (24 character limit).
Restoring default	Corresponds to the message "Restoring default" (24 character limit).
Ringback Tone	Corresponds to the ringback tone that plays when calling a remote extension (24 character limit).
Ring Tone	Corresponds to the tone that plays when set to ring when receiving a call (24 character limit).
Sensor Triggered	Corresponds to the sensor when it is triggered (24 character limit).
Night Ring	Specifies the ringtone for Night Ringer. By default this parameter uses the same audio file that is selected for the Ring Tone parameter.
	The Choose File button will allow you to navigate to and select an audio file.
	The Play button will play that audio file.
	The Delete button will delete any user uploaded audio and restore the stock audio file.

Table 2-18. Audio Configuration Parameters (continued)

Web Page Item	Description
	The Save button will download a new user audio file to the board once you've selected the file by using the Browse button. The Save button will delete any pre-existing user-uploaded audio files.

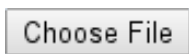
2.3.10 User-created Audio Files

User created audio files should be saved in the following format:

RIFF (little-endian) data, WAVE audio, Microsoft PCM, 16 bit, mono 8000 Hz

You can use the free utility *Audacity* to convert audio files into this format. See [Figure 2-30](#) through [Figure 2-32](#).

Figure 2-30. Audacity 1

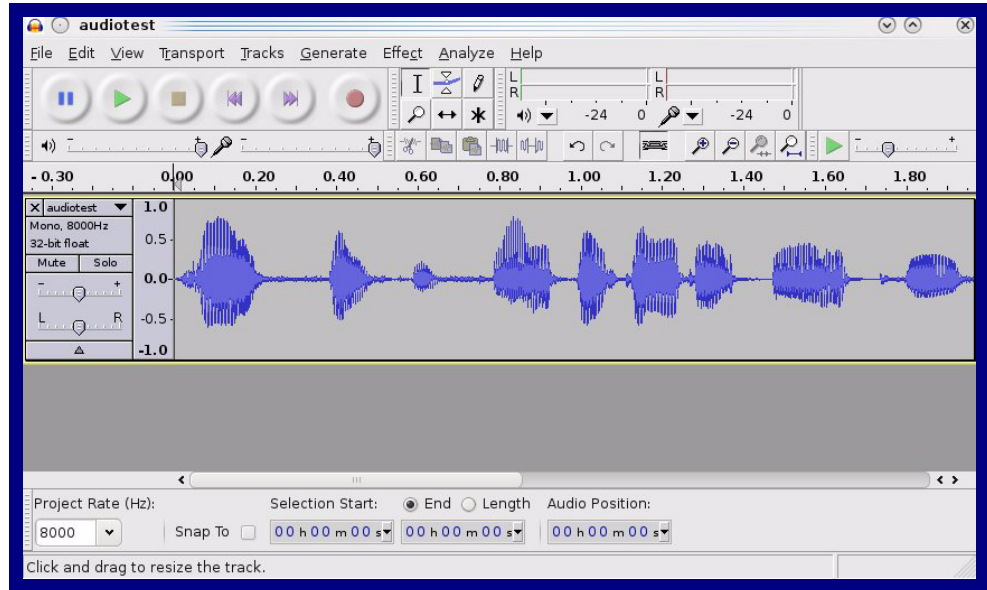
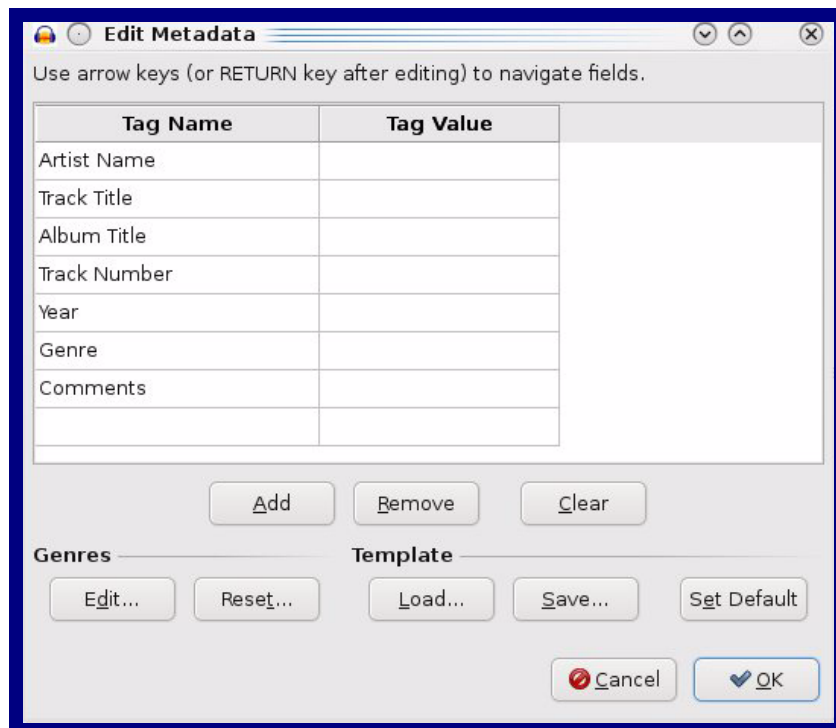

Figure 2-31. Audacity 2



When you export an audio file with Audacity, save the output as:

- **WAV (Microsoft) signed 16 bit PCM.**

Figure 2-32. WAV (Microsoft) signed 16 bit PCM

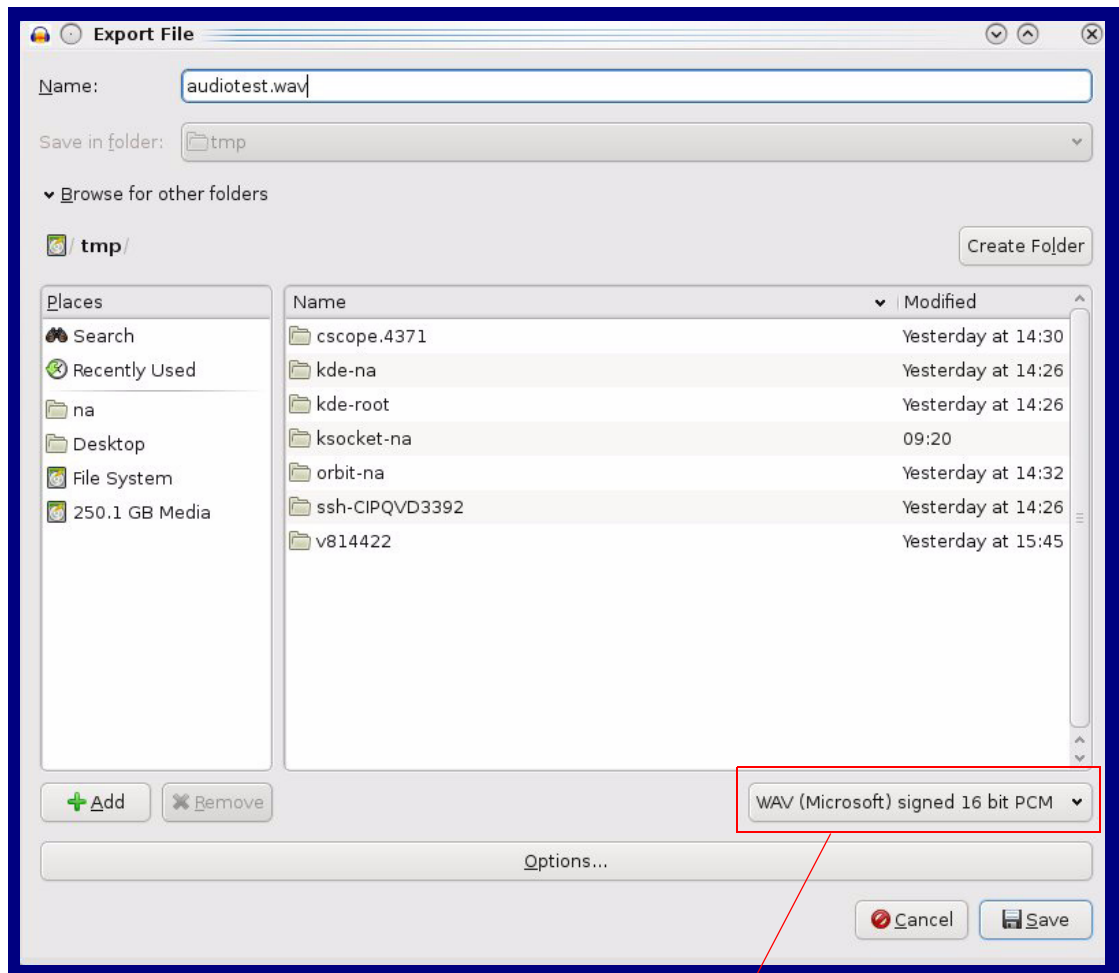

WAV (Microsoft) signed 16 bit PCM

2.3.11 Configure the Event Parameters

Click the **Event Config** button to open the **Event Configuration** page (Figure 2-33). The **Event Configuration** page specifies a remote server that can be used to receive HTTP POST events when actions take place on the board.

Figure 2-33. Event Configuration Page

CyberData Paging Amplifier

Home
Device Config
Networking
SIP Config
Nightringer
Sensor Config
Multicast Config
Audio Config
Event Config
Autoprovisioning
Update Firmware

Event Configuration

Enable Event Generation:

Remote Event Server

Remote Event Server IP:

Remote Event Server Port:

Remote Event Server URL:

Events

Enable Call Active Events:

Enable Call Terminated Events:

Enable Relay Activated Events:

Enable Relay Deactivated Events:

Enable Ring Events:

Enable Night Ring Events:

Enable Multicast Start Events:

Enable Multicast Stop Events:

Enable Power on Events:

Enable Sensor Events:



Enable 60 second Heartbeat Events:

* You need to reboot for changes to take effect

Save Test Event Reboot

Table 2-19 shows the web page items on the **Event Configuration** page.

Table 2-19. Event Configuration

Web Page Item	Description
Enable Event Generation	When selected, Event Generation is enabled.
Remote Event Server	
Remote Event Server IP	Type the Remote Event Server IP address. (64 character limit)
Remote Event Server Port	Type the Remote Event Server port number. (0 - 65535)
Remote Event Server URL	Type the Remote Event Server URL. (127 character limit)
Events	
Enable Call Active Events	When selected, Call Active Events are enabled.
Enable Call Terminated Events	When selected, Call Terminated Events are enabled.
Enable Relay Activated Events	When selected, Relay Activated Events are enabled.
Enable Relay Deactivated Events	When selected, Relay Deactivated Events are enabled.
Enable Ring Events	When selected, Ring Events are enabled.
Enable Night Ring Events	When selected, there is a notification when the device receives a night ring.
Enable Multicast Start Events	When selected, Multicast Start Events are enabled.
Enable Multicast Stop Events	When selected, Multicast Stop Events are enabled.
Enable Power On Events	When selected, Power On Events are enabled.
Enable Sensor Events	When selected, Sensor Events are enabled.
Enable 60 Second Heartbeat Events	When selected, 60 Second Heartbeat Events are enabled.
	Click the Save button to save your configuration settings. Note: You need to reboot for changes to take effect.
	Click on the Test Event button to test an event.
	Click on the Reboot button to reboot the system.

2.3.11.1 Example Packets for Events

The server and port are used to point to the listening server and the 'Remote Event Server URL' is the destination URL (typically the script running on the remote server that's used to parse and process the POST events).

Note The XML is URL-encoded before transmission so the following examples are not completely accurate.

Here are example packets for every event:

```
POST xmlparse_engine HTTP/1.1
Host: 10.0.3.79
User-Agent: CyberData/1.0.0
Content-Length: 197
Content-Type: application/x-www-form-urlencoded
```

```
<?xml version="1.0" encoding="ISO-8859-1"?>
<cyberdata NAME='CyberData VoIP Device' MAC='0020f70015b6'>
<event>POWERON</event>
</cyberdata>
```

```
POST xmlparse_engine HTTP/1.1
Host: 10.0.3.79
User-Agent: CyberData/1.0.0
Content-Length: 199
Content-Type: application/x-www-form-urlencoded
```

```
<?xml version="1.0" encoding="ISO-8859-1"?>
<cyberdata NAME='CyberData VoIP Device' MAC='0020f70015b6'>
<event>HEARTBEAT</event>
</cyberdata>
```

```
POST xmlparse_engine HTTP/1.1
Host: 10.0.3.79
User-Agent: CyberData/1.0.0
Content-Length: 196
Content-Type: application/x-www-form-urlencoded
```

```
<?xml version="1.0" encoding="ISO-8859-1"?>
<cyberdata NAME='CyberData VoIP Device' MAC='0020f70015b6'>
<event>BUTTON</event>
</cyberdata>
```

```
POST xmlparse_engine HTTP/1.1
Host: 10.0.3.79
User-Agent: CyberData/1.0.0
Content-Length: 201
Content-Type: application/x-www-form-urlencoded
```

```
<?xml version="1.0" encoding="ISO-8859-1"?>
<cyberdata NAME='CyberData VoIP Device' MAC='0020f70015b6'>
<event>CALL_ACTIVE</event>
</cyberdata>
POST xmlparse_engine HTTP/1.1
```

```
Host: 10.0.3.79
User-Agent: CyberData/1.0.0
Content-Length: 205
Content-Type: application/x-www-form-urlencoded

<?xml version="1.0" encoding="ISO-8859-1"?>
<cyberdata NAME='CyberData VoIP Device' MAC='0020f70015b6'>
<event>CALL_TERMINATED</event>
</cyberdata>

POST xmlparse_engine HTTP/1.1
Host: 10.0.3.79
User-Agent: CyberData/1.0.0
Content-Length: 197
Content-Type: application/x-www-form-urlencoded

<?xml version="1.0" encoding="ISO-8859-1"?>
<cyberdata NAME='CyberData VoIP Device' MAC='0020f70015b6'>
<event>RINGING</event>
</cyberdata>

POST xmlparse_engine HTTP/1.1
Host: 10.0.3.79
User-Agent: CyberData/1.0.0
Content-Length: 234
Content-Type: application/x-www-form-urlencoded

<?xml version="1.0" encoding="ISO-8859-1"?>
<cyberdata NAME='CyberData VoIP Device' MAC='0020f70015b6'>
<event>MULTICAST_START</event>
<index>8</index>
</cyberdata>

POST xmlparse_engine HTTP/1.1
Host: 10.0.3.79
User-Agent: CyberData/1.0.0
Content-Length: 233
Content-Type: application/x-www-form-urlencoded

<?xml version="1.0" encoding="ISO-8859-1"?>
<cyberdata NAME='CyberData VoIP Device' MAC='0020f70015b6'>
<event>MULTICAST_STOP</event>
<index>8</index>
</cyberdata>

POST xmlparse_engine HTTP/1.1
Host: 10.0.3.79
User-Agent: CyberData/1.0.0
Content-Length: 234
Content-Type: application/x-www-form-urlencoded
<?xml version="1.0" encoding="ISO-8859-1"?>
<cyberdata NAME='CyberData VoIP Device' MAC='0020f70015b6'>
<event>RELAY_ACTIVATED</event>
</cyberdata>
POST xmlparse_engine HTTP/1.1
```

```
Host: 10.0.3.79
User-Agent: CyberData/1.0.0
Content-Length: 234
Content-Type: application/x-www-form-urlencoded
<?xml version="1.0" encoding="ISO-8859-1"?>
<cyberdata NAME='CyberData VoIP Device' MAC='0020f70015b6'>
<event>RELAY_DEACTIVATED</event>
</cyberdata>
```

```
POST xmlparse_engine HTTP/1.1
Host: 10.0.3.79
User-Agent: CyberData/1.0.0
Content-Length: 234
Content-Type: application/x-www-form-urlencoded
<?xml version="1.0" encoding="ISO-8859-1"?>
<cyberdata NAME='CyberData VoIP Device' MAC='0020f70015b6'>
<event>NIGHTRINGING</event>
</cyberdata>
```

2.3.12 Configure the Autoprovisioning Parameters

1. Click the **Autoprovisioning** button to open the **Autoprovisioning Configuration** page.
See [Figure 2-22](#).

Figure 2-34. Autoprovisioning Configuration Page

The screenshot shows the 'Autoprovisioning' configuration page for a CyberData Paging Amplifier. The page has a blue header with the title 'CyberData Paging Amplifier'. On the left side, there is a vertical menu with buttons for 'Home', 'Device Config', 'Networking', 'SIP Config', 'Nightringer', 'Sensor Config', 'Multicast Config', 'Audio Config', 'Event Config', 'Autoprovisioning' (which is highlighted), and 'Update Firmware'. The main content area is titled 'Autoprovisioning' and contains the following settings:

- Enable Autoprovisioning:
- Get Autoprovisioning from DHCP:
- Autoprovisioning Server (IP Address):
- Autoprovisioning autoupdate (in minutes):



Below the settings, there are two asterisked notes:

- * Autoprovisioning file name: 0020f701904e.config
- * You need to reboot for changes to take effect

At the bottom of the configuration area, there are two buttons: 'Save' and 'Reboot'.

2. On the **Autoprovisioning Configuration** page, you may enter values for the parameters indicated in [Table 2-12](#).

Table 2-20. Autoprovisioning Configuration Parameters

Web Page Item	Description
Autoprovisioning	
Enable Autoprovisioning	See Section 2.3.12.1, "Autoprovisioning" .
Get Autoprovisioning from DHCP	See Section 2.3.12.1, "Autoprovisioning" .
Autoprovisioning Server (IP Address)	See Section 2.3.12.1, "Autoprovisioning" (15 character limit).
Autoprovisioning Autoupdate (in minutes)	Type the desired time (in minutes) that you want the Autoprovisioning feature to update (6 character limit).
	Click the Save button to save your configuration settings. Note: You need to reboot for changes to take effect.
	Click on the Reboot button to reboot the system.

3. After changing the parameters, click the **Save** button.

2.3.12.1 Autoprovisioning

Enable Autoprovisioning Option With autoprovisioning enabled, the board will get its configuration from a remote TFTP server on startup or periodically on a scheduled delay. Autoprovisioned values will override values stored in on-board memory and will be visible on the web page. The board gets its autoprovisioning information from an XML-formatted file hosted from a TFTP server. CyberData will provide a template for this XML file and the user can modify it for their own use.

To use autoprovisioning, create a copy of the autoprovisioning template with the desired settings and name this file with the mac address of the device to configure (for example: **0020f7350058.config**). Put this file into your TFTP server directory and manually set the TFTP server address on the board.

It is not necessary to set every option found in the autoprovisioning template. As long as the XML is valid, the file can contain any subset. Options not autoprovisioned will default to the values stored in the on board memory. For example if you only wanted to modify the device name, the following would be a valid autoprovisioning file:

```
<?xml version="1.0" encoding="utf-8" ?>
<specific>
  <MiscSettings>
    <DeviceName>auto V2 Paging Amplifier</DeviceName>
  </MiscSettings>
</specific>
```

Networking The board will only apply networking settings or firmware upgrades after a reboot.

Get Autoprovisioning from DHCP When this option is checked, the device will automatically fetch its autoprovisioning server address from the DHCP server. The device will use the address specified in **OPTION 150** (TFTP-server-name) or **OPTION 66**. If both options are set, the device will use **OPTION 150**.

Refer to the documentation of your DHCP server for setting up **OPTION 150**.

To set up a Linux DHCPD server to serve autoprovisioning information (in this case using both option 66 and 150), here's an example dhcpd.conf:

```
# dhcpd.conf
#
# Configuration file for ISC dhcpd (see 'man dhcpd.conf')
#
ddns-update-style ad-hoc;

option option-150 code 150 = ip-address;

subnet 10.0.0.0 netmask 255.0.0.0 {
    max-lease-time 120;
    default-lease-time 120;

    option routers                10.0.0.1;
    option subnet-mask            255.0.0.0;

    option domain-name            "voiplab";
    option domain-name-servers    10.0.0.1;

    option time-offset            -8;      # Pacific Standard Time

    option tftp-server-name       "10.0.0.254";

    option option-150             10.0.0.254;

    range 10.10.0.1 10.10.2.1;}

```

Autoprovisioning Server (IP Address) Instead of using DHCP to provide the autoprovisioning tftp server address, you can specify an address manually.

Autoprovisioning Autoupdate If **Autoprovisioning** is enabled and the **Autoprovisioning Autoupdate** value is something other than **0** minutes, a service is started on startup that will wait the configured number of minutes and then try to re-download its autoprovisioning file. It will compare its previously autoprovisioned file with this new file and if there are differences, it will reboot the board.

Autoprovisioned Firmware Upgrades An Autoprovisioned firmware upgrade only happens after a reboot, will take roughly three minutes, and the web page will be unresponsive during this time.

The '**FirmwareVersion**' value in the xml file *must* match the version stored in the '**FirmwareFile**'.

```
<FirmwareVersion>v5.0.5b01</FirmwareVersion>
<FirmwareFile>505b01-uImage-ceilingSpeak</FirmwareFile>
```

If these values are mismatched, the board can get stuck in a loop where it goes through the following sequence of actions:

1. The board downloads and writes a new firmware file.
2. After the next reboot, the board recognizes that the firmware version does not match.
3. The board downloads and writes the firmware file again.

CyberData has timed a firmware upgrade at 140 seconds. Therefore, if you suspect the board is stuck in a loop, either remove or comment out the **FirmwareVersion** line in the XML file and let the board boot as it normally does.

Autoprovisioned
Audio Files

Audio files are stored in non-volatile memory and an autoprovisioned audio file will only have to be downloaded once for each device. Loading many audio files to the device from the web page could cause it to appear unresponsive. If this happens, wait until the transfer is complete and then refresh the page.

The device uses the file name to determine when to download a new audio file. This means that if you used autoprovisioning to upload a file and then changed the contents of this file at the TFTP server, the device will not recognize that the file has changed (because the file name is the same).

Since audio files are stored in non-volatile memory, if autoprovisioning is disabled after they have been loaded to the board, the audio file settings will not change. You can force a change to the audio files on the board by clicking the **Delete** button on the **Audio Configuration** page or by changing the autoprovisioning file with “**default**” set as the file name.

2.3.13 Upgrading the Firmware

To upload the Loudspeaker Amplifier firmware from your PC:

1. Retrieve the latest Loudspeaker Amplifier firmware from the VoIP V2 Loudspeaker Amplifier **Downloads** page at:
<http://www.cyberdata.net/products/voip/digitalanalog/loudspeakerampv2/downloads.html>
2. Unzip the Loudspeaker Amplifier version file. This file may contain the following:
 - Firmware file
 - Release notes
3. Log in to the Loudspeaker Amplifier home page as instructed in [Section 2.3.2, "Log in to the Configuration Home Page"](#).

4. Click the **Update Firmware** button to open the **Upgrade Firmware** page. See [Figure 2-35](#).

Figure 2-35. Firmware Upgrade Page

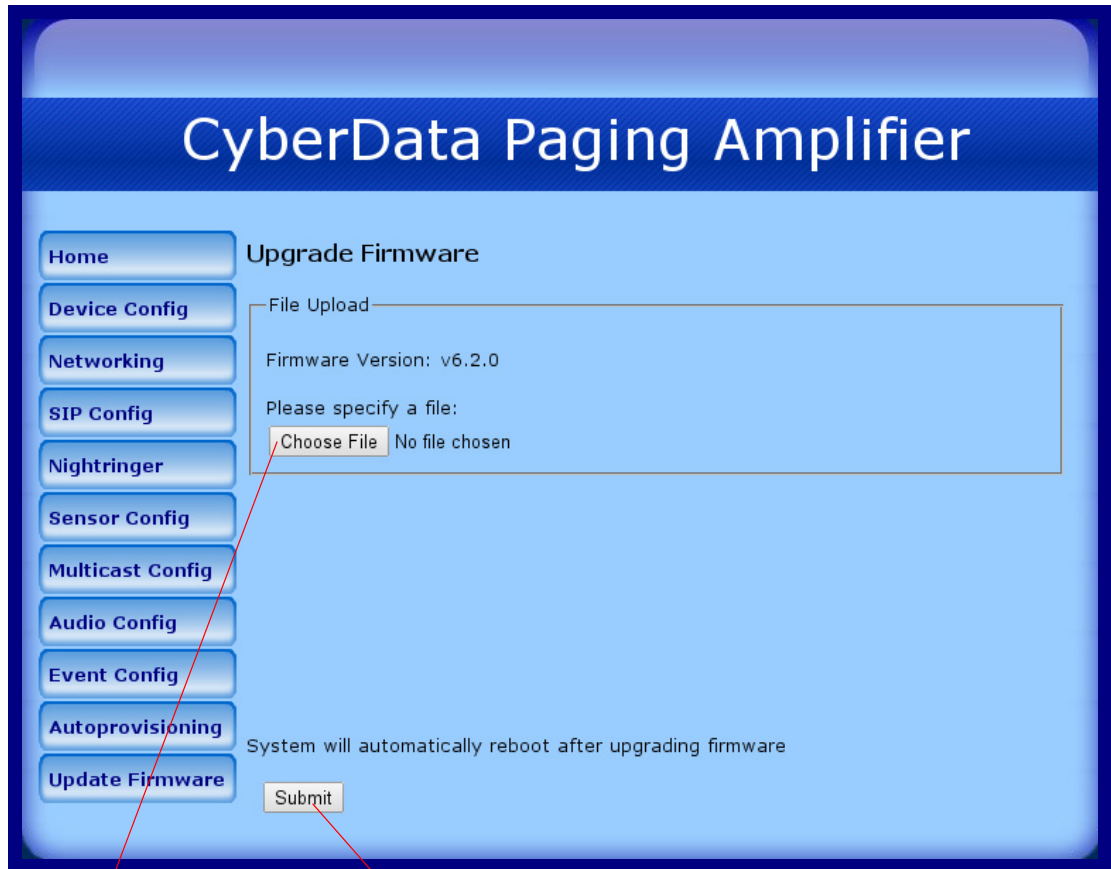



Choose File button

Submit button

5. Click the **Choose File** button, and then navigate to the location of the Loudspeaker Amplifier firmware file.
6. Click the **Submit** button. This starts the upload process. Once the Loudspeaker Amplifier has uploaded the file, the **Uploading Firmware** countdown page appears, indicating that the firmware is being written to flash.
7. The Loudspeaker Amplifier will automatically reboot when the upload is complete.
8. When the countdown finishes, the **Upgrade Firmware** page will refresh. The uploaded firmware filename should be displayed in the system configuration (indicating a successful upgrade and reboot).

Table 2-21 shows the web page items on the **Upgrade Firmware** page.

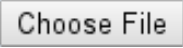
Table 2-21. Firmware Upgrade Parameters

Web Page Item	Description
File Upload	
Firmware Version	Shows the current firmware version.
	Use the Choose File button to navigate to the location of the Intercom firmware file that you want to upload.
	Click on the Submit button to automatically upload the selected firmware and reboot the system.

2.3.14 Reboot the Loudspeaker Amplifier

To reboot a Loudspeaker Amplifier, log in to the web page as instructed in [Section 2.3.2, "Log in to the Configuration Home Page"](#).

1. On the Home Page, click the **Reboot** button. See [Figure 2-36](#).

Figure 2-36. Home Page

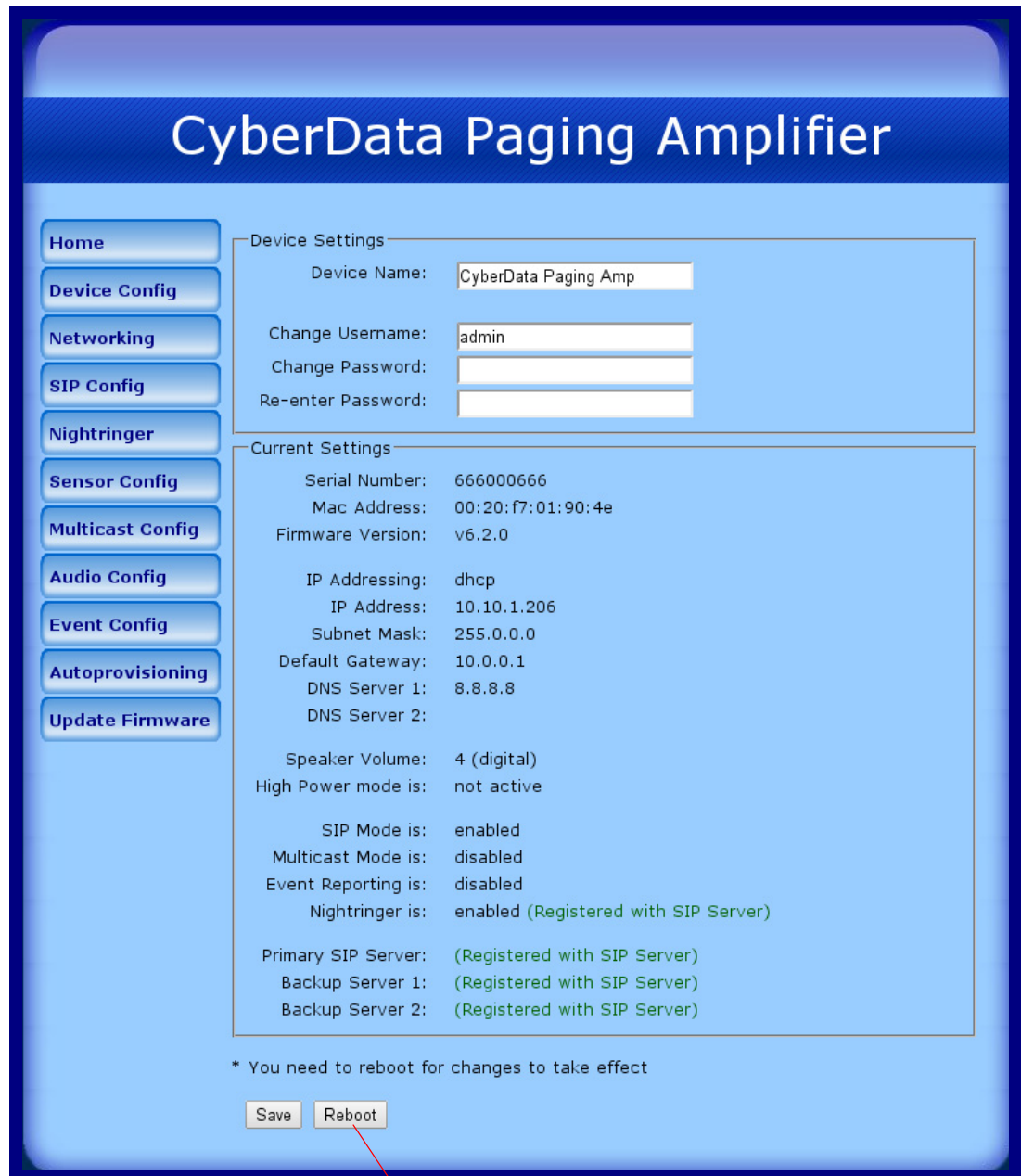

Reboot button





2. A normal restart will occur and you will see the following **Reboot** page (Figure 2-37).

Figure 2-37. Reboot Page



Appendix A: Mounting the Amplifier

A.1 Important Safety Instructions

 <p>GENERAL ALERT</p>	<p>Warning <i>Electrical Hazard:</i> The VoIP V2 Loudspeaker Amplifier enclosure is not rated for any AC voltages.</p>
 <p>GENERAL ALERT</p>	<p>Warning <i>Electrical Hazard:</i> This product should be installed by a licensed electrician according to all local electrical and building codes.</p>
 <p>GENERAL ALERT</p>	<p>Warning <i>Electrical Hazard:</i> To prevent injury, this apparatus must be securely attached to the floor/wall in accordance with the installation instructions.</p>
 <p>GENERAL ALERT</p>	<p>Warning The PoE connector is intended for intra-building connections only and does not route to the outside plant.</p>

A.2 Mount the Amplifier

Before you mount the enclosure, make sure that you have received all of the parts for each enclosure. Refer to [Table A-22](#).

Table A-22. Wall Mounting Components (Part of the Accessory Kit)

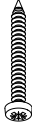
Quantity	Part Name	Illustration
3	#6 Plastic Ribbed Anchors	
3	#6 Sheet Metal Screws	

Note The Loudspeaker Amplifier was designed for indoor use. Mounting it on the external part of a building will require additional hardware for weatherproofing, cabling access, and lightning suppression. Consult a certified electrician for details.

Note For mounting, use the three **#6 SHEET METAL SCREWS** to secure the enclosure.

A.2.1 Mounting the Enclosure

To mount the enclosure:

1. Prepare holes for the screws.
2. Plug in the power adapter and use the green Power light to verify that the power is on.
3. Plug the Ethernet cable into the Loudspeaker Amplifier. The yellow Link light verifies the network connection.
4. For wall mounting, use the three #6 x 1-1/4-inch Pan Head Phillip screws to secure the speaker. See [Figure A-1](#).

Figure A-1. Mounting the Enclosure

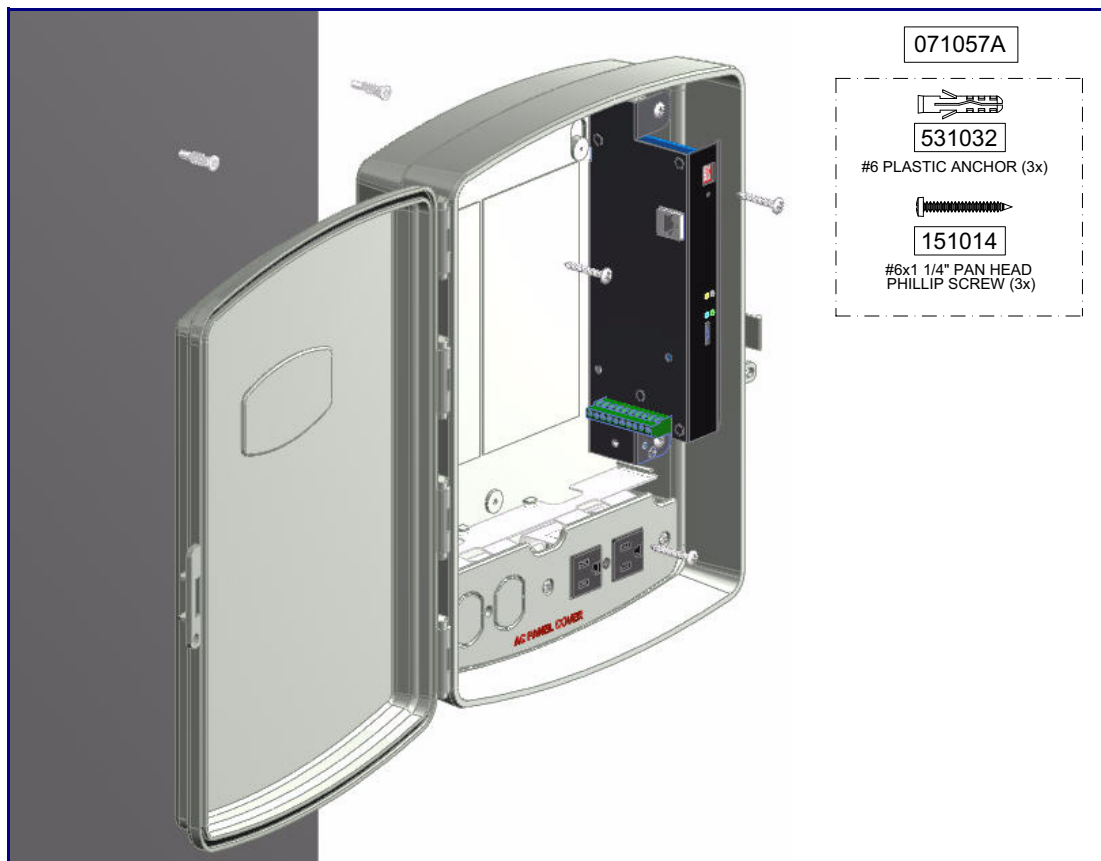

Wiring the 125V AC Plug



Caution

Equipment Caution: The green wire with the yellow stripe is a ground connection for Electrostatic Discharge (ESD) protection, and should not be removed. To wire the 125V AC plug, consult a licensed electrician and the local building codes in your area.

Appendix B: Setting up a TFTP Server

B.1 Set up a TFTP Server

Autoprovisioning requires a TFTP server for hosting the configuration file.

B.1.1 In a LINUX Environment

To set up a TFTP server on LINUX:

1. Create a directory dedicated to the TFTP server, and move the files to be uploaded to that directory.
2. Run the following command where `/tftpboot/` is the path to the directory you created in [Step 1](#): the directory that contains the files to be uploaded. For example:

```
in.tftpd -l -s /tftpboot/your_directory_name
```

B.1.2 In a Windows Environment

You can find several options online for setting up a Windows TFTP server. This example explains how to use the Solarwinds freeware TFTP server, which you can download at:

<http://www.cyberdata.net/support/voip/solarwinds.html>

To set up a TFTP server on Windows:

1. Install and start the software.
2. Select **File/Configure/Security** tab/**Transmit Only**.
3. Make a note of the default directory name, and then move the firmware files to be uploaded to that directory.

Appendix C: Troubleshooting/Technical Support

C.1 Frequently Asked Questions (FAQ)

To see a list of frequently asked questions for your product, do the following:

1. Go to the following URL:

<http://www.cyberdata.net/products/voip/digitalanalog/loudspeakerampv2/faqs.html>

2. Go to the support page for your product, and click on the **FAQs** tab.

C.2 Documentation

The documentation for this product is released in an English language version only. You can download PDF copies of CyberData product documentation by doing the following:

1. Go to the following URL:

<http://www.cyberdata.net/products/voip/digitalanalog/loudspeakerampv2/docs.html>

2. Go to the support page for your product, and click on the **Documentation** tab.

C.3 Contact Information

Contact	<p>CyberData Corporation 3 Justin Court Monterey, CA 93940 USA www.CyberData.net Phone: 800-CYBERDATA (800-292-3732) Fax: 831-373-4193</p>
Sales	<p>Sales 831-373-2601 Extension 334</p>
Technical Support	<p>The fastest way to get technical support for your VoIP product is to submit a VoIP Technical Support form at the following website:</p> <p>http://www.cyberdata.net/support/contactsupportvoip.php</p> <p>The Support Form initiates a ticket which CyberData uses for tracking customer requests. Most importantly, the Support Form tells us which PBX system and software version that you are using, the make and model of the switch, and other important information. This information is essential for troubleshooting. Please also include as much detail as possible in the Comments section of the Support Form.</p> <p>Phone: (831) 373-2601, Ext. 333 Email: support@cyberdata.net</p>
Returned Materials Authorization	<p>To return the product, contact the Returned Materials Authorization (RMA) department:</p> <p>Phone: 831-373-2601, Extension 136 Email: RMA@CyberData.net</p> <p>When returning a product to CyberData, an approved CyberData RMA number must be printed on the outside of the original shipping package. Also, RMA numbers require an active VoIP Technical Support ticket number. A product will not be accepted for return without an approved RMA number. Send the product, in its original package, to the following address:</p> <p>CyberData Corporation 3 Justin Court Monterey, CA 93940 Attention: RMA "your RMA number"</p>
RMA Status Form	<p>If you need to inquire about the repair status of your product(s), please use the CyberData RMA Status form at the following web address:</p> <p>http://www.cyberdata.net/support/rmastatus.html</p>

C.4 Warranty

CyberData warrants its product against defects in material or workmanship for a period of two years from the date of purchase. Should the product fail Within Warranty, CyberData will repair or replace the product free of charge. This warranty includes all parts and labor.

Should the product fail Out of the Warranty period, a flat rate repair charge of one half of the purchase price of the product will be assessed. Repairs that are Within Warranty period but are damaged by improper installation, modification, or abuse are deemed Out of Warranty and will be charged at the Out of Warranty rate. A device is deemed Out of Warranty when its purchase date is longer than two years or when the device has been damaged due to human error during installation, modification, or abuse. A replacement unit will be offered at full cost if the device cannot be repaired.

End of Life Devices are included under this policy. End of Life devices are devices that are no longer produced or sold. Technical support is still available for these devices. However, no firmware revisions or updates will be provided. If an End of Life device cannot be repaired, the replacement offered may be the current version of the device.

Products shipped to CyberData, both within and out of warranty, are shipped at the expense of the customer. CyberData will pay return shipping charges for repaired products.

CyberData shall not under any circumstances be liable to any person for any special, incidental, indirect or consequential damages, including without limitation, damages resulting from use or malfunction of the products, loss of profits or revenues or costs of replacement goods, even if CyberData is informed in advance of the possibility of such damages.

C.4.1 Warranty & RMA Returns within the United States

If service is required, you must contact CyberData Technical Support prior to returning any products to CyberData. Our Technical Support staff will determine if your product should be returned to us for further inspection. If Technical Support determines that your product needs to be returned to CyberData, an RMA number will be issued to you at this point.

Your issued RMA number must be printed on the outside of the shipping box. No product will be accepted for return without an approved RMA number. The product in its original package should be sent to the following address:

CyberData Corporation

3 Justin Court.

Monterey, CA 93940

Attn: RMA "xxxxxx"

C.4.2 Warranty & RMA Returns outside of the United States

If you purchased your equipment through an authorized international distributor or reseller, please contact them directly for product repairs.

C.4.3 Spare in the Air Policy

CyberData now offers a *Spare in the Air* no wait policy for warranty returns within the United States and Canada. More information about the *Spare in the Air* policy is available at the following web address:

<http://www.cyberdata.net/support/warranty/spareintheair.html>

C.4.4 Return and Restocking Policy

For our authorized distributors and resellers, please refer to your CyberData Service Agreement for information on our return guidelines and procedures.

For End Users, please contact the company that you purchased your equipment from for their return policy.

C.4.5 Warranty and RMA Returns Page

The most recent warranty and RMA information is available at the CyberData Warranty and RMA Returns Page at the following web address:

<http://www.cyberdata.net/support/warranty/index.html>

Index

Symbols

#6 sheet metal screws 64

Numerics

1 speaker configuration 11, 12
 125V AC Plug (wiring) 65
 16 gauge wire 11, 12
 2 speaker configuration 12
 802.3af mode 11, 12
 802.3at mode 12

A

ac plug (wiring) 65
 AC voltages 2
 AC voltages, intercom enclosure is not rated 63
 accessory kit 7
 activate relay (door sensor) 37
 activity LED 18
 address, configuration login 23
 amplified outputs 11, 12
 high power mode 12
 how to use and connect 11
 low power mode 11
 announcing an IP address 19
 audio (buffered) 41
 audio configuration 42
 night ring tone parameter 44
 audio configuration page 42
 audio encodings 4
 audio files, user-created 46
 audio parameters 42
 audio test 19
 audio, buffered 41
 autoprovisioning 55
 autoprovisioned audio files 57
 autoprovisioned firmware upgrades 56
 autoprovisioning autoupdate 56
 autoprovisioning enabled option 55
 autoprovisioning from DHCP 55
 autoprovisioning server (IP address) 56
 networking 55
 autoprovisioning configuration 53, 54

B

backup SIP server 1 32
 backup SIP server 2 32
 backup SIP servers 32
 buffered audio 41

C

cabling 17
 components 10
 configurable parameters 25, 27
 configuration
 default IP settings 21
 door sensor 36
 intrusion sensor 36
 network 29
 SIP 31
 using Web interface 21
 configuration home page 24
 configuration page
 configurable parameters 25, 27
 connecting the amplified outputs 11
 connection options 14
 connections 10, 14
 connections inside of the NEMA box 10
 contact information 68
 contact information for CyberData 68
 Current Network Settings 30
 current network settings 30
 CyberData contact information 68

D

default
 gateway 8, 21
 IP address 8, 21
 subnet mask 8, 21
 username and password 8, 21
 web login username and password 24
 default gateway 8, 21, 30
 default IP settings 21
 default login address 23
 device configuration
 device configuration parameters 54
 the device configuration page 53
 device configuration page 26
 device configuration parameters 27

device parameters, configuration 21, 26
 device, reboot 61
 DHCP Client 4
 DHCP IP addressing 30
 dial out extension (door sensor) 37
 dimensions 5, 6
 DIP switch settings 13
 DIP switches 13
 discovery utility program 23
 distortion, total harmonic 5
 DNS server 30
 door sensor 36, 44

- activate relay 37
- dial out extension 37
- play audio locally 37
- play audio remotely 37

E

enable night ring events 49
 enclosure, mounting 63
 ethernet I/F 5
 event configuration 48

- enable night ring events 49

 event parameter configuration 48
 events 50
 example packets 50
 expiration time for SIP server lease 32, 35

F

factory defaults 9, 19
 firmware

- where to get the latest firmware 58

 firmware upgrade parameters 60
 firmware, upgrading 58

H

harmonic distortion 5
 hazard levels 4
 high power mode (amplified outputs) 12
 home page 23, 24
 http web-based configuration 4

I

identifying your product 1
 illustration of amplifier mounting process 64

input specifications 5
 installation 2
 IP address 8, 21, 30
 IP address announcement 19
 IP address confirmation 19
 IP addressing 30

- default
 - IP addressing setting 8, 21

 IP-PBX server compatibility 31

J

jumper descriptions 16
 jumper locations 16

L

lease, SIP server expiration time 32, 35
 LEDs 18
 lengthy pages 41
 line input specifications 5
 line output specifications 5
 line-in connection 14
 line-in volume settings 20
 link LED 18
 linux DHCPD server setup 56
 Linux, setting up a TFTP server on 66
 local SIP port 32
 log in address 23
 loudspeaker type 17
 loudspeaker, cabling/wiring 17
 low power mode (amplified outputs) 11

M

maximum distance between speakers 12
 maximum wire length for single speaker configuration 11
 maximum wire length for two speaker configuration 12
 MGROUP

- MGROUP Name 40

 mounting an amplifier 64
 multicast 38
 multicast configuration 38
 Multicast IP Address 40

N

navigation (web page) 22
 navigation table 22

NEMA box components 10
 network activity LED 9
 network configuration 29
 network link activity, verifying 18
 network link LED 9
 network setup 29
 nightring tones 41
 Nightringer 34
 Nightringer in peer to peer mode (cannot be used) 34
 nightringer settings 35
 Nightringer, SIP registration required 34
 nightringtones 41

O

one speaker configuration 11, 12
 operating temperature 5
 optional two speaker configuration 12
 outbound proxy 32
 output impedance 5
 output level 5
 output signal amplitudes 5
 output specifications 5

P

packet time 4
 pages (lengthy) 41
 parts list 7
 password

- for SIP server login 32
- login 24
- restoring the default 8, 21

 payload types 5
 play audio locally (door sensor) 37
 play audio remotely (door sensor) 37
 port

- local SIP 32
- remote SIP 32

 power input 5
 power LED 9, 18
 power, connecting to loudspeaker amplifier 11
 priority

- assigning 41

 product

- configuring 21
- mounting 64
- parts list 7

 product features 3
 product overview

- product features 3
- product specifications 5

supported protocols 4
 supported SIP servers 4
 typical system installation 2
 product specifications 5
 protocol 5
 protocols supported 4

R

reboot 60, 61
 registration and expiration, SIP server lease 32
 regulatory compliance 5
 relay connection 14
 remote SIP port 32
 reset test function management switch 19
 resetting the IP address to the default 63
 restoring the factory defaults 9, 19
 return and restocking policy 70
 ringtones 41

- lengthy pages 41

 RMA returned materials authorization 68
 RMA status 68
 RTFM switch 9, 19
 RTP port 33
 RTP/AVP 4

S

safety instructions 5
 sales 68
 sensor

- sensor normally closed 37

 sensor configuration 36
 sensor connection 14
 sensor settings 37
 sensor setup page 36
 sensor setup parameters 36
 server address, SIP 32
 server configuration 31
 service 68
 SIP

- enable SIP operation 32
- local SIP port 32
- user ID 32

 SIP (session initiation protocol) 4
 SIP configuration 31

- SIP Server 32

 SIP configuration parameters

- registration and expiration, SIP server lease 35

 SIP registration 32
 SIP remote SIP port 32
 SIP server 32

- backups 32
- password for login 32
- SIP servers supported 4
- unregister from 32
- user ID for login 32
- SIP server backups 32
- SIP settings 32
- Spare in the Air Policy 70
- speaker cable 17
- speaker configuration 11, 12
- speaker configuration for two speakers 12
- speaker volume setting 20
- speaker wire 17
- standard 1 speaker configuration 11, 12
- static IP addressing 30
- status LED 9, 18
- strobe alert connection 14
- subnet mask 8, 21, 30
- supported protocols 4

T

- tech support 68
- technical support, contact information 68
- test audio 19
- test audio button 27
- TFTP server 4, 66
- two speaker configuration 12

U

- user ID
 - for SIP server login 32
- user ID, SIP 32
- username
 - default for web configuration access 24
 - restoring the default 8, 21
- using the amplified outputs 11

V

- verifying
 - network link and activity 18
 - power on 18
- volume 20
- volume adjustment 19
- volume dial 20
- volume settings 20

W

- warranty 69
- warranty & RMA returns outside of the United States 69
- warranty and RMA returns page 70
- warranty policy at CyberData 69
- web access password 8, 21
- web access username 8, 21
- web configuration log in address 23
- web page
 - navigation 22
- web page navigation 22
- web-based configuration 21
- Windows, setting up a TFTP server on 66
- wire gauge 11, 12
- wire length for single speaker configuration 11
- wire length going to wire nuts for two speaker configuration 12
- wire nuts to connect wire 12
- wiring 17
- wiring (ac plug) 65

X

- xml 50