

# *VoIP Indoor Intercom Operations Guide*

Part #011211\*, RAL 9003, Signal White Color

\*Replaces #011111

*Document Part #930817E  
for Firmware Version 10.3.0*

**CyberData Corporation**  
3 Justin Court  
Monterey, CA 93940  
(831) 373-2601

---

---

**VoIP Indoor Intercom Operations Guide 930817E**  
**Part # 011211\***  
**\*Replaces 011111.**

**COPYRIGHT NOTICE:**

© 2014, CyberData Corporation, ALL RIGHTS RESERVED.

This manual and related materials are the copyrighted property of CyberData Corporation. No part of this manual or related materials may be reproduced or transmitted, in any form or by any means (except for internal use by licensed customers), without prior express written permission of CyberData Corporation. This manual, and the products, software, firmware, and/or hardware described in this manual are the property of CyberData Corporation, provided under the terms of an agreement between CyberData Corporation and recipient of this manual, and their use is subject to that agreement and its terms.

**DISCLAIMER:** Except as expressly and specifically stated in a written agreement executed by CyberData Corporation, CyberData Corporation makes no representation or warranty, express or implied, including any warranty or merchantability or fitness for any purpose, with respect to this manual or the products, software, firmware, and/or hardware described herein, and CyberData Corporation assumes no liability for damages or claims resulting from any use of this manual or such products, software, firmware, and/or hardware. CyberData Corporation reserves the right to make changes, without notice, to this manual and to any such product, software, firmware, and/or hardware.

**OPEN SOURCE STATEMENT:** Certain software components included in CyberData products are subject to the GNU General Public License (GPL) and Lesser GNU General Public License (LGPL) "open source" or "free software" licenses. Some of this Open Source Software may be owned by third parties. Open Source Software is not subject to the terms and conditions of the CyberData COPYRIGHT NOTICE or software licenses. Your right to copy, modify, and distribute any Open Source Software is determined by the terms of the GPL, LGPL, or third party, according to who licenses that software.

Software or firmware developed by CyberData that is unrelated to Open Source Software is copyrighted by CyberData, subject to the terms of CyberData licenses, and may not be copied, modified, reverse-engineered, or otherwise altered without explicit written permission from CyberData Corporation.

**TRADEMARK NOTICE:** CyberData Corporation and the CyberData Corporation logos are trademarks of CyberData Corporation. Other product names, trademarks, and service marks may be the trademarks or registered trademarks of their respective owners.



**Technical Support**

The fastest way to get technical support for your VoIP product is to submit a VoIP Technical Support form at the following website:  
<http://www.cyberdata.net/support/contactsupportvoip.html>

Phone: (831) 373-2601, Ext. 333



Email: [support@cyberdata.net](mailto:support@cyberdata.net)

Fax: (831) 373-4193

Company and product information is at [www.cyberdata.net](http://www.cyberdata.net).

---

## Pictorial Alert Icons

	<p><b>General Alert</b></p> <p>This pictorial alert indicates a potentially hazardous situation. This alert will be followed by a hazard level heading and more specific information about the hazard.</p>
	<p><b>Ground</b></p> <p>This pictorial alert indicates the Earth grounding connection point.</p>

---

## Hazard Levels

**Danger:** Indicates an imminently hazardous situation which, if not avoided, will result in death or serious injury. This is limited to the most extreme situations.

**Warning:** Indicates a potentially hazardous situation which, if not avoided, could result in death or serious injury.

**Caution:** Indicates a potentially hazardous situation which, if not avoided, could result in minor or moderate injury. It may also alert users against unsafe practices.



**Notice:** Indicates a statement of company policy (that is, a safety policy or protection of property).

The safety guidelines for the equipment in this manual do not purport to address all the safety issues of the equipment. It is the responsibility of the user to establish appropriate safety, ergonomic, and health practices and determine the applicability of regulatory limitations prior to use. Potential safety hazards are identified in this manual through the use of words Danger, Warning, and Caution, the specific hazard type, and pictorial alert icons.

---

# Important Safety Instructions

1. Read these instructions.
2. Keep these instructions.
3. Heed all warnings.
4. Follow all instructions.
5. Do not use this apparatus near water.
6. Clean only with dry cloth.
7. Do not block any ventilation openings. Install in accordance with the manufacturer's instructions.
8. Do not install near any heat sources such as radiators, heat registers, stoves, or other apparatus (including amplifiers) that produce heat.
9. Do not defeat the safety purpose of the polarized or grounding-type plug. A polarized plug has two blades with one wider than the other. A grounding type plug has two blades and a third grounding prong. The wide blade or the third prong are provided for your safety. If the provided plug does not fit into your outlet, consult an electrician for replacement of the obsolete outlet.
10. Protect the power cord from being walked on or pinched particularly at plugs, convenience receptacles, and the point where they exit from the apparatus.
11. Only use attachments/accessories specified by the manufacturer.
12. Refer all servicing to qualified service personnel. Servicing is required when the apparatus has been damaged in any way, such as power-supply cord or plug is damaged, liquid has been spilled or objects have fallen into the apparatus, the apparatus has been exposed to rain or moisture, does not operate normally, or has been dropped.
13. Prior to installation, consult local building and electrical code requirements.

 <p>GENERAL ALERT</p>	<p><b>Warning</b></p> <p><i>Electrical Hazard:</i> This product should be installed by a licensed electrician according to all local electrical and building codes.</p>
 <p>GENERAL ALERT</p>	<p><b>Warning</b></p> <p><i>Electrical Hazard:</i> To prevent injury, this apparatus must be securely attached to the floor/wall in accordance with the installation instructions.</p>

---

## Revision Information

Revision 930817E, which was released on September 8, 2014, corresponds to firmware version 10.3.0, and has the following changes:

- Updates [Section 1.3, "Product Features"](#)

---

## Browsers Supported

The following browsers have been tested against firmware version 10.3.0:

- Internet Explorer (version: 10)
- Firefox (also called Mozilla Firefox) (version: 23.0.1 and 25.0)
- Chrome (version: 29.0.1547.66 m)
- Safari (version: 5.1.7)

# Contents

---

<b>Chapter 1 Product Overview</b>	<b>1</b>
1.1 How to Identify This Product .....	1
1.2 Typical System Installation .....	2
1.3 Product Features .....	3
1.4 Supported Protocols .....	4
1.5 Supported SIP Servers .....	4
1.6 Product Specifications .....	5
<b>Chapter 2 Installing the VoIP Indoor Intercom</b>	<b>6</b>
2.1 Parts List .....	6
2.2 Intercom Components .....	7
2.2.1 Call Button and the Call Button LED .....	8
2.3 Intercom Setup .....	9
2.3.1 Intercom Connections .....	9
2.3.2 Using the On-Board Relay .....	10
2.3.3 Wiring the Circuit .....	11
2.3.4 Identifying the VoIP Intercom Connectors .....	13
2.3.5 Activity and Link LEDs .....	15
2.3.6 RTFM Button .....	16
2.3.7 Adjust the Volume .....	17
2.4 Configure the Intercom Parameters .....	18
2.4.1 Factory Default Settings .....	18
2.4.2 Intercom Web Page Navigation .....	19
2.4.3 Log in to the Configuration Home Page .....	20
2.4.4 Configure the Device .....	23
2.4.5 Configure the Network Parameters .....	27
2.4.6 Configure the SIP Parameters .....	29
2.4.7 Configure the Nightringer Parameters .....	34
2.4.8 Configure the Sensor Configuration Parameters .....	36
2.4.9 Configure the Multicast Parameters .....	39
2.4.10 Configure the Audio Configuration Parameters .....	41
2.4.11 Configure the Event Parameters .....	46
2.4.12 Configure the Autoprovisioning Parameters .....	51
2.5 Upgrade the Firmware and Reboot the Intercom .....	59
2.5.1 Uploading the Firmware .....	59
2.5.2 Reboot the Intercom .....	61
2.6 Command Interface .....	62
2.6.1 Command Interface Post Commands .....	62
<b>Appendix A Mounting the Indoor Intercom</b>	<b>66</b>
A.1 Wall Mounting Components .....	66
A.2 Cable Connections .....	67
A.3 Wall Mounting Option .....	68
A.4 Gang Box Option .....	69
A.5 Wall Cutout Dimensions .....	70
A.6 PCB Dimensions .....	71
<b>Appendix B Setting up a TFTP Server</b>	<b>72</b>
B.1 Set up a TFTP Server .....	72
B.1.1 In a LINUX Environment .....	72

B.1.2 In a Windows Environment .....	72
<b>Appendix C Troubleshooting/Technical Support</b>	<b>73</b>
C.1 Frequently Asked Questions (FAQ) .....	73
C.2 Documentation .....	73
C.3 Contact Information .....	74
C.4 Warranty .....	75
C.4.1 Warranty & RMA Returns within the United States .....	75
C.4.2 Warranty & RMA Returns outside of the United States .....	76
C.4.3 Spare in the Air Policy .....	76
C.4.4 Return and Restocking Policy .....	76
C.4.5 Warranty and RMA Returns Page .....	76
 <b>Index</b>	 <b>77</b>

# 1 Product Overview

## 1.1 How to Identify This Product

To identify the VoIP Indoor Intercom, look for a model number label similar to the one shown in [Figure 1-1](#). Confirm the following:

- The model number on the label should be **011211**.
- The serial number on the label should begin with **2111**.

Figure 1-1. Model Number Label

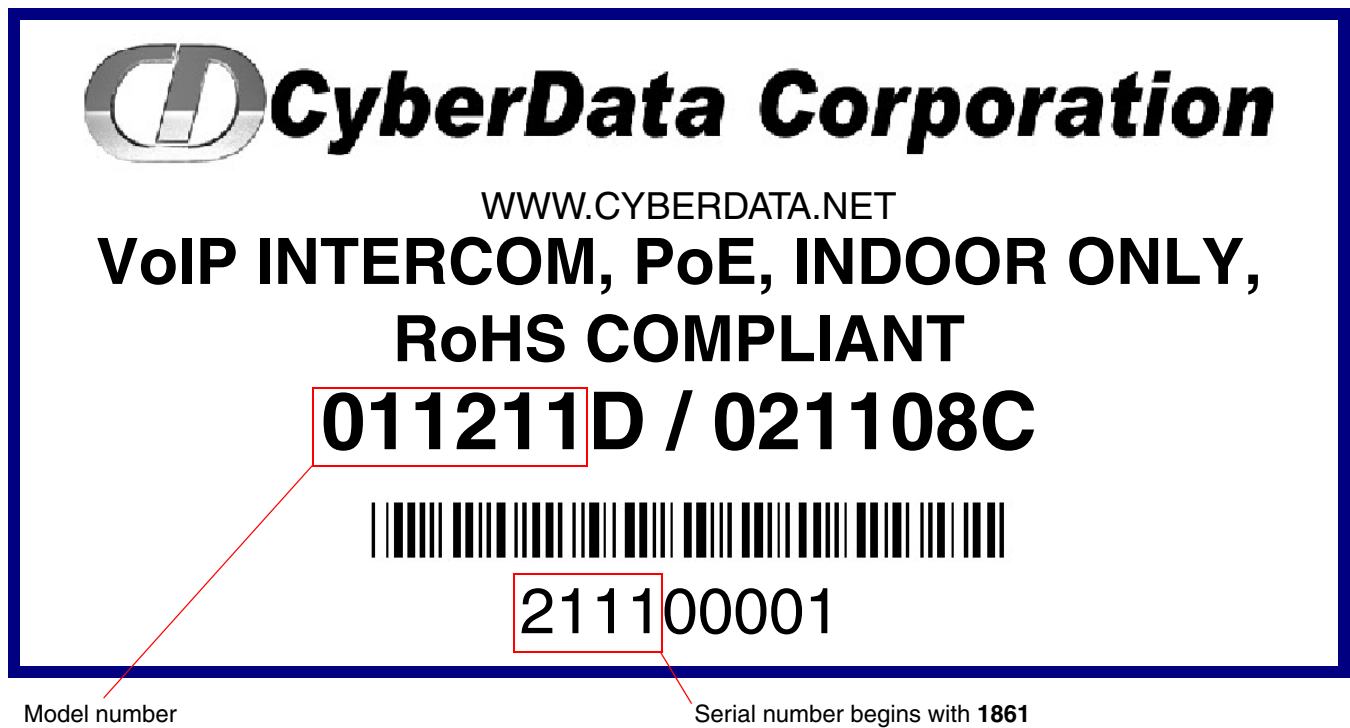



## 1.2 Typical System Installation

The Voice-over-IP (VoIP) VoIP Indoor Intercom is a SIP endpoint designed to provide VoIP phone connectivity in a tamper proof and secure package.

Figure 1-2 illustrates how the VoIP Indoor Intercom can be installed as part of a VoIP phone system.

**Figure 1-2. Typical Installation—Door Entry/Access Control**

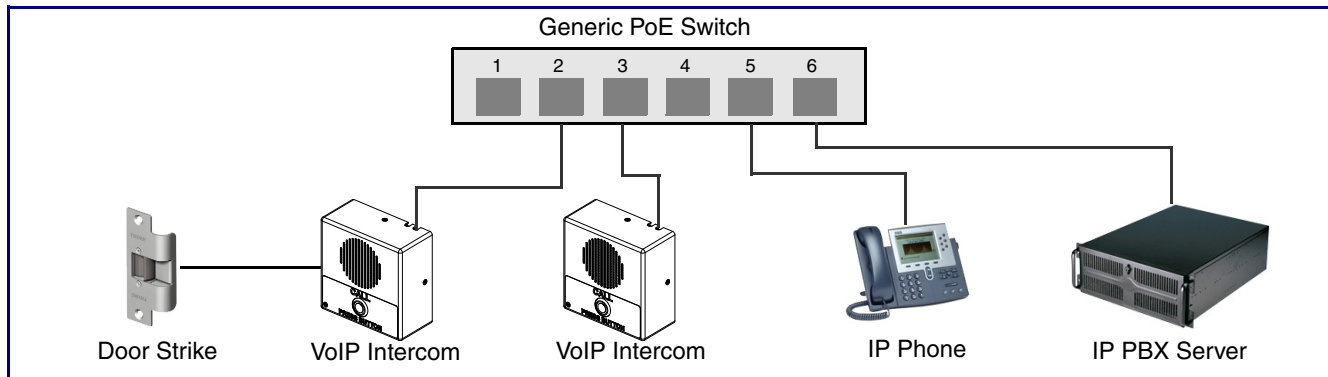

---

## 1.3 Product Features

The VoIP Indoor Intercom has the following features:

- Supports SRST (Survivable Remote Site Telephony) in a Cisco environment. SRST parameters are entered statically into the CyberData product's internal webpage.
- SIP compliant
- Dual speeds of 10 Mbps and 100 Mbps
- PoE 802.3af-enabled (Powered-over-Ethernet)
- Adaptive full duplex voice operation
- Network/Web management
- Network configurable speaker volume
- Network configurable door or intrusion sensor settings
- Network configurable relay activation settings
- Dial out extension supports the addition of comma delimited pauses before sending additional DTMF tones
- Network configurable microphone input sensitivity adjustment
- Network downloadable product firmware
- Doubles as a paging speaker
- Call button
- Call activity indicator (Call Button LED)
- Tamper proof design
- Concurrent SIP and multicast paging
- Dry contact relay for auxiliary control
- Autoprovisioning
- Configurable audio files
- Night Ringer
- Door closure and tamper alert signal
- Peer-to-peer capable

## 1.4 Supported Protocols

The Intercom supports:

- SIP
- HTTP Web-based configuration  
Provides an intuitive user interface for easy system configuration and verification of Intercom operations.
- DHCP Client  
Dynamically assigns IP addresses in addition to the option to use static addressing.
- TFTP Client  
Facilitates hosting for the Autoprovisioning configuration file.
- RTP
- RTP/AVP - Audio Video Profile
- Facilitates autoprovisioning configuration values on boot
- Packet Time 20 ms
- Audio Encodings  
PCMU (G.711 mu-law)  
PCMA (G.711 A-law)

---

## 1.5 Supported SIP Servers

The following link contains information on how to configure the device for the supported SIP servers:

<http://www.cyberdata.net/support/server/index.html>

## 1.6 Product Specifications

**Table 1-1. Specifications**

<b>Category</b>	<b>Specification</b>
Speaker Output	1 Watt Peak Power
Ethernet I/F	10/100 Mbps
Protocol	SIP RFC 3261 Compatible
Power Input	PoE 802.3af compliant or 8 to 12 VDC at 1000 mA
Operating Temperature	-10° C to 50° C (14° F to 122° F)
Payload Types	G711, A-law and $\mu$ -law
Auxiliary Relay	1A at 30 VDC
Dimensions	5.118" x 5.118" x 2.25" (H x W x D)
Weight	0.71 lbs./shipping weight of 1.1 lbs. (0.32 kg/shipping weight of 0.5 kg)
Part Number	011211 <sup>a</sup>



a. This number replaces the 011111 number.

# 2 Installing the VoIP Indoor Intercom

## 2.1 Parts List

Table 2-1 illustrates the VoIP Indoor Intercom parts.

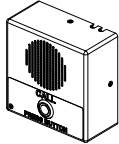
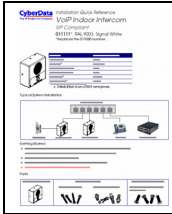
**Table 2-1. Parts List**

Quantity	Part Name	Illustration
1	Intercom Assembly	
1	Installation Quick Reference Guide	
1	Intercom Mounting Accessory Kit	

## 2.2 Intercom Components

Figure 2-1 shows the components of the Intercom.

**Figure 2-1. Intercom Components**

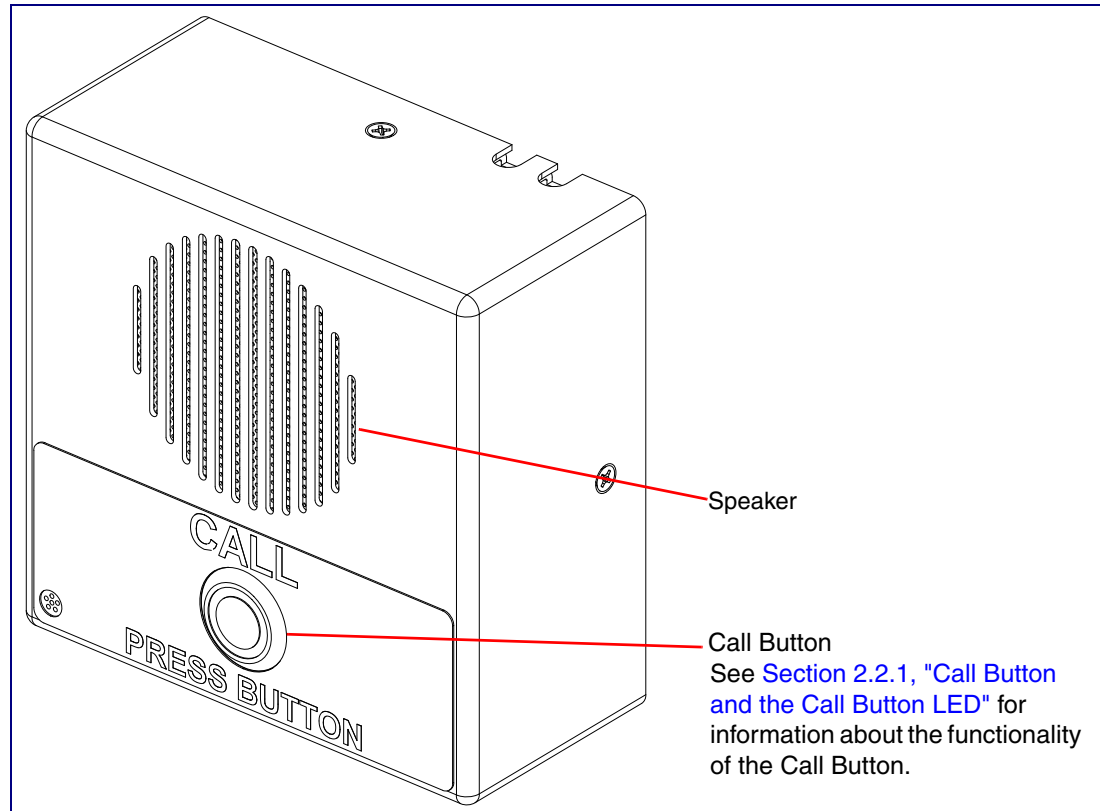

---

## 2.2.1 Call Button and the Call Button LED

### 2.2.1.1 Calling with the The Call Button

- You may initiate a call by pressing the **Call** button.
- An active call is indicated by the Call Button LED blinking at one second intervals.
- The Intercom can automatically answer an incoming call.
- You can press the **Call** button to terminate an active call whether the call was an incoming call or a call that was initiated by you.

### 2.2.1.2 Call Button LED Function

- Upon initial power or reset, the Call Button LED will illuminate.
- When the software has finished initialization, the Call Button LED will blink twice.
- When a call is established (not just ringing), the Call Button LED will blink.
- On the [Device Configuration Page](#), there is an option called **Button Lit When Idle**. This option sets the normal state for the indicator light. The Call Button LED will still blink during initialization and calls.
- The Call Button LED flashes briefly at the beginning of RTFM mode.

**Figure 2-2. Call Button and Call Button LED**

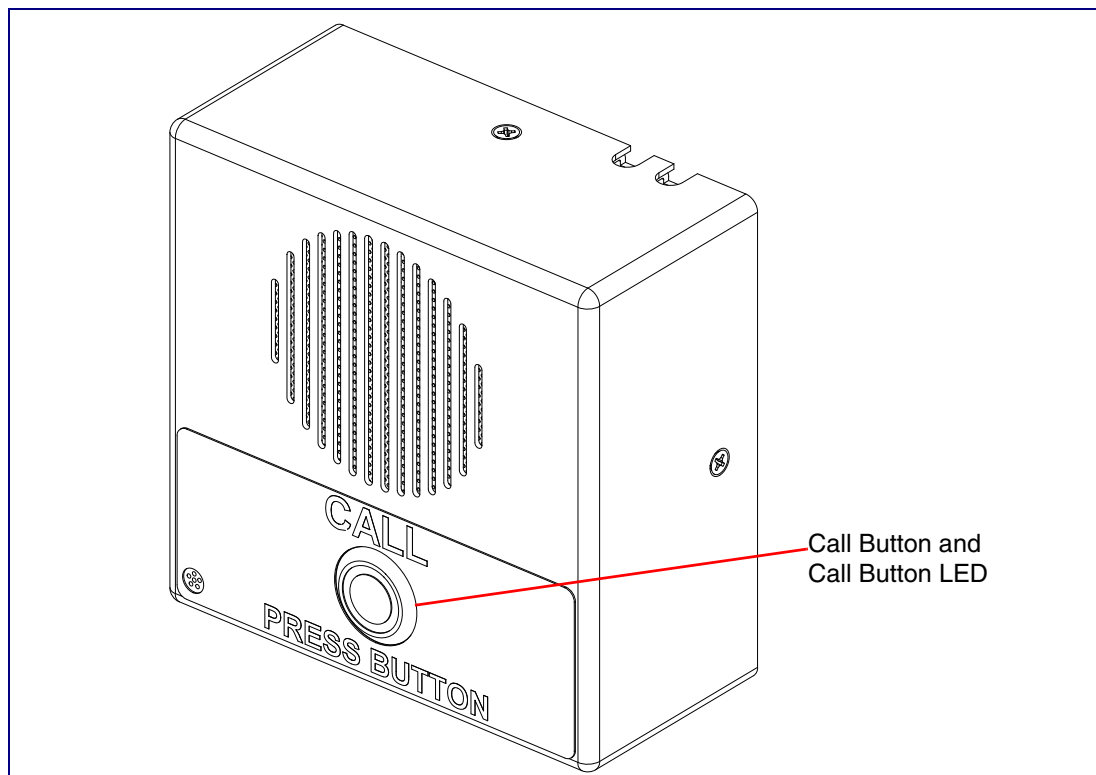

## 2.3 Intercom Setup

### 2.3.1 Intercom Connections

Figure 2-3 shows the pin connections on the J3 (terminal block). This terminal block can accept 16 AWG gauge wire.

**Note** As an alternative to using PoE power, you can supply 8 to 12 VDC at 1000 mA into the terminal block.





 <p>GENERAL ALERT</p>	<p><b>Caution</b></p> <p><i>Equipment Hazard:</i> Contacts 1 and 2 on the J3 terminal block are only for powering the Intercom from a non-PoE 12 VDC power source as an alternative to Network PoE power. Use of these contacts for any other purpose will damage the Intercom and void the product warranty.</p>
--	---

Figure 2-3. Intercom Connections



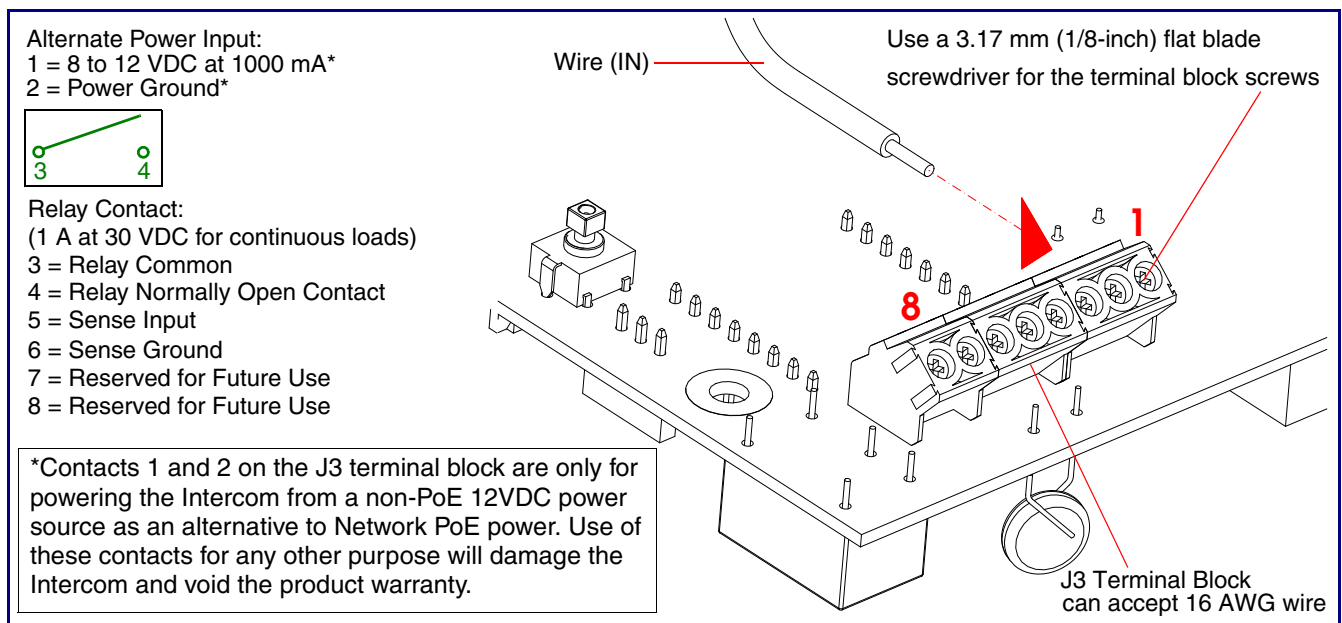

## 2.3.2 Using the On-Board Relay

 <p>GENERAL ALERT</p>	<p><b>Warning</b></p> <p><i>Electrical Hazard:</i> This product should be installed by a licensed electrician according to all local electrical and building codes.</p>
 <p>GENERAL ALERT</p>	<p><b>Warning</b></p> <p><i>Electrical Hazard:</i> The relay contacts are dry and provided for a normally open and momentarily closed configuration. Neither the alternate power input nor PoE power can be used to drive a door strike.</p>
 <p>GENERAL ALERT</p>	<p><b>Warning</b></p> <p><i>Electrical Hazard:</i> The relay does not support AC powered door strikes. Any use of this relay beyond its normal operating range can cause damage to the product and is not covered under our warranty policy.</p>

The device has a built-in relay that can be activated by a web configurable DTMF string that can be received from a VoIP phone supporting out of band (RFC2833) DTMF as well as a number of other triggering events. See the [Device Configuration Page](#) on the web interface for relay settings.

This relay can be used to trigger low current devices like strobes and security camera input signals as long as the load is not an inductive type and the relay is limited to a maximum of 1 Amp @ 30 VDC. Inductive loads have caused excessive “hum” and can interfere with the unit’s electronics.

We highly recommend that inductive load and high current devices use our Door Strike Intermediate Relay product (CD# 011269) (see [Section 2.3.3.2, "Door Strike Intermediate Relay"](#)).

This relay interface also has a general purpose input port that can be used to monitor an external switch and generate an event.

For more information on the sensor options, see the [Sensor Configuration Page](#) on the web interface.

## 2.3.3 Wiring the Circuit

### 2.3.3.1 Devices Less than 1A at 30 VDC

If the power for the device is less than 1A at 30 VDC and is not an inductive load, then see [Figure 2-4](#) for the wiring diagram.

**Figure 2-4. Wiring Diagram**

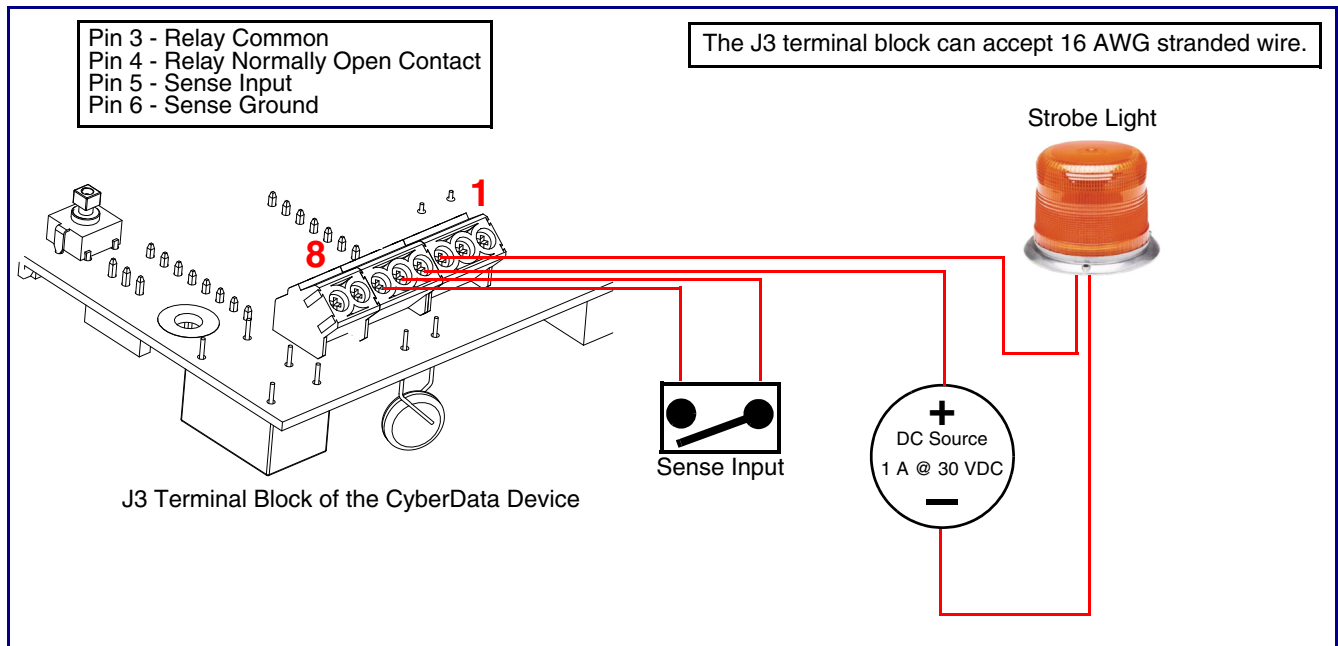

### 2.3.3.2 Door Strike Intermediate Relay

For wiring an electronic door strike, we recommend the use of our external Door Strike Intermediate Relay (CD# 011269).

This product provides an easier method of connecting standard door strikes as well as AC and higher voltage devices. See [Figure 2-5](#) for the wiring diagram.

**Figure 2-5. Wiring Diagram**

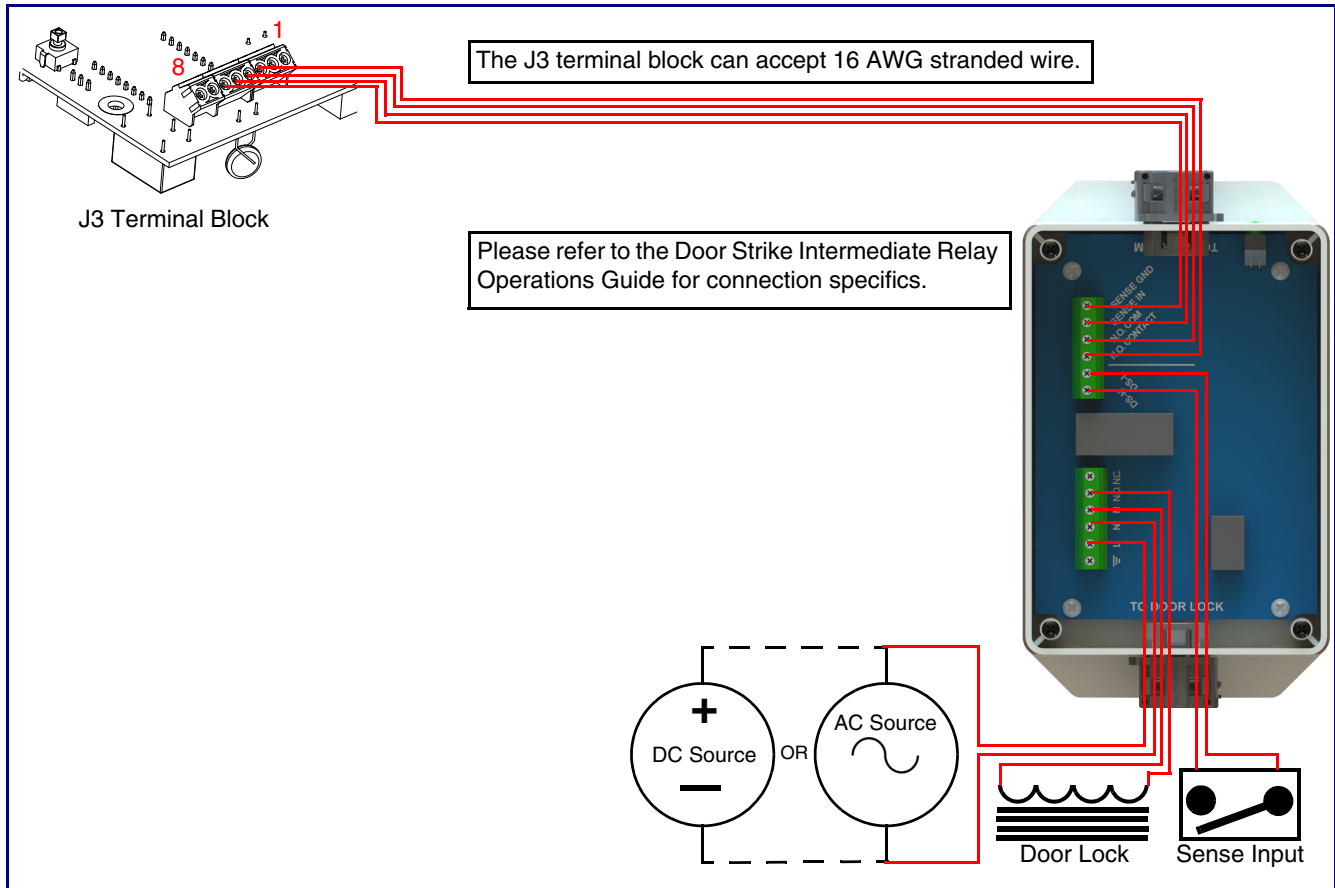

If you have questions about connecting door strikes or setting up the web configurable options, please contact our support department.

<http://www.cyberdata.net/support/voip/index.html>

## 2.3.4 Identifying the VoIP Intercom Connectors

See the following figures and tables to identify the connectors and functions of the Intercom.

**Figure 2-6. Connector Locations**

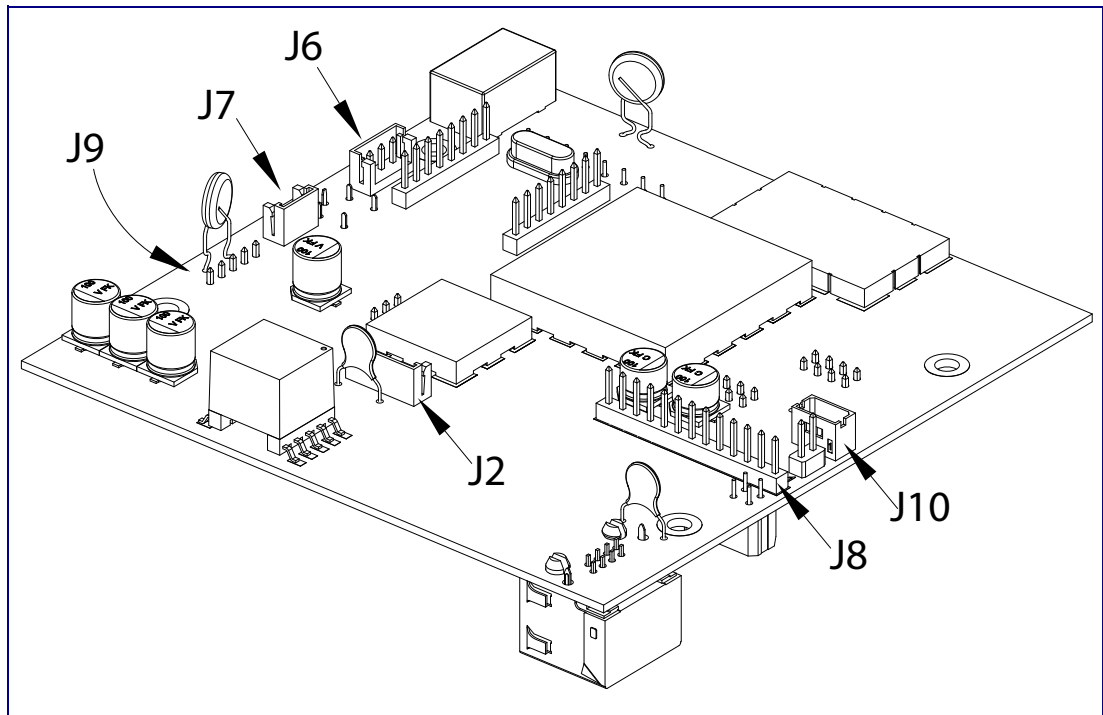

**Table 2-2. Connector Functions**

Connector	Function
J2	Call Button. LED Interface
J6	Microphone Interface
J7	Speaker Interface
J10	Proximity Sensor Interface - N/A
JP10	Disables the intrusion sensor when installed.

**Figure 2-7. Connector Locations**

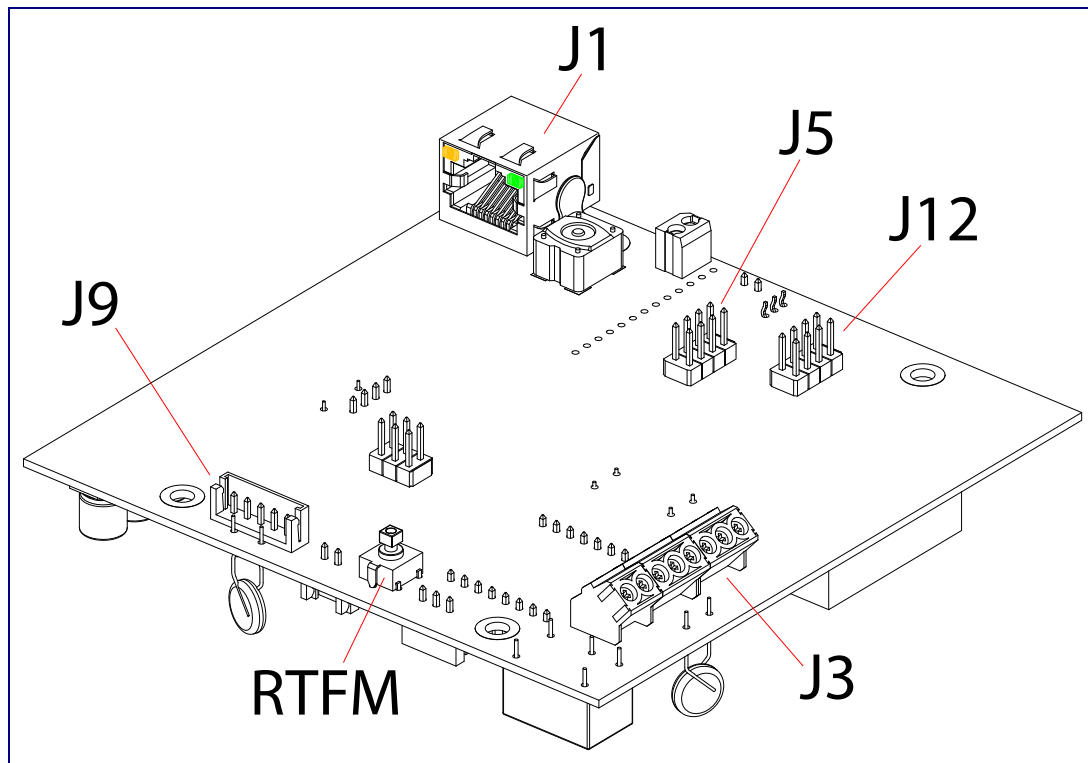

**Table 2-3. Connector Functions**

Connector	Function
JP1	Reset jumper <sup>a</sup>
J1	PoE Network Connection (RJ-45 ethernet)
J3	Terminal Block (see <a href="#">Figure 2-3</a> )
J5	Factory Only—JTAG
J9	Reserved for future use
J12	Reserved for factory diagnostics
RTFM	See <a href="#">Section 2.3.6, "RTFM Button"</a> .

<sup>a</sup>.Do not install a jumper. Momentary short to reset. Permanent installation of a jumper would prevent the board from running all together.

---

## 2.3.5 Activity and Link LEDs

### 2.3.5.1 Verifying the Network Connectivity and Data Rate

When you plug in the Ethernet cable or power supply to the Intercom, the following occurs:

- The square, **YELLOW Activity** light blinks when there is network activity (see [Figure 2-8](#)).
- The square, **GREEN Link** light above the Ethernet port indicates that the network connection has been established (see [Figure 2-8](#)).

**Figure 2-8. Activity and Link LED**

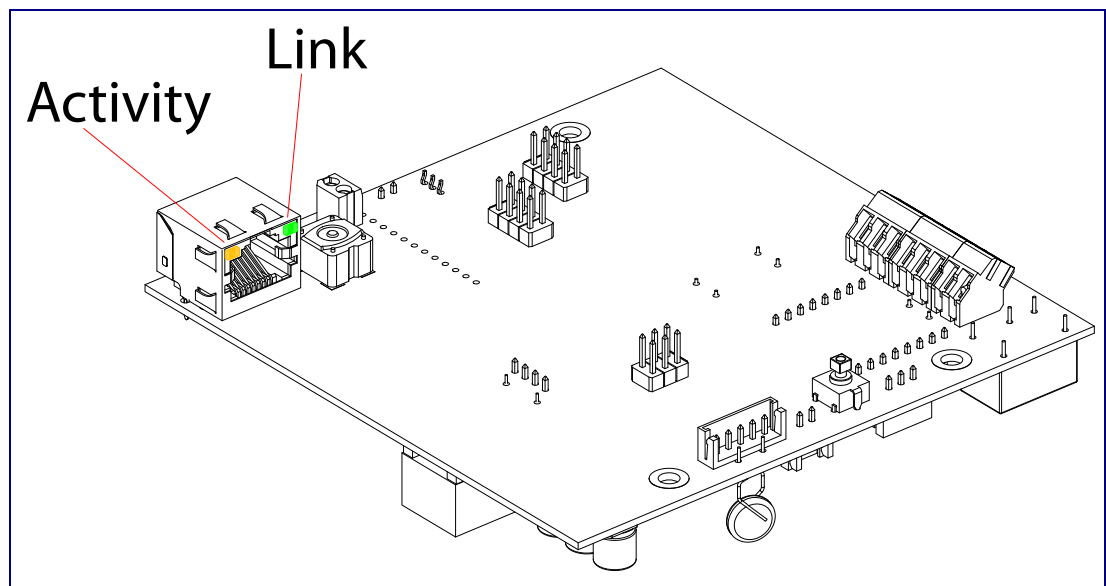

## 2.3.6 RTFM Button

When the Intercom is operational and linked to the network, you can use the Reset Test Function Management (**RTFM**) button (see [Figure 2-9](#)) on the Intercom board to announce and confirm the Intercom's IP Address and test to see if the audio is working.

**Note** You must do these tests prior to final assembly.

**Figure 2-9. RTFM Button (SW1)**

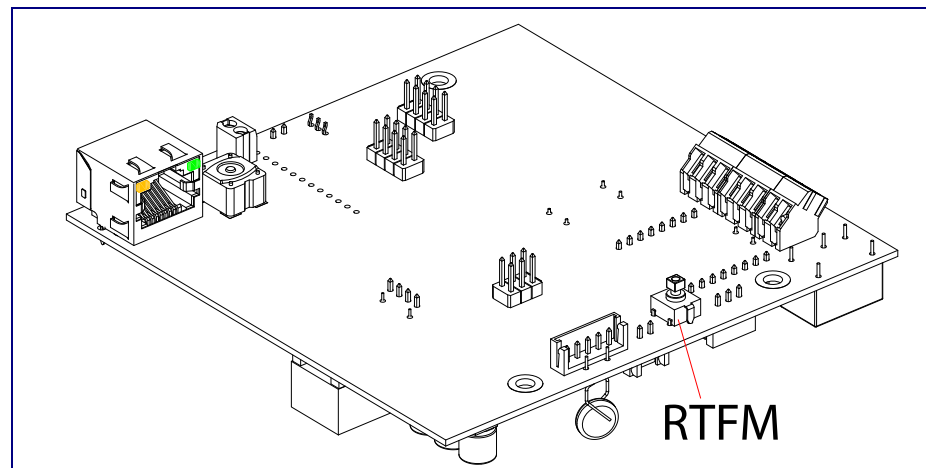

### 2.3.6.1 Announcing the IP Address

To announce a device's current IP address:

1. Press and release the RTFM button (see [Figure 2-10](#)) within a five second window.

**Note** The device will use DHCP to obtain the new IP address (DHCP-assigned address or default to 10.10.10.10 if a DHCP server is not present).

**Note** Pressing and holding the RTFM button for longer than five seconds will restore the device to the factory default settings.

**Figure 2-10. RTFM Button (SW1)**

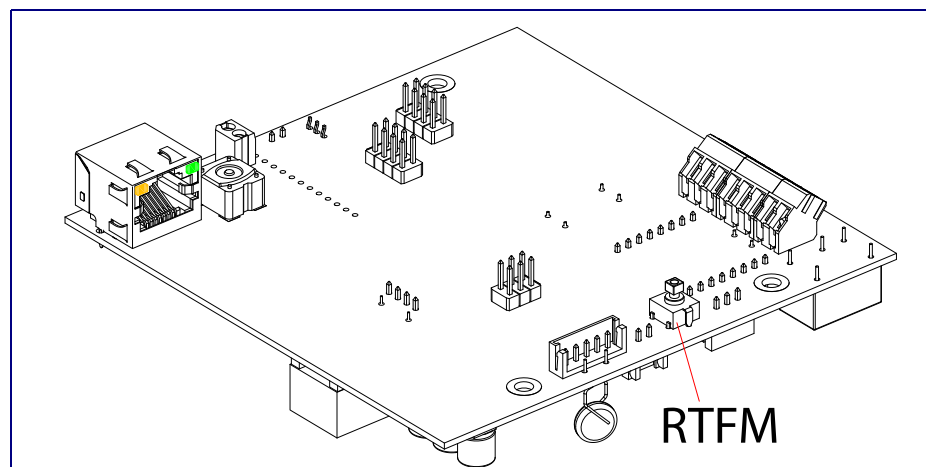

### 2.3.6.2 Restoring the Factory Default Settings

When troubleshooting configuration problems, it is sometimes convenient to restore the device to a known state.

**Note** Each Intercom is delivered with factory set default values.

To restore the factory default settings:

1. Press and hold the **RTFM button** (see **SW1** in [Figure 2-11](#)) for more than five seconds.
2. The device announces that it is restoring the factory default settings.

**Note** The device will use DHCP to obtain the new IP address (DHCP-assigned address or default to 10.10.10.10 if a DHCP server is not present).

**Figure 2-11. RTFM Button**

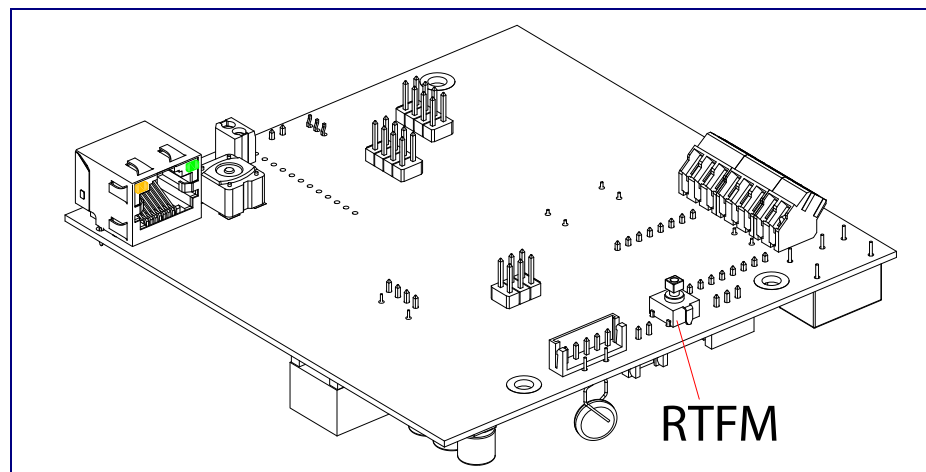

---

### 2.3.7 Adjust the Volume

You can adjust the volume through the [SIP Volume](#), [Multicast Volume](#), [Ring Volume](#), and [Sensor Volume](#) settings on the [Device Configuration Page](#).



---

## 2.4 Configure the Intercom Parameters

To configure the Intercom online, use a standard web browser.

Configure each Intercom and verify its operation *before* you mount it. When you are ready to mount an Intercom, refer to [Appendix A, "Mounting the Indoor Intercom"](#) for instructions.

---

### 2.4.1 Factory Default Settings

All Intercoms are initially configured with the following default IP settings:

When configuring more than one Intercom, attach the Intercoms to the network and configure one at a time to avoid IP address conflicts.

**Table 2-4. Factory Default Settings**

<b>Parameter</b>	<b>Factory Default Setting</b>
IP Addressing	DHCP
IP Address <sup>a</sup>	10.10.10.10
Web Access Username	admin
Web Access Password	admin
Subnet Mask <sup>a</sup>	255.0.0.0
Default Gateway <sup>a</sup>	10.0.0.1











a. Default if there is not a DHCP server present.

---

## 2.4.2 Intercom Web Page Navigation

Table 2-5 shows the navigation buttons that you will see on every Intercom web page.

**Table 2-5. Web Page Navigation**

Web Page Item	Description
	Link to the <b>Home</b> page.
	Link to the <b>Device Configuration</b> page.
	Link to the <b>Networking</b> page.
	Link to go to the <b>SIP Configuration</b> page.
	Link to go to the <b>Nightringer</b> page.
	Link to the <b>Sensor Configuration</b> page.
	Link to the <b>Multicast Configuration</b> page.
	Link to the <b>Audio Configuration</b> page.
	Link to the <b>Event Configuration</b> page.
	Link to the <b>Autoprovisioning Configuration</b> page.
	Link to the <b>Update Firmware</b> page.

---

## 2.4.3 Log in to the Configuration Home Page

1. Open your browser to the Intercom IP address.

**Note** If the network does not have access to a DHCP server, the device will default to an IP address of 10.10.10.10.

**Note** Make sure that the PC is on the same IP network as the Intercom.

**Note** You may also download CyberData's VoIP Discovery Utility program which allows you to easily find and configure the default web address of the CyberData VoIP products.

CyberData's VoIP Discovery Utility program is available at the following website address:

<http://www.cyberdata.net/support/voip/discovery.html>

**Note** The Intercom ships in DHCP mode. To get to the **Home** page, use the discovery utility to scan for the device on the network and open your browser from there.

2. When prompted, use the following default **Web Access Username** and **Web Access Password** to access the **Home Page** (Figure 2-12):

Web Access Username: **admin**

Web Access Password: **admin**

Figure 2-12. Home Page

# CyberData Indoor Intercom

- Home
- Device Config
- Networking
- SIP Config
- Nightringer
- Sensor Config
- Multicast Config
- Audio Config
- Event Config
- Autoprovisioning
- Update Firmware

### Device Settings

Device Name:

Change Username:

Change Password:

Re-enter Password:

### Current Settings

Serial Number: 211100000  
Mac Address: 00:20:f7:02:34:9c  
Firmware Version: v10.3.0

IP Addressing: dhcp  
IP Address: 192.168.70.82  
Subnet Mask: 255.255.240.0  
Default Gateway: 192.168.64.1  
DNS Server 1: 192.168.65.20  
DNS Server 2: 192.168.65.10

Speaker Volume: 4  
Microphone Gain: 4

SIP Mode is: enabled  
Multicast Mode is: disabled  
Event Reporting is: disabled  
Nightringer is: disabled (NOT Registered with SIP Server)

Primary SIP Server: (NOT Registered with SIP Server)  
Backup Server 1: (NOT Registered with SIP Server)  
Backup Server 2: (NOT Registered with SIP Server)



### Import/Export Settings

Please specify a configuration file\*:  
 No file selected.

\* You need to reboot for changes to take effect

3. On the **Home Page**, review the setup details and navigation buttons described in [Table 2-6](#).

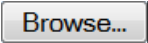
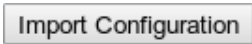
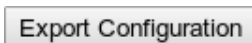
**Table 2-6. Home Page Overview**

Web Page Item	Description
<b>Device Settings</b>	
Device Name	Shows the device name.
Change Username	Type in this field to change the username.
Change Password	Type in this field to change the password.
Re-enter Password	Type the password again in this field to confirm the new password.
<b>Current Settings</b>	
Serial Number	Shows the device serial number.
Mac Address	Shows the device Mac address.
Firmware Version	Shows the current firmware version.
IP Addressing	Shows the current IP addressing setting ( <b>DHCP</b> or <b>static</b> ).
IP Address	Shows the current IP address.
Subnet Mask	Shows the current subnet mask address.
Default Gateway	Shows the current default gateway address.
DNS Server 1	Shows the current DNS Server 1 address.
DNS Server 2	Shows the current DNS Server 2 address.
Speaker Volume	Shows the current speaker volume level.
Microphone Gain	Shows the current microphone gain level.
SIP Mode is	Shows the current status of the SIP mode.
Multicast Mode is	Shows the current status of the Multicast mode.
Event Reporting is	Shows the current status of the Event Reporting mode.
Nightringer is	Shows the current status of the Nightringer mode.
Primary SIP Server	Shows the current status of the Primary SIP Server.
Backup Server 1	Shows the current status of Backup Server 1.
Backup Server 2	Shows the current status of Backup Server 2.
<b>Import/Export Settings</b>	
	Press the <b>Browse</b> button to select a configuration file to import.
	Press the <b>Import Configuration</b> button to save a board configuration to the board. <b>Note:</b> The board will have to be reset before changes will take effect.
	Press the <b>Export Configuration</b> button to download the current board configuration.
	Click the <b>Save</b> button to save your configuration settings. <b>Note:</b> You need to reboot for changes to take effect.
	Click on the <b>Reboot</b> button to reboot the system.

## 2.4.4 Configure the Device

1. Click the **Device Configuration** button to open the **Device Configuration** page. See [Figure 2-13](#).

Figure 2-13. Device Configuration Page

**CyberData Indoor Intercom**

**Device Configuration**

Home  
**Device Config**  
 Networking  
 SIP Config  
 Nightringer  
 Sensor Config  
 Multicast Config  
 Audio Config  
 Event Config  
 Autoprovisioning  
 Update Firmware

**Volume Settings**

SIP Volume: 4  
 Multicast Volume: 4  
 Ring Volume: 4  
 Sensor Volume: 4  
 Microphone Gain: 4  
 No Volume Boost ▾  
 Boost operation recommended with volumes set to level 9

**Relay Settings**

Activate Relay with DTMF code:   
 DTMF Activation Code: 321  
 DTMF Activation Duration (in seconds): 2  
 Play tone during DTMF Activation:   
 Activate Relay During Ring:   
 Activate Relay During Night Ring:   
 Activate Relay While Call Active:   
 Activate Relay on Button Press:   
 Relay on Button Press Timeout (in seconds): 3

**Miscellaneous Settings**

Auto-Answer Incoming Calls:   
 Button Lit when Idle:   
 Button Brightness (0-255): 255  
 Play Ringback Tone:   
 Enable Push to Talk:

\* You need to reboot for changes to take effect

Save Test Audio Test Microphone Test Relay Reboot

2. On the **Device Configuration** page, you may enter values for the parameters indicated in [Table 2-7](#).

**Table 2-7. Device Configuration Parameters**

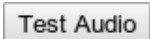
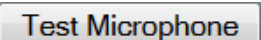

Web Page Item	Description
<b>Volume Settings</b>	
SIP Volume	Type the desired SIP volume level into this field.
Multicast Volume	Type the desired Multicast volume level into this field.
Ring Volume	Type the desired Ring volume level into this field.
Sensor Volume	Type the desired Sensor volume level into this field.
Microphone Gain	Type the desired microphone gain level into this field.
No Volume Boost	<p>Normal operation of the product can be met with volume levels <b>0</b> through <b>9</b>. <b>0</b> being mute and <b>9</b> being the loudest volume that in a normal arm's length and average background noise, will enable full duplex operation and give the best quality of sound output.</p> <p>The volume boost options increase the output of the speaker by:</p> <p>3db for Boost level 1                      6db for Boost level 2                      9db for Boost level 3</p> <p>If the user would like a higher output from the speaker, the Boost settings are available. However, operation in <b>Boost Mode</b> may overdrive or clip the audio if, for example, the phone that is connected has a high microphone gain or if the person has a loud voice talking too close to the microphone.</p> <p>The acoustic echo canceller also has a harder time maintaining full duplex operation when in the <b>Boost Mode</b>. The product may drop from full duplex operation into half/duplex mode while in <b>Boost Mode</b>.</p> <p>Contact CyberData support for additional information if needed.</p>
Volume Boost 1	
Volume Boost 2	
Volume Boost 3	
<b>Relay Settings</b>	
Activate Relay with DTMF Code	When selected, the relay can be activated with a DTMF code.
DTMF Activation Code	Type the desired DTMF activation code (25 character limit).
DTMF Activation Duration (in seconds)	Type the desired DTMF activation duration (in seconds) (2 character limit [activation times now go up to 99 seconds]).  <b>NOTE:</b> A DTMF activation duration of <b>0</b> will toggle the relay indefinitely or until the activation code is sent again
Play tone during DTMF Activation	When selected, the device will play a tone when the relay is activated with a DTMF code.

**Table 2-7. Device Configuration Parameters (continued)**

Web Page Item	Description
Activate Relay During Ring	When selected, the relay will be activated for as long as the call is active.  <b>NOTE:</b> When the phone is set to <b>Auto Answer</b> , it will not ring and this option does nothing.
Activate Relay During Night Ring	Check this box to activate the relay for as long as a Night Ring tone is ringing.
Activate Relay While Call Active	When selected, the relay will be activated for as long as the call is active.
Activate Relay on Button Press	When selected, the relay will be activated when the Call Button is pressed.
Relay on Button Press Timeout (in seconds)	Type the desired time (in seconds) that you want the relay to activate after the Call Button is pressed (1 character limit).
<b>Miscellaneous Settings</b>	
Auto-Answer Incoming Calls	When selected, the device will automatically answer incoming calls.  When <b>Auto Answer</b> is Off, the device will play a ringtone through the Intercom speaker until someone presses the button.
Button Lit When Idle	When selected, the Call Button remains lit when idle.
Button Brightness (0-255)	Type the desired Call Button LED brightness level (0-255).
Play Ringback Tone	When selected, you will hear a ringback tone while making a call.
Enable Push to Talk	This option is for noisy environments. When enabled, the microphone will be muted normally. When the button is pressed and held, it will unmute the microphone and allow the operator to send audio back.  <b>NOTE:</b> When <b>Enable Push to Talk</b> is enabled, you cannot stop an active call with the call button. The device on the other end will need to end the call.  <b>NOTE:</b> <b>Enable Push to Talk</b> will not work on some older hardware.
	Click the <b>Save</b> button to save your configuration settings.  <b>Note:</b> You need to reboot for changes to take effect.
	Click on the <b>Test Audio</b> button to do an audio test. When the <b>Test Audio</b> button is pressed, you will hear a voice message for testing the device audio quality and volume.
	Click on the <b>Test Microphone</b> button to do a microphone test. When the <b>Test Microphone</b> button is pressed, the following occurs:  1. The device will immediately start recording 3 seconds of audio.  2. The device will beep (indicating the end of recording).  3. The device will play back the recorded audio.



**Table 2-7. Device Configuration Parameters (continued)**

Web Page Item	Description
	Click on the <b>Test Relay</b> button to do a relay test.
	Click on the <b>Reboot</b> button to reboot the system.

**Note** You can change the **SIP Volume**, **Multicast Volume**, **Ring Volume**, **Sensor Volume**, and **Microphone Gain** without rebooting the device. You must save and reboot the device for other changes to take effect.

## 2.4.5 Configure the Network Parameters

1. Click the **Networking** button to open the **Network Configuration** page (Figure 2-14).

Figure 2-14. Network Configuration Page

**CyberData Indoor Intercom**

**Home** **Network Configuration**

**Device Config**

**Networking**

**SIP Config**

**Nightringer**

**Sensor Config**

**Multicast Config**

**Audio Config**

**Event Config**

**Autoprovisioning**

**Update Firmware**

Stored Network Settings

IP Addressing:  Static  DHCP

IP Address: 10.10.10.10

Subnet Mask: 255.0.0.0

Default Gateway: 10.0.0.1

DNS Server 1: 10.0.0.1

DNS Server 2: 10.0.0.1

Hostname: SipDevice023614

VLAN ID (0-4095): 0

VLAN Priority (0-7): 0

DHCP Timeout

DHCP Timeout in seconds\*: 60



\* A value of -1 will retry forever

\* You need to reboot for changes to take effect

Save Reboot

2. On the **Network Configuration** page, enter values for the parameters indicated in [Table 2-8](#).

**Table 2-8. Network Configuration Parameters**

Web Page Item	Description
<b>Stored Network Settings</b>	
IP Addressing	Select either <b>DHCP IP Addressing</b> or <b>Static IP Addressing</b> by marking the appropriate radio button. If you select <b>Static</b> , configure the remaining parameters indicated in <a href="#">Table 2-8</a> . If you select <b>DHCP</b> , go to <a href="#">Step Note</a> .
IP Address	Enter the Static IP address.
Subnet Mask	Enter the Subnet Mask address.
Default Gateway	Enter the Default Gateway address.
DNS Server 1	Enter the DNS Server 1 address.
DNS Server 2	Enter the DNS Server 2 address.
Hostname	This is the hostname provided to the DHCP server. This can be used in conjunction with a DNS server to address the device by host name instead of by IP address. Check your DHCP server and DNS server documentation for more information.
VLAN ID (0-4095)	Enter the VLAN ID number.  <b>Note:</b> The device supports 802.11Q VLAN tagging support. The switch port connected to the device will need to be in “trunking mode” for the VLAN tags to propagate.
VLAN Priority (0-7)	Enter the VLAN priority number.
<b>DHCP Timeout</b>	
DHCP Timeout in seconds	Enter the desired timeout duration (in seconds) that the device will wait for a response from the DHCP server before defaulting back to the stored static IP address.  <b>Note:</b> A value of <b>-1</b> will cause the device to retry indefinitely and a value of <b>0</b> will cause the device to reset to a default of 60 seconds.
	Click the <b>Save</b> button to save your configuration settings.  <b>Note:</b> You need to reboot for changes to take effect.
	Click on the <b>Reboot</b> button to reboot the system.

**Note** You must click on the **Save** button and then the **Reboot** button for the changes to take effect.

## 2.4.6 Configure the SIP Parameters

1. Click **SIP Config** to open the **SIP Configuration** page (Figure 2-15).

**Note** For specific server configurations, go to the following website address:

<http://www.cyberdata.net/support/server/index.html>

Figure 2-15. SIP Configuration Page

**CyberData Indoor Intercom**

**SIP Configuration**

Enable SIP operation:

**SIP Settings**

Primary SIP Server (NOT Registered): 10.0.0.253  
Primary SIP User ID: 199  
Primary SIP Auth ID: 199  
Primary SIP Auth Password: ●●●●●●

Backup SIP Server 1 (NOT Registered):  
Backup SIP User ID 1:  
Backup SIP Auth ID 1:  
Backup SIP Auth Password 1:

Backup SIP Server 2 (NOT Registered):  
Backup SIP User ID 2:  
Backup SIP Auth ID 2:  
Backup SIP Auth Password 2:

Use Cisco SRST:

Remote SIP Port: 5060  
Local SIP Port: 5060  
Outbound Proxy:  
Outbound Proxy Port: 0

Register with a SIP Server:   
Re-registration Interval (in seconds): 360  
NAT ping (check box if PBX is not local):   
Disable rport Discovery:

**Call disconnection**

Terminate call after delay (in seconds): 0  
Note: A value of 0 will disable this function

**RTP Settings**

RTP Port (even): 10500

**Dial Out Settings**

Dial out Extension: 204  
Extension ID: id204

\* You need to reboot for changes to take effect



Save Reboot

2. On the **SIP Configuration** page, enter values for the parameters indicated in [Table 2-9](#).

**Table 2-9. SIP Configuration Parameters**

Web Page Item	Description
Enable SIP Operation	Enables or disables SIP operation.
<b>SIP Settings</b>	
Primary SIP Server [registration status]	Use this field to set the address (in dotted decimal notation or as a canonical name) for the Primary SIP Server. This field can accept canonical names of up to 255 characters in length.
Primary SIP User ID	Type the <b>SIP User ID</b> for the Primary SIP Server (up to 64 alphanumeric characters).
Primary SIP Auth ID	Type the <b>Authenticate ID</b> for the Primary SIP Server (up to 64 alphanumeric characters).
Primary SIP Auth Password	Type the <b>Authenticate Password</b> for the Primary SIP Server (up to 64 alphanumeric characters).
Backup SIP Server 1 Backup SIP Server 2	<ul style="list-style-type: none"> <li>• If all of the <b>Primary SIP Server</b> and <b>Backup SIP Server</b> fields are populated, the device will attempt to stay registered with all three servers all of the time. You can leave the <b>Backup SIP Server 1</b> and <b>Backup SIP Server 2</b> fields blank if they are not needed.</li> <li>• In the event of a registration failure on the <b>Primary SIP Server</b>, the device will use the next highest priority server for outbound calls (<b>Backup SIP Server 1</b>). If <b>Backup SIP Server 1</b> fails, the device will use <b>Backup SIP Server 2</b>.</li> <li>• If a higher priority SIP Server comes back online, the device will switch back to this server.</li> </ul>
Backup SIP User ID 1 Backup SIP User ID 2	Type the <b>SIP User ID</b> for the Backup SIP Server (up to 64 alphanumeric characters).
Backup SIP Auth ID 1 Backup SIP Auth ID 2	Type the <b>SIP Authenticate ID</b> for the Backup SIP Server (up to 64 alphanumeric characters).
Backup SIP Auth Password 1 Backup SIP Auth Password 2	Type the <b>SIP Authenticate Password</b> for the Backup SIP Server (up to 64 alphanumeric characters).
Use Cisco SRST	When selected, the backup servers are handled according to Cisco SRST (Survivable Remote Site Telephony).
Remote SIP Port	Type the <b>Remote SIP Port</b> number (default 5060) (8 character limit).
Local SIP Port	Type the <b>Local SIP Port</b> number (default 5060) (8 character limit).
Outbound Proxy	Type the Outbound Proxy as either a numeric IP address in dotted decimal notation or the fully qualified host name (255 character limit [FQDN]).
Outbound Proxy Port	Type the Outbound Proxy Port number (8 character limit).
Register with a SIP Server	<p>Check this box to enable SIP Registration.</p> <p>For information about Point-to-Point Configuration, see <a href="#">Section 2.4.6.2, "Point-to-Point Configuration"</a>.</p>
Re-registration Interval (in seconds)	The SIP Registration lease time in seconds.

**Table 2-9. SIP Configuration Parameters (continued)**

Web Page Item	Description
NAT ping (check box if PBX is not local)	Check this box if the PBX server is remote and you are experiencing problems establishing calls with the PBX.
Disable rport Discovery	Check this box prevent the device from including the public WAN IP address in the contact information that is sent to the remote SIP servers. This will generally only need to be enabled when using an SBC in conjunction with a remote SIP server.
<b>Call Disconnection</b>	
Terminate call after delay (in seconds)	Type the desired number of seconds that you want to transpire after a connection delay before a call is terminated.  Note: A value of <b>0</b> will disable this function.
<b>RTP Settings</b>	
RTP Port (even)	Specify the port number used for the RTP stream after establishing a SIP call. This port number has to be an even number and defaults to 10500.
<b>Dial Out Settings</b>	
Dial Out Extension	Type the dial out extension number (64 character limit).  <b>Note:</b> For information about dial-out extension strings and DTMF tones, see <a href="#">Section 2.4.6.1, "Dial Out Extension Strings and DTMF Tones (using rfc2833)"</a> .
Extension ID	Type the desired Extension ID (64 character limit).
	Click the <b>Save</b> button to save your configuration settings.  <b>Note:</b> You need to reboot for changes to take effect.
	Click on the <b>Reboot</b> button to reboot the system.

**Note** You must click on the **Save** button and then the **Reboot** button for the changes to take effect.

### 2.4.6.1 Dial Out Extension Strings and DTMF Tones (using rfc2833)

On the [SIP Configuration Page](#), dial out extensions support the addition of comma delimited pauses and sending additional DTMF tones (using rfc2833). The first comma will pause three seconds after a call is first established with a remote device. Subsequent commas will pause for 2 seconds. A pause of one second will be sent after each numerical digit.

**Table 2-10. Examples of Dial-Out Extension Strings**

Extension String	Resulting Action
302	Dial out extension 302 and establish a call
302,2	Dial out extension 302 and establish a call, wait 3 seconds then send the DTMF tone '2'
302,25,,,4,,1	Dial out extension 302 and establish a call, wait 3 seconds then send the DTMF tone '2', send out DTMF tone 5, wait 6 seconds, send out DTMF tone 4, wait 4 seconds, send out DTMF tone 1

**Note** The maximum number of total characters in the dial-out field is 64.

## 2.4.6.2 Point-to-Point Configuration

When the board is set to not register with a SIP server (see [Figure 2-16](#)), it's possible to set the intercom to dial out to a single endpoint.

In this case, the dial-out extension should be the IP address of the remote device. The Intercom can also receive Point-to-Point calls. The delayed DTMF functionality is available in the Point-to-Point Mode.

**Note** Receiving point-to-point SIP calls may not work with all phones.

**Figure 2-16. SIP Configuration Page Set to Point-to-Point Mode**

Intercom is set to NOT register with a SIP server

### 2.4.6.3 Delayed DTMF

On the **SIP Configuration** page the dial out extension supports the addition of comma delimited pauses and sending additional DTMF tones (using rfc2833). The first comma will pause three seconds after a call is first established with a remote device. Subsequent commas will pause for 2 seconds. A pause of one second will be sent after each numerical digit.

**Table 2-11. Examples of Dial-Out Extension Strings**

<b>Extension String</b>	<b>Resulting Action</b>
302	Dial out extension 302 and establish a call
302,2	Dial out extension 302 and establish a call, wait 3 seconds then send the DTMF tone '2'
302,25,,,4,,1	Dial out extension 302 and establish a call, wait 3 seconds then send the DTMF tone '2', send out DTMF tone 5, wait 6 seconds, send out DTMF tone 4, wait 4 seconds, send out DTMF tone 1

**Note** The maximum number of total characters in the dial-out field is 25.



## 2.4.7 Configure the Nightringer Parameters

When the Nightringer is enabled, the Intercom will register as a second SIP extension. Registration does not have to be to the same server as the primary SIP registration. Any calls made to the Nightringer extension will cause the Intercom to play a ring tone. There is no way to answer this call. The Nightringer is designed to be used in buildings where calls made after hours are directed to a ring group.

 <small>GENERAL ALERT</small>	<p><b>Caution</b></p> <p>Nightringer requires SIP Registration. Nightringer cannot be used in peer to peer mode.</p>
---	--

1. Click on the **Nightringer** button to open the **Nightringer Configuration** page. See [Figure 2-17](#).

**Figure 2-17. Nightringer Configuration Setup**

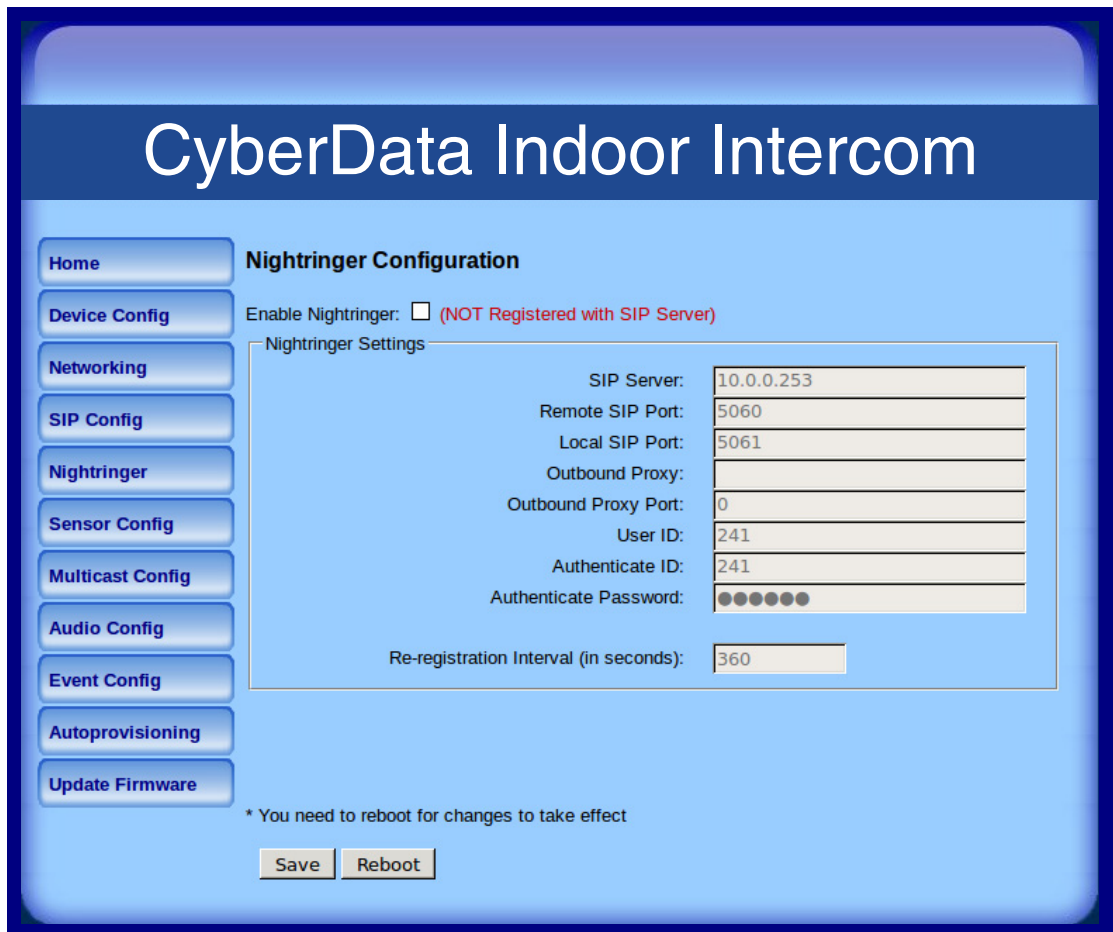

# CyberData Indoor Intercom

- Home
- Device Config
- Networking
- SIP Config
- Nightringer
- Sensor Config
- Multicast Config
- Audio Config
- Event Config
- Autoprovisioning
- Update Firmware

## Nightringer Configuration

Enable Nightringer:  (NOT Registered with SIP Server)

**Nightringer Settings**



SIP Server:	10.0.0.253
Remote SIP Port:	5060
Local SIP Port:	5061
Outbound Proxy:	
Outbound Proxy Port:	0
User ID:	241
Authenticate ID:	241
Authenticate Password:	●●●●●●

Re-registration Interval (in seconds):

\* You need to reboot for changes to take effect

2. On the **Nightringer Configuration** page, enter values for the parameters indicated in [Table 2-12](#).

**Table 2-12. Nightringer Configuration Parameters**

Web Page Item	Description
Enable Nightringer	When the nightringer is enabled, the unit will attempt to register a second extension with the SIP server. Any calls made to this extension will play a ringtone.
<b>Nightringer Settings</b>	
SIP Server	Type the SIP server represented as either a numeric IP address in dotted decimal notation.
Remote SIP Port	Type the Remote SIP Port number (default 5060) (8 character limit).
Local SIP Port	Type the Local SIP Port number (default 5060) (8 character limit). <b>Note:</b> This value cannot be the same as the <a href="#">Local SIP Port</a> found on the <a href="#">SIP Configuration Page</a> .
Outbound Proxy	Type the Outbound Proxy as either a numeric IP address in dotted decimal notation or the fully qualified host name (255 character limit [FQDN]).
Outbound Proxy Port	Type the Outbound Proxy Port number (8 character limit).
User ID	Type the <b>User ID</b> (up to 64 alphanumeric characters).
Authenticate ID	Type the <b>Authenticate ID</b> (up to 64 alphanumeric characters).
Authenticate Password	Type the <b>Authenticate Password</b> (up to 64 alphanumeric characters).
Re-registration Interval (in seconds)	The SIP Registration lease time (in seconds).
	Click the <b>Save</b> button to save your configuration settings. <b>Note:</b> You need to reboot for changes to take effect.
	Click on the <b>Reboot</b> button to reboot the system.

**Note** You must click on the **Save** button and then the **Reboot** button for the changes to take effect.

---

## 2.4.8 Configure the Sensor Configuration Parameters

The door sensor (pins 5 and 6) on the header can be used to monitor a door's open or closed state. There is an option on the **Sensor Configuration** page to trigger on an open or short condition on these pins. The door sensor alarm will be activated when the **Door Open Timeout** parameter has been met.

The intrusion sensor is an optical sensor installed on the Intercom board and will be activated when the Intercom is removed from the case.

Each sensor can trigger up to five different actions:

- Flash the LED until the sensor is deactivated (roughly 10 times/second)
- Activate the relay until the sensor is deactivated
- Loop an audio file out of the Intercom speaker until the sensor is deactivated
- Call an extension and establish two way audio
- Call an extension and play a pre-recorded audio file

**Note** Calling a preset extension can be set up as a point-to-point call, but currently can't send delayed DTMF tones.

1. Click **Sensor Config** to open the **Sensor Configuration** page (Figure 2-18).

Figure 2-18. Sensor Configuration Page

**CyberData Indoor Intercom**

**Sensor Configuration**

Home  
Device Config  
Networking  
SIP Config  
Nightringer  
**Sensor Config**  
Multicast Config  
Audio Config  
Event Config  
Autoprovisioning  
Update Firmware

**Door Sensor Settings**

Door Sensor Normally Closed:  Yes  No  
Door Open Timeout (in seconds):

Flash Button LED:   
Activate Relay:   
Play Audio Locally:

Make call to extension:   
Play recorded audio:   
Dial Out Extension:   
Dial Out ID:

**Intrusion Sensor Settings**



Flash Button LED:   
Activate Relay:   
Play Audio Locally:

Make call to extension:   
Play recorded audio:   
Dial Out Extension:   
Dial Out ID:

\* You need to reboot for changes to take effect

2. On the **Sensor Configuration** page, enter values for the parameters indicated in [Table 2-13](#).

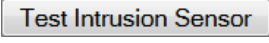
**Table 2-13. Sensor Configuration Parameters**

Web Page Item	Description
<b>Door Sensor Settings</b>	
Door Sensor Normally Closed	Select the inactive state of the door sensors.
Door Open Timeout (in seconds)	Select the number of seconds that you want to pass before the door sensor is activated.
Flash Button LED	Check this box to flash the LED until the sensor is deactivated (roughly 10 times/second).
Activate Relay	Check this box to activate the relay until the sensor is deactivated.
Play Audio Locally	Check this box to loop an audio file out of the Intercom speaker until the sensor is deactivated.
Make call to extension	Check this box to call a preset extension (once).
Play recorded audio	Check this box to play a pre-recorded audio file (once).
Dial Out Extension	Enter the desired dial-out extension number.
Dial Out ID	Type the desired Extension ID (64 character limit).
	Use this button to test the door sensor.
<b>Intrusion Sensor Settings</b>	
Flash Button LED	Check this box to flash the LED until the sensor is deactivated (roughly 10 times/second).
Activate Relay	Check this box to activate the relay until the sensor is deactivated.
Play Audio Locally	Check this box to loop an audio file out of the Intercom speaker until the sensor is deactivated.
Make call to extension	Check this box to call a preset extension (once).
Play recorded audio	Check this box to play a pre-recorded audio file (once).
Dial Out Extension	Enter the desired dial-out extension number.
Dial Out ID	Type the desired Extension ID (64 character limit).
	Use this button to test the Intrusion sensor.
	Click the <b>Save</b> button to save your configuration settings. <b>Note:</b> You need to reboot for changes to take effect.
	Click on the <b>Reboot</b> button to reboot the system.

**Note** You must click on the **Save** button and then the **Reboot** button for the changes to take effect.

## 2.4.9 Configure the Multicast Parameters

The Multicast Configuration page allows the device to join up to ten paging zones for receiving ulaw/alaw encoded RTP audio streams.

A paging zone can consist of one or many CyberData multicast group-enabled products. There is no limit to how many speakers can be in a given paging zone. Each multicast group is defined by a multicast address and port number.

Each multicast group is assigned a priority, allowing simultaneously arriving pages to be serviced based on importance. Multicast groups are compatible with IGMP through version 3. The device supports simultaneous SIP and Multicast.

1. Click on the **Multicast Configuration** button to open the **Multicast Configuration** page. See [Figure 2-19](#).

**Figure 2-19. Multicast Configuration Page**

**CyberData Indoor Intercom**

**Multicast Configuration**

Enable Multicast operation:



Priority	Address	Port	Name	Beep
9	239.168.3.10	11000	Emergency	<input type="checkbox"/>
8	239.168.3.9	10000	MG8	<input type="checkbox"/>
7	239.168.3.8	9000	MG7	<input type="checkbox"/>
6	239.168.3.7	8000	MG6	<input type="checkbox"/>
5	239.168.3.6	7000	MG5	<input type="checkbox"/>
SIP calls are considered priority 4.5				
4	239.168.3.5	6000	MG4	<input type="checkbox"/>
3	239.168.3.4	5000	MG3	<input type="checkbox"/>
2	239.168.3.3	4000	MG2	<input type="checkbox"/>
1	239.168.3.2	3000	MG1	<input type="checkbox"/>
0	239.168.3.1	2000	Background Music	<input type="checkbox"/>

Port range can be from 2000-65535  
 Ports must be even numbers  
 Priority 9 is the highest and 0 is the lowest  
 A higher priority audio stream will always supercede a lower one  
 Priority 9 streams will play at maximum volume

\* You need to reboot for changes to take effect

2. On the **Multicast Configuration** page, enter values for the parameters indicated in [Table 2-14](#).

**Table 2-14. Multicast Configuration Parameters**

Web Page Item	Description
Enable Multicast Operation	Enables or disables multicast operation.
<b>Device Settings</b>	
Priority	Indicates the priority for the multicast group. Priority <b>9</b> is the highest (emergency streams). <b>0</b> is the lowest (background music). SIP calls are considered priority <b>4.5</b> . See <a href="#">Section 2.4.9.1, "Assigning Priority"</a> for more details.
Address	Enter the multicast IP Address for this multicast group (15 character limit).
Port (range can be from 2000 to 65535)	Enter the port number for this multicast group (5 character limit).  <b>Note:</b> The multicast ports have to be even values. The webpage will enforce this restriction.
Multicast Group Name	Assign a descriptive name for this multicast group (25 character limit).
Beep	When selected, the device will play a beep before multicast audio is sent.
	Click the <b>Save</b> button to save your configuration settings. <b>Note:</b> You need to reboot for changes to take effect.
	Click on the <b>Reboot</b> button to reboot the system.

**Note** You must click on the **Save** button and then the **Reboot** button for the changes to take effect.

### 2.4.9.1 Assigning Priority

The device will prioritize simultaneous audio streams according to their priority in the list.

If both SIP and Multicast is enabled, SIP audio streams are considered priority **4.5**. SIP audio will interrupt multicast streams with priority **0** through **4** and will be interrupted by multicast streams with priority **5** through **9**.

During priority **9** multicast streams, the volume is set to maximum.

**Note** SIP calls, multicast streams, ring tones, ringback tones, and nightring tones are all prioritized.

Ringtones and Nightringtones

Ringtones all play at the same priority level. This means that it is possible to have a nightring tone and a normal ringtone playing at the same time.

## 2.4.10 Configure the Audio Configuration Parameters

The **Audio Configuration** page is used to add custom audio to the board. User uploaded audio will take precedence over the audio files shipped with the Intercom.

1. Click **Audio Config** to open the **Audio Configuration** page (Figure 2-20).

Figure 2-20. Audio Configuration Page





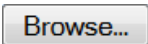



Figure 2-21. Audio Configuration Page (continued)

The screenshot displays a web-based audio configuration interface with a light blue background. It contains a vertical list of settings, each with a label, a status indicator, a file selection field, and a set of control buttons. The settings are as follows:

- 9:** Currently set to default. New File:  No file selected.
- Dot:** Currently set to default. New File:  No file selected.
- Audio test:** Currently set to default. New File:  No file selected.
- Page tone:** Currently set to pickup\_test12345\_8k2.wav. New File:  No file selected.
- Your IP Address is:** Currently set to default. New File:  No file selected.
- Rebooting:** Currently set to default. New File:  No file selected.
- Restoring Default:** Currently set to default. New File:  No file selected.
- Ringback tone:** Currently set to default. New File:  No file selected.
- Ring tone:** Currently set to default. New File:  No file selected.
- Intrusion Sensor Triggered:** Currently set to default. New File:  No file selected.
- Door Ajar:** Currently set to default. New File:  No file selected.
- Night Ring:** Currently set to default. New File:  No file selected.

2. On the **Audio Configuration** page, enter values for the parameters indicated in [Table 2-15](#).

**Table 2-15. Audio Configuration Parameters**

Web Page Item	Description
<b>Audio Files</b>	
0-9	The name of the audio configuration option is the same as the spoken audio that plays on the board (24 character limit). '0' corresponds to the spoken word "zero." '1' corresponds to the spoken word "one." '2' corresponds to the spoken word "two." '3' corresponds to the spoken word "three." '4' corresponds to the spoken word "four." '5' corresponds to the spoken word "five." '6' corresponds to the spoken word "six." '7' corresponds to the spoken word "seven." '8' corresponds to the spoken word "eight." '9' corresponds to the spoken word "nine."
Dot	Corresponds to the spoken word "dot." (24 character limit)
Audiotest	Corresponds to the message <b><i>"This is the CyberData IP speaker test message..."</i></b> (24 character limit)
Page tone	Corresponds to a simple tone used for beep on initialization and beep on page (24 character limit).
Your IP Address is	Corresponds to the message "Your IP address is..." (24 character limit).
Rebooting	Corresponds to the spoken word "Rebooting" (24 character limit).
Restoring default	Corresponds to the message "Restoring default" (24 character limit).
Ringback tone	This is the ringback tone that plays when calling a remote extension (24 character limit).
Ring tone	This is the tone that plays when set to ring when receiving a call (24 character limit).
Intrusion Sensor Triggered	Corresponds to the message "Intrusion Sensor Triggered" (24 character limit).
Door Ajar	Corresponds to the message "Door Ajar" (24 character limit).
Night Ring	Specifies the ringtone for nightring. By default this parameter uses the same audio file that is selected for the <b>Ring Tone</b> parameter.
	The <b>Browse</b> button will allow you to navigate to and select an audio file.
	The <b>Play</b> button will play that audio file.
	The <b>Delete</b> button will delete any user uploaded audio and restore the stock audio file.
	The <b>Save</b> button will download a new user audio file to the board once you've selected the file by using the <b>Browse</b> button. The <b>Save</b> button will delete any pre-existing user-uploaded audio files.

### 2.4.10.1 User-created Audio Files

User created audio files should be saved in the following format:

RIFF (little-endian) data, WAVE audio, Microsoft PCM, 16 bit, mono 8000 Hz

You can use the free utility *Audacity* to convert audio files into this format. See [Figure 2-22](#) through [Figure 2-24](#).

**Figure 2-22. Audacity 1**

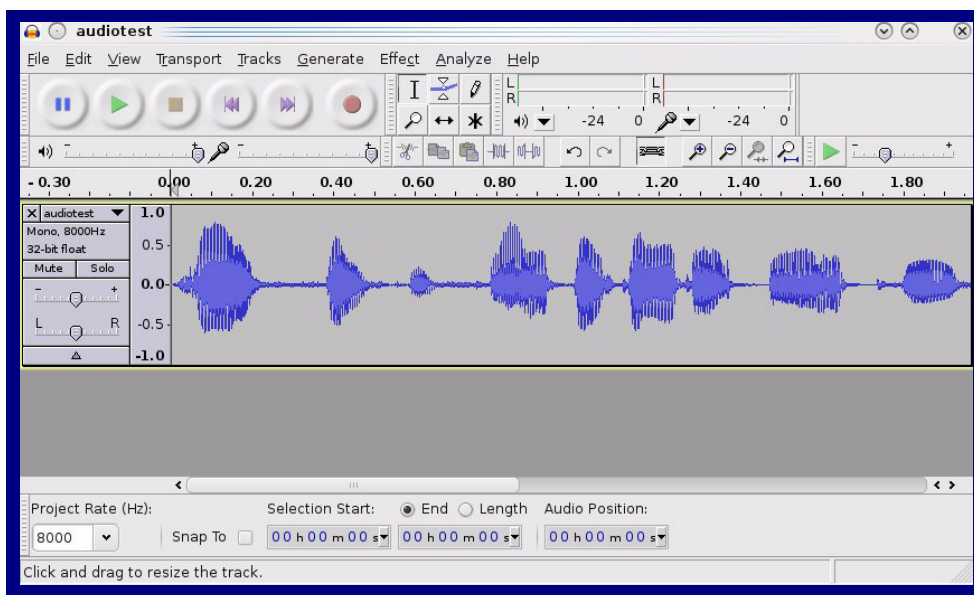

**Figure 2-23. Audacity 2**

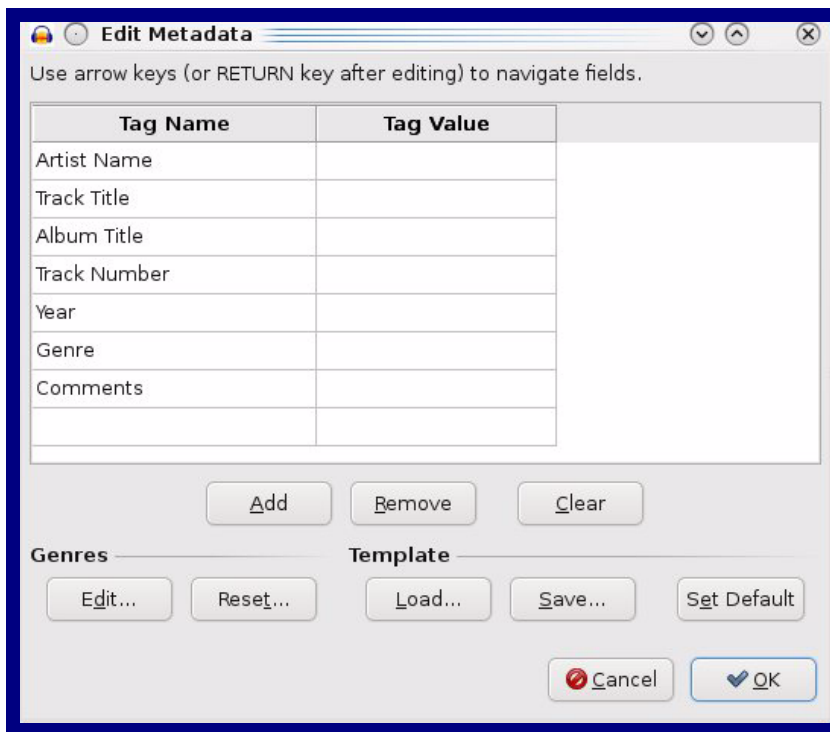

When you export an audio file with Audacity, save the output as:

- WAV (Microsoft) signed 16 bit PCM.

Figure 2-24. WAV (Microsoft) signed 16 bit PCM

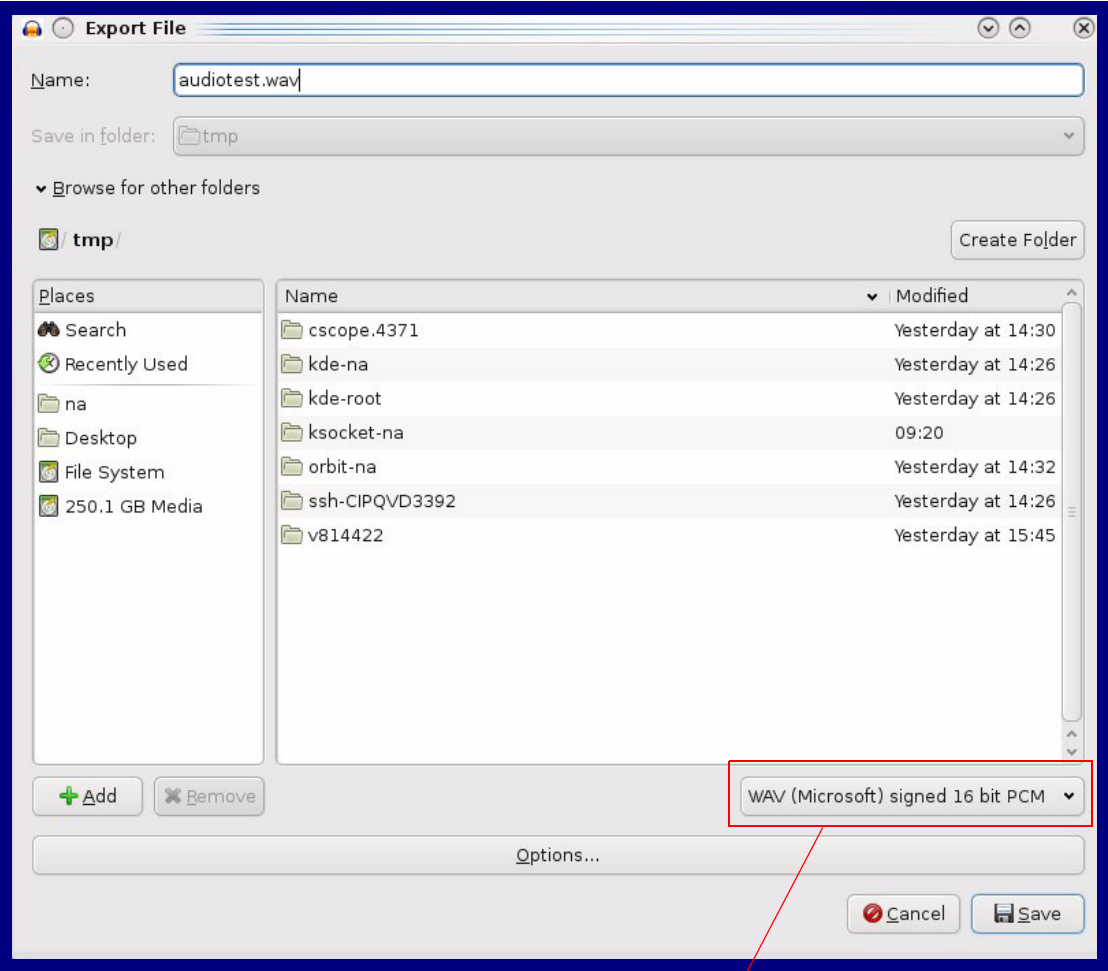

WAV (Microsoft) signed 16 bit PCM

## 2.4.11 Configure the Event Parameters

Click the **Event Config** button to open the **Event Configuration** page (Figure 2-25). The **Event Configuration** page specifies a remote server that can be used to receive HTTP POST events when actions take place on the board.

Figure 2-25. Event Configuration Page

**CyberData Indoor Intercom**

**Event Configuration**

Enable Event Generation:

Remote Event Server

Remote Event Server IP: 10.0.0.250

Remote Event Server Port: 8080

Remote Event Server URL: xmlparse\_engine

Events

Enable Button Events:

Enable Call Active Events:

Enable Call Terminated Events:

Enable Relay Activated Events:

Enable Relay Deactivated Events:

Enable Ring Events:

Enable Night Ring Events:

Enable Multicast Start Events:

Enable Multicast Stop Events:

Enable Power on Events:

Enable Sensor Events:

Enable Security Events:



Enable 60 second Heartbeat Events:

\* You need to reboot for changes to take effect

Save Test Event Reboot

Table 2-16 shows the web page items on the **Event Configuration** page.

**Table 2-16. Event Configuration**

<b>Web Page Item</b>	<b>Description</b>
Enable Event Generation	When selected, Event Generation is enabled.
<b>Remote Event Server</b>	
Remote Event Server IP	Type the Remote Event Server IP address. (64 character limit)
Remote Event Server Port	Type the Remote Event Server port number. (8 character limit)
Remote Event Server URL	Type the Remote Event Server URL. (127 character limit)
<b>Events</b>	
Enable Button Events	When selected, Button Events are enabled.
Enable Call Active Events	When selected, Call Active Events are enabled.
Enable Call Terminated Events	When selected, Call Terminated Events are enabled.
Enable Relay Activated Events	When selected, Relay Activated Events are enabled.
Enable Relay Deactivated Events	When selected, Relay Deactivated Events are enabled.
Enable Ring Events	When selected, Ring Events are enabled.
Enable Night Ring Events	When selected, there is a notification when the unit receives a night ring.
Enable Multicast Start Events	When selected, Multicast Start Events are enabled.
Enable Multicast Stop Events	When selected, Multicast Stop Events are enabled.
Enable Power On Events	When selected, Power On Events are enabled.
Enable Sensor Events	When selected, Sensor Events are enabled.
Enable Security Events	When selected, Security Events are enabled.
Enable 60 Second Heartbeat Events	When selected, 60 Second Heartbeat Events are enabled.
	Click the <b>Save</b> button to save your configuration settings. <b>Note:</b> You need to reboot for changes to take effect.
	Click on the <b>Test Event</b> button to test an event.
	Click on the <b>Reboot</b> button to reboot the system.

**Note** You must click on the **Save** button and then the **Reboot** button for the changes to take effect.

### 2.4.11.1 Example Packets for Events

The server and port are used to point to the listening server and the 'Remote Event Server URL' is the destination URL (typically the script running on the remote server that's used to parse and process the POST events).

**Note** The XML is URL-encoded before transmission so the following examples are not completely accurate.

Here are example packets for every event:

```
POST xmlparse_engine HTTP/1.1
Host: 10.0.3.79
User-Agent: CyberData/1.0.0
Content-Length: 197
Content-Type: application/x-www-form-urlencoded

<?xml version="1.0" encoding="ISO-8859-1"?>
<cyberdata NAME='CyberData VoIP Device' MAC='0020f70015b6'>
<event>POWERON</event>
</cyberdata>
```

```
POST xmlparse_engine HTTP/1.1
Host: 10.0.3.79
User-Agent: CyberData/1.0.0
Content-Length: 199
Content-Type: application/x-www-form-urlencoded

<?xml version="1.0" encoding="ISO-8859-1"?>
<cyberdata NAME='CyberData VoIP Device' MAC='0020f70015b6'>
<event>HEARTBEAT</event>
</cyberdata>
```

```
POST xmlparse_engine HTTP/1.1
Host: 10.0.3.79
User-Agent: CyberData/1.0.0
Content-Length: 196
Content-Type: application/x-www-form-urlencoded

<?xml version="1.0" encoding="ISO-8859-1"?>
<cyberdata NAME='CyberData VoIP Device' MAC='0020f70015b6'>
<event>BUTTON</event>
</cyberdata>
```

```
POST xmlparse_engine HTTP/1.1
Host: 10.0.3.79
User-Agent: CyberData/1.0.0
Content-Length: 201
Content-Type: application/x-www-form-urlencoded

<?xml version="1.0" encoding="ISO-8859-1"?>
<cyberdata NAME='CyberData VoIP Device' MAC='0020f70015b6'>
<event>CALL_ACTIVE</event>
</cyberdata>
POST xmlparse_engine HTTP/1.1
Host: 10.0.3.79
```

```
User-Agent: CyberData/1.0.0
Content-Length: 205
Content-Type: application/x-www-form-urlencoded

<?xml version="1.0" encoding="ISO-8859-1"?>
<cyberdata NAME='CyberData VoIP Device' MAC='0020f70015b6'>
<event>CALL_TERMINATED</event>
</cyberdata>

POST xmlparse_engine HTTP/1.1
Host: 10.0.3.79
User-Agent: CyberData/1.0.0
Content-Length: 197
Content-Type: application/x-www-form-urlencoded

<?xml version="1.0" encoding="ISO-8859-1"?>
<cyberdata NAME='CyberData VoIP Device' MAC='0020f70015b6'>
<event>RINGING</event>
</cyberdata>

POST xmlparse_engine HTTP/1.1
Host: 10.0.3.79
User-Agent: CyberData/1.0.0
Content-Length: 234
Content-Type: application/x-www-form-urlencoded

<?xml version="1.0" encoding="ISO-8859-1"?>
<cyberdata NAME='CyberData VoIP Device' MAC='0020f70015b6'>
<event>MULTICAST_START</event>
<index>8</index>
</cyberdata>

POST xmlparse_engine HTTP/1.1
Host: 10.0.3.79
User-Agent: CyberData/1.0.0
Content-Length: 233
Content-Type: application/x-www-form-urlencoded

<?xml version="1.0" encoding="ISO-8859-1"?>
<cyberdata NAME='CyberData VoIP Device' MAC='0020f70015b6'>
<event>MULTICAST_STOP</event>
<index>8</index>
</cyberdata>

POST xmlparse_engine HTTP/1.1
Host: 10.0.3.79
User-Agent: CyberData/1.0.0
Content-Length: 234
Content-Type: application/x-www-form-urlencoded
<?xml version="1.0" encoding="ISO-8859-1"?>
<cyberdata NAME='CyberData VoIP Device' MAC='0020f70015b6'>
<event>RELAY_ACTIVATED</event>
</cyberdata>
POST xmlparse_engine HTTP/1.1
Host: 10.0.3.79
```



```
User-Agent: CyberData/1.0.0
Content-Length: 234
Content-Type: application/x-www-form-urlencoded
<?xml version="1.0" encoding="ISO-8859-1"?>
<cyberdata NAME='CyberData VoIP Device' MAC='0020f70015b6'>
<event>RELAY_DEACTIVATED</event>
</cyberdata>
```

```
POST xmlparse_engine HTTP/1.1
Host: 10.0.3.79
User-Agent: CyberData/1.0.0
Content-Length: 234
Content-Type: application/x-www-form-urlencoded
<?xml version="1.0" encoding="ISO-8859-1"?>
<cyberdata NAME='CyberData VoIP Device' MAC='0020f70015b6'>
<event>NIGHTRINGING</event>
</cyberdata>
```

## 2.4.12 Configure the Autoprovisioning Parameters

Autoprovisioning can be used to configure your device automatically on boot, after a periodic delay, after sitting idle for a period of time, or at a specified time.

The autoprovisioning file contains the board configuration in xml format. Autoprovisioned values in this file will override values stored in on-board memory.

The autoprovisioning file can be hosted with a tftp or a web server and by default is named according to the MAC address of the device (for example: 0020f7350058.config). The autoprovisioning filename can also be specified.





The device does not have a real time clock but can sync with a network time server on boot.

1. Click the **Autoprovisioning** button to open the **Autoprovisioning Configuration** page. See [Figure 2-26](#).

**Figure 2-26. Autoprovisioning Configuration Page**

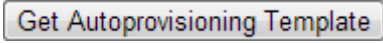
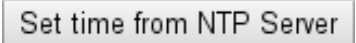
2. On the **Autoprovisioning Configuration** page, you may enter values for the parameters indicated in [Table 2-17](#).

**Table 2-17. Autoprovisioning Configuration Parameters**

Web Page Item	Description
<b>Autoprovisioning</b>	
Enable Autoprovisioning	See <a href="#">Section 2.4.12.1, "Autoprovisioning"</a> .
Get Autoprovisioning from DHCP	See <a href="#">Section 2.4.12.1, "Autoprovisioning"</a> .
Download Protocol	Allows you to select whether the autoprovisioning file is acquired via <b>TFTP</b> or <b>HTTP</b> .
Autoprovisioning Server (IP Address)	See <a href="#">Section 2.4.12.1, "Autoprovisioning"</a> (15 character limit).
Autoprovisioning Filename	Type the desired name for the autoprovisioning file.
Autoprovisioning Autoupdate (in minutes)	Type the desired time (in minutes) that you want the Autoprovisioning feature to update (6 character limit). <b>Note:</b> A value of <b>0</b> will disable this option.
Autoprovision at time (HHMMSS)	Type the desired time of day that you want the Autoprovisioning feature to update (must be 6 characters). <b>Note:</b> An empty value will disable this option.
Autoprovision when idle (in minutes > 10)	Type the desired time (in minutes greater than 10) that you want the Autoprovisioning feature to update after a certain amount of idle time (6 character limit). <b>Note:</b> A value of <b>0</b> will disable this option.
	Press the <b>Get Autoprovisioning Template</b> button to create an autoprovisioning file for this unit. See <a href="#">Section 2.4.12.2, "Get Autoprovisioning Template Button"</a>
<b>Clock</b>	
NTP Server	Allows you to select the NTP server (64 character limit).
Posix Timezone String	See <a href="#">Section 2.4.12.3, "Time Zone Strings"</a> (43 character limit).
Set Time with External NTP Server on boot	When selected, the time is set with an external NTP server when the device restarts.
Periodically update with time server	When selected, the time is periodically updated with a time server.
Time update period (in hours)	Allows you to select the time updated period (in hours) (4 character limit).
	Allows you to set the time from the NTP server.
<b>Current Time</b>	
Current Time in 24 hour format ( <b>HHMMSS</b> )	Allows you to input the current time in the 24 hour format. (6 character limit)
	Click on this button to set the clock after entering the current time.
	Click the <b>Save</b> button to save your configuration settings. <b>Note:</b> You need to reboot for changes to take effect.
	Click on the <b>Reboot</b> button to reboot the system.

3. After changing the parameters, click the **Save** button.

## 2.4.12.1 Autoprovisioning

**Autoprovisioning File** It is not necessary to set every option found in the autoprovisioning template. As long as the XML is valid, the file can contain any subset. Options not autoprovisioned will default to the values stored in the on board memory. For example if you only wanted to modify the device name, the following would be a valid autoprovisioning file:

```
<?xml version="1.0" encoding="utf-8" ?>
<specific>
  <MiscSettings>
    <DeviceName>auto Intercom</DeviceName>
  </MiscSettings>
</specific>
```

**Get Autoprovisioning from DHCP** When this option is checked, the device will automatically fetch its autoprovisioning server address from the DHCP server. The device will use the address specified in **OPTION 150** (TFTP-server-name) or **OPTION 66**. If both options are set, the device will use **OPTION 150**.

Refer to the documentation of your DHCP server for setting up **OPTION 150**.

To set up a Linux DHCPD server to serve autoprovisioning information (in this case using both option 66 and 150), here's an example dhcpd.conf:

```
# dhcpd.conf
#
# Configuration file for ISC dhcpd (see 'man dhcpd.conf')
#
ddns-update-style ad-hoc;

option option-150 code 150 = ip-address;

subnet 10.0.0.0 netmask 255.0.0.0 {
  max-lease-time 120;
  default-lease-time 120;

  option routers                10.0.0.1;
  option subnet-mask            255.0.0.0;

  option domain-name            "voiplab";
  option domain-name-servers    10.0.0.1;

  option time-offset             -8;      # Pacific Standard Time

  option tftp-server-name        "10.0.0.254";

  option option-150              10.0.0.254;

  range 10.10.0.1 10.10.2.1;}

```

**Autoprovisioning Server (IP Address)** Instead of using DHCP to provide the autoprovisioning tftp server address, you can specify an address manually.

**Autoprovisioning Autoupdate** When the device is set to autoprovision either after a period of time, or when idle, or at a time of day, the device will do the following:

- Re-download the autoprovisioning file.
- Compare this new file to the one downloaded on boot, and if it finds differences, force a system reset.

- After rebooting, the board will configure itself according to this new file.

Autoprovisioned Firmware Upgrades An Autoprovisioned firmware upgrade only happens after a reboot, will take roughly three minutes, and the web page will be unresponsive during this time.

The '**FirmwareVersion**' value in the xml file *must* match the version stored in the '**FirmwareFile**'.

```
<FirmwareVersion>v10.1.3</FirmwareVersion>  
<FirmwareFile>1013-intercom-uImage</FirmwareFile>
```

If these values are mismatched, the board can get stuck in a loop where it goes through the following sequence of actions:

1. The board downloads and writes a new firmware file.
2. After the next reboot, the board recognizes that the firmware version does not match.
3. The board downloads and writes the firmware file again.

CyberData has timed a firmware upgrade at 140 seconds. Therefore, if you suspect the board is stuck in a loop, either remove or comment out the **FirmwareVersion** line in the XML file and let the board boot as it normally does.

Autoprovisioned Audio Files Audio files are stored in non-volatile memory and an autoprovisioned audio file will only have to be downloaded once for each device. Loading many audio files to the device from the web page could cause it to appear unresponsive. If this happens, wait until the transfer is complete and then refresh the page.

The device uses the file name to determine when to download a new audio file. This means that if you used autoprovisioning to upload a file and then changed the contents of this file at the TFTP server, the device will not recognize that the file has changed (because the file name is the same).

Since audio files are stored in non-volatile memory, if autoprovisioning is disabled after they have been loaded to the board, the audio file settings will not change. You can force a change to the audio files on the board by clicking **Restore Default** on the **Audio Configuration** page or by changing the autoprovisioning file with "**default**" set as the file name.

## 2.4.12.2 Get Autoprovisioning Template Button

The **Get Autoprovisioning Template** button allows the user to generate, download, edit, and then store an autoprovisioning template on the server that serves the autoprovisioning files for devices.

To generate an autoprovisioning template directly from the device, complete the following steps:

1. On the **Autoprovisioning** page, click on the **Get Autoprovisioning Template** button.
2. You will see a window prompting you to save a configuration file (**.config**) to a location on your computer ([Figure 2-27](#)). The configuration file is the basis for the default configuration settings for your unit).
3. Choose a location to save the configuration file and click on **OK**. See [Figure 2-27](#).

**Figure 2-27. Configuration File**

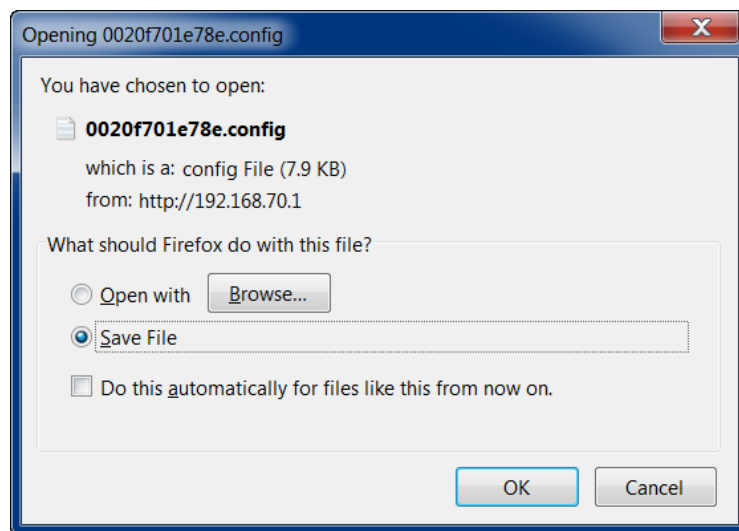

4. At this point, you can open and edit the autoprovisioning template to change the configuration settings in the template for the unit.
5. You can then upload the autoprovisioning file to a TFTP or HTTP server where the file can be loaded onto other devices.

### 2.4.12.3 Time Zone Strings

The posix time zone string tells the internal date and time utilities how to handle daylight savings time for different time zones. [Table 2-18](#) shows some common strings.

**Table 2-18. Common Time Zone Strings**

Time Zone	Time Zone String
US Pacific time	PST8PDT,M3.2.0/2:00:00,M11.1.0/2:00:00
US Mountain time	MST7MDT,M3.2.0/2:00:00,M11.1.0/2:00:00
US Eastern Time	EST5EDT,M3.2.0/2:00:00,M11.1.0/2:00:00
Phoenix Arizona <sup>a</sup>	MST7
US Central Time	CST6DST,M3.2.0/2:00:00,M11.1.0/2:00:00

a. Phoenix, Arizona does not use daylight savings time.

[Table 2-19](#) shows a breakdown of the parts that constitute the following time zone string:

- ***CST6DST,M3.2.0/2:00:00,M11.1.0/2:00:00***

**Table 2-19. Time Zone String Parts**

Time Zone String Part	Meaning
CST6CDT	The time zone offset from GMT and three character identifiers for the time zone.
CST	Central Standard Time
6	The (hour) offset from GMT/UTC
CDT	Central Daylight Time
M3.2.0/2:00:00	The date and time when daylight savings begins.
M3	The third month (March)
.2	The 2nd occurrence of the day (next item) in the month
.0	Sunday
/2:00:00	Time of day to change
M11.1.0/2:00:00	The date and time when daylight savings ends.
M11	The eleventh month (November)
.1	The 1st occurrence of the day (next item) in the month
.0	Sunday
/2:00:00	Time of day to change

Time Zone String Examples [Table 2-20](#) has some more examples of time zone strings.

**Table 2-20. Time Zone String Examples**

Time Zone	Time Zone String
Tokyo <sup>a</sup>	IST-9
Berlin <sup>b</sup>	CET-1MET,M3.5.0/1:00,M10.5.0/1:00

- a. Tokyo does not use daylight savings time.
- b. For Berlin, daylight savings time starts on the last Sunday in March at 01:00 UTC, and ends on the last Sunday in October at 01:00 UTC, and is one hour ahead of UTC.

Time Zone Identifier A user-definable three or four character time zone identifier (such as PST, EDT, IST, MUT, etc) is needed at the beginning of the posix time zone string to properly set the time. However, the specific letters or numbers used for the time zone identifier are not important and can be any three or four letter or number combination that is chosen by the user. However, the time zone identifier cannot be blank.

**Figure 2-28. Three or Four Character Time Zone Identifier**

You can also use the following URL when a certain time zone applies daylight savings time:

<http://www.timeanddate.com/time/dst/2011.html>

World GMT Table [Table 2-21](#) has information about the GMT time in various time zones.

**Table 2-21. World GMT Table**

Time Zone	City or Area Zone Crosses
GMT-12	Eniwetok
GMT-11	Samoa
GMT-10	Hawaii
GMT-9	Alaska
GMT-8	PST, Pacific US
GMT-7	MST, Mountain US
GMT-6	CST, Central US
GMT-5	EST, Eastern US
GMT-4	Atlantic, Canada
GMT-3	Brazilia, Buenos Aries
GMT-2	Mid-Atlantic
GMT-1	Cape Verdes
GMT	Greenwich Mean Time, Dublin
GMT+1	Berlin, Rome
GMT+2	Israel, Cairo
GMT+3	Moscow, Kuwait
GMT+4	Abu Dhabi, Muscat



**Table 2-21. World GMT Table (continued)**

<b>Time Zone</b>	<b>City or Area Zone Crosses</b>
GMT+5	Islamabad, Karachi
GMT+6	Almaty, Dhaka
GMT+7	Bangkok, Jakarta
GMT+8	Hong Kong, Beijing
GMT+9	Tokyo, Osaka
GMT+10	Sydney, Melbourne, Guam
GMT+11	Magadan, Soloman Is.
GMT+12	Fiji, Wellington, Auckland

---

## 2.5 Upgrade the Firmware and Reboot the Intercom



### Caution

**Equipment Hazard:** Devices with a serial number that begins with 2091xxxxx can only run firmware versions 10.0.0 or later.

---

### 2.5.1 Uploading the Firmware

To upload the firmware from your computer:

1. Retrieve the latest Intercom firmware file from the VoIP Indoor Intercom **Downloads** page at:  
<http://www.cyberdata.net/products/voip/digitalanalog/intercomindoorv3/downloads.html>
2. Unzip the firmware version file. This file may contain the following:
  - Firmware file
  - Release notes
3. Log in to the Intercom home page as instructed in [Section 2.4.3, "Log in to the Configuration Home Page"](#).
4. Click the **Update Firmware** button to open the **Upgrade Firmware** page. See [Figure 2-29](#).

Figure 2-29. Upgrade Firmware Page



5. Select **Browse**, and then navigate to the location of the Intercom firmware file.
6. Click **Submit**.

**Note** Do not reboot the board after pressing the **Submit** button.

**Note** This starts the upgrade process. Once the Intercom has uploaded the file, the **Uploading Firmware** countdown page appears, indicating that the firmware is being written to flash. The Intercom will automatically reboot when the upload is complete. When the countdown finishes, the **Upgrade Firmware** page will refresh. The uploaded firmware filename should be displayed in the system configuration (indicating successful upload and reboot).

Table 2-22 shows the web page items on the **Upgrade Firmware** page.

Table 2-22. Firmware Upgrade Parameters

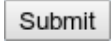
Web Page Item	Description
<b>File Upload</b>	
Firmware Version	Shows the current firmware version.
	Use the <b>Browse</b> button to navigate to the location of the Intercom firmware file that you want to upload.
	Click on the <b>Submit</b> button to automatically upload the selected firmware and reboot the system.

## 2.5.2 Reboot the Intercom

To reboot a Intercom, log in to the web page as instructed in [Section 2.4.3, "Log in to the Configuration Home Page"](#).

1. Click **Reboot** ([Figure 2-30](#)). A normal restart will occur.

**Figure 2-30. Reboot System Section**

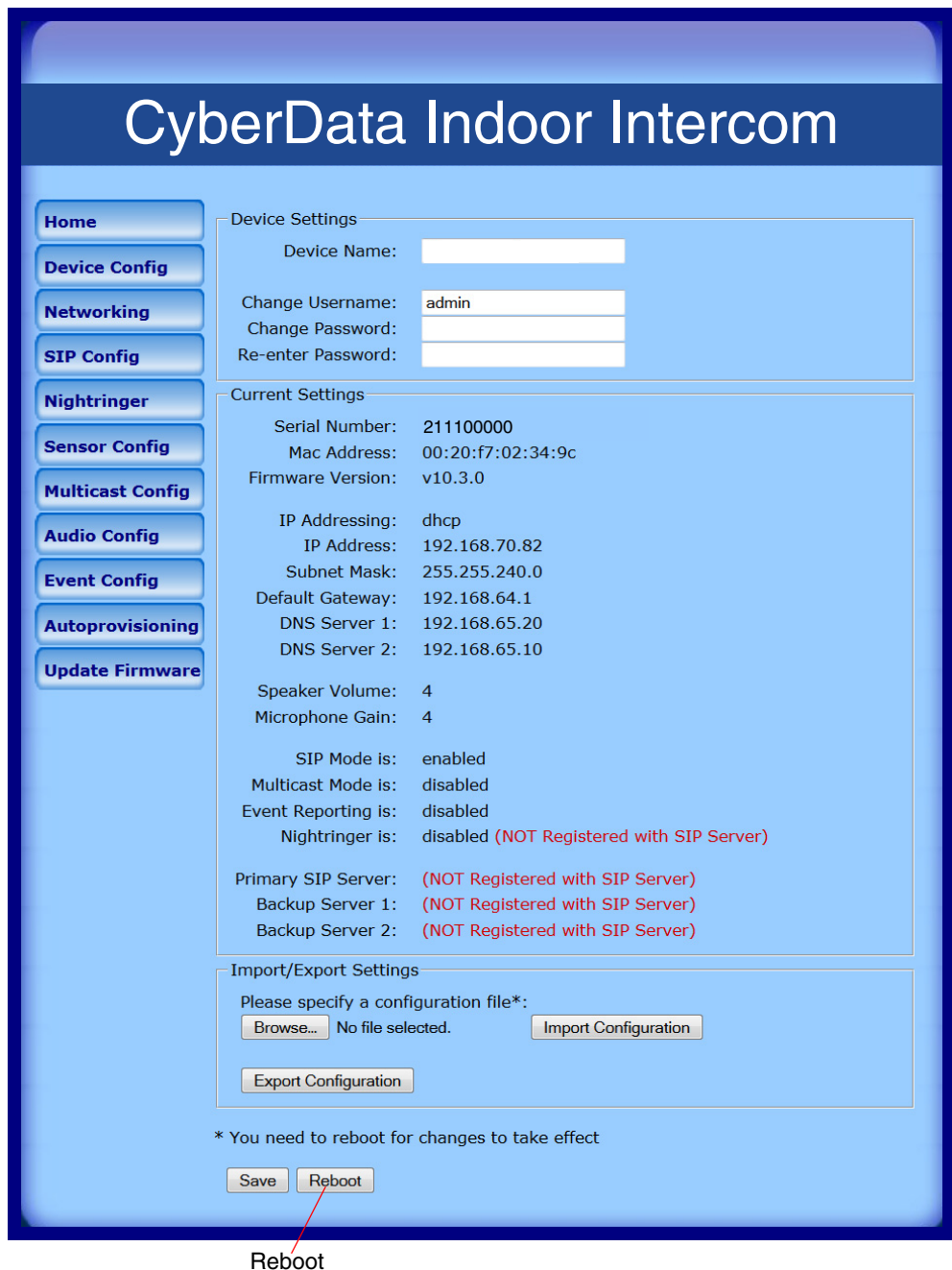

## 2.6 Command Interface

Some functions on the device can be activated using simple POST commands to the web interface. The examples in [Table 2-23](#) use the free unix utility, **wget** **commands**. However, any program that can send HTTP POST commands to the device should work.

### 2.6.1 Command Interface Post Commands

**Note** These commands require an authenticated session (a valid username and password to work).

**Table 2-23. Command Interface Post Commands**

Device Action	HTTP Post Command <sup>a</sup>
Trigger relay (for configured delay)	wget --user admin --password admin --auth-no-challenge --quiet -O /dev/null "http://10.0.3.71/cgi-bin/command.cgi" --post-data "test_relay=yes"
Place call to extension (example: extension 130)	wget --user admin --password admin --auth-no-challenge --quiet -O /dev/null "http://10.0.3.71/cgi-bin/command.cgi" --post-data "call=130"
Place point-to-point call <sup>b</sup> (example: IP phone address = 10.0.3.72)	wget --user admin --password admin --auth-no-challenge --quiet -O /dev/null "http://10.0.3.71/cgi-bin/command.cgi" --post-data "call=10.0.3.72"
Terminate active call	wget --user admin --password admin --auth-no-challenge --quiet -O /dev/null "http://10.0.3.71/cgi-bin/command.cgi" --post-data "terminate=yes"
Force reboot	wget --user admin --password admin --auth-no-challenge --quiet -O /dev/null "http://10.0.3.71/cgi-bin/command.cgi" --post-data "reboot=yes"
Test Audio button	wget --user admin --password admin --auth-no-challenge --quiet -O /dev/null "http://10.0.3.71/cgi-bin/command.cgi" --post-data "test_audio=yes"
Announce IP address	wget --user admin --password admin --auth-no-challenge --quiet -O /dev/null "http://10.0.3.71/cgi-bin/command.cgi" --post-data "speak_ip_address=yes"
Play the "0" audio file	wget --user admin --password admin --auth-no-challenge --quiet -O /dev/null "http://10.0.3.71/cgi-bin/audioconfig.cgi" --post-data "play_0=yes"
Play the "1" audio file	wget --user admin --password admin --auth-no-challenge --quiet -O /dev/null "http://10.0.3.71/cgi-bin/audioconfig.cgi" --post-data "play_1=yes"
Play the "2" audio file	wget --user admin --password admin --auth-no-challenge --quiet -O /dev/null "http://10.0.3.71/cgi-bin/audioconfig.cgi" --post-data "play_2=yes"
Play the "3" audio file	wget --user admin --password admin --auth-no-challenge --quiet -O /dev/null "http://10.0.3.71/cgi-bin/audioconfig.cgi" --post-data "play_3=yes"

**Table 2-23. Command Interface Post Commands (continued)**

<b>Device Action</b>	<b>HTTP Post Command<sup>a</sup></b>
Play the "4" audio file	wget --user admin --password admin --auth-no-challenge --quiet -O /dev/null "http://10.0.3.71/cgi-bin/audioconfig.cgi" --post-data "play_4=yes"
Play the "5" audio file	wget --user admin --password admin --auth-no-challenge --quiet -O /dev/null "http://10.0.3.71/cgi-bin/audioconfig.cgi" --post-data "play_5=yes"
Play the "6" audio file	wget --user admin --password admin --auth-no-challenge --quiet -O /dev/null "http://10.0.3.71/cgi-bin/audioconfig.cgi" --post-data "play_6=yes"
Play the "7" audio file	wget --user admin --password admin --auth-no-challenge --quiet -O /dev/null "http://10.0.3.71/cgi-bin/audioconfig.cgi" --post-data "play_7=yes"
Play the "8" audio file	wget --user admin --password admin --auth-no-challenge --quiet -O /dev/null "http://10.0.3.71/cgi-bin/audioconfig.cgi" --post-data "play_8=yes"
Play the "9" audio file	wget --user admin --password admin --auth-no-challenge --quiet -O /dev/null "http://10.0.3.71/cgi-bin/audioconfig.cgi" --post-data "play_9=yes"
Play the "Dot" audio file	wget --user admin --password admin --auth-no-challenge --quiet -O /dev/null "http://10.0.3.71/cgi-bin/audioconfig.cgi" --post-data "play_d=yes"
Play the "Audio Test" audio file (from Audio Config)	wget --user admin --password admin --auth-no-challenge --quiet -O /dev/null "http://10.0.3.71/cgi-bin/audioconfig.cgi" --post-data "play_audiotest=yes"
Play the "Page Tone" audio file	wget --user admin --password admin --auth-no-challenge --quiet -O /dev/null "http://10.0.3.71/cgi-bin/audioconfig.cgi" --post-data "play_pagetone=yes"
Play the "Your IP Address Is" audio file	wget --user admin --password admin --auth-no-challenge --quiet -O /dev/null "http://10.0.3.71/cgi-bin/audioconfig.cgi" --post-data "play_youripaddressis=yes"
Play the "Rebooting" audio file	wget --user admin --password admin --auth-no-challenge --quiet -O /dev/null "http://10.0.3.71/cgi-bin/audioconfig.cgi" --post-data "play_rebooting=yes"
Play the "Restoring Default" audio file	wget --user admin --password admin --auth-no-challenge --quiet -O /dev/null "http://10.0.3.71/cgi-bin/audioconfig.cgi" --post-data "play_restoringdefault=yes"
Play the "Ringback tone" audio file	wget --user admin --password admin --auth-no-challenge --quiet -O /dev/null "http://10.0.3.71/cgi-bin/audioconfig.cgi" --post-data "play_ringback=yes"
Play the "Ring tone" audio file	wget --user admin --password admin --auth-no-challenge --quiet -O /dev/null "http://10.0.3.71/cgi-bin/audioconfig.cgi" --post-data "play_ringtone=yes"
Play the "Intrusion Sensor Triggered" audio file	wget --user admin --password admin --auth-no-challenge --quiet -O /dev/null "http://10.0.3.71/cgi-bin/audioconfig.cgi" --post-data "play_intrusionsensortriggered=yes"
Play the "Door Ajar" audio file	wget --user admin --password admin --auth-no-challenge --quiet -O /dev/null "http://10.0.3.71/cgi-bin/audioconfig.cgi" --post-data "play_doorajar=yes"

**Table 2-23. Command Interface Post Commands (continued)**

<b>Device Action</b>	<b>HTTP Post Command<sup>a</sup></b>
Play the "Night Ring" audio file	wget --user admin --password admin --auth-no-challenge --quiet -O /dev/null "http://10.0.3.71/cgi-bin/audioconfig.cgi" --post-data "play_nightring=yes"
Delete the "0" audio file	wget --user admin --password admin --auth-no-challenge --quiet -O /dev/null "http://10.0.3.71/cgi-bin/audioconfig.cgi" --post-data "delete_0=yes"
Delete the "1" audio file	wget --user admin --password admin --auth-no-challenge --quiet -O /dev/null "http://10.0.3.71/cgi-bin/audioconfig.cgi" --post-data "delete_1=yes"
Delete the "2" audio file	wget --user admin --password admin --auth-no-challenge --quiet -O /dev/null "http://10.0.3.71/cgi-bin/audioconfig.cgi" --post-data "delete_2=yes"
Delete the "3" audio file	wget --user admin --password admin --auth-no-challenge --quiet -O /dev/null "http://10.0.3.71/cgi-bin/audioconfig.cgi" --post-data "delete_3=yes"
Delete the "4" audio file	wget --user admin --password admin --auth-no-challenge --quiet -O /dev/null "http://10.0.3.71/cgi-bin/audioconfig.cgi" --post-data "delete_4=yes"
Delete the "5" audio file	wget --user admin --password admin --auth-no-challenge --quiet -O /dev/null "http://10.0.3.71/cgi-bin/audioconfig.cgi" --post-data "delete_5=yes"
Delete the "6" audio file	wget --user admin --password admin --auth-no-challenge --quiet -O /dev/null "http://10.0.3.71/cgi-bin/audioconfig.cgi" --post-data "delete_6=yes"
Delete the "7" audio file	wget --user admin --password admin --auth-no-challenge --quiet -O /dev/null "http://10.0.3.71/cgi-bin/audioconfig.cgi" --post-data "delete_7=yes"
Delete the "8" audio file	wget --user admin --password admin --auth-no-challenge --quiet -O /dev/null "http://10.0.3.71/cgi-bin/audioconfig.cgi" --post-data "delete_8=yes"
Delete the "9" audio file	wget --user admin --password admin --auth-no-challenge --quiet -O /dev/null "http://10.0.3.71/cgi-bin/audioconfig.cgi" --post-data "delete_9=yes"
Delete the "Audio Test" audio file	wget --user admin --password admin --auth-no-challenge --quiet -O /dev/null "http://10.0.3.71/cgi-bin/audioconfig.cgi" --post-data "delete_audiotest=yes"
Delete the "Page Tone" audio file	wget --user admin --password admin --auth-no-challenge --quiet -O /dev/null "http://10.0.3.71/cgi-bin/audioconfig.cgi" --post-data "delete_pagetone=yes"
Delete the "Your IP Address Is" audio file	wget --user admin --password admin --auth-no-challenge --quiet -O /dev/null "http://10.0.3.71/cgi-bin/audioconfig.cgi" --post-data "delete_youripaddressis=yes"
Delete the "Rebooting" audio file	wget --user admin --password admin --auth-no-challenge --quiet -O /dev/null "http://10.0.3.71/cgi-bin/audioconfig.cgi" --post-data "delete_rebooting=yes"
Delete the "Restoring Default" audio file	wget --user admin --password admin --auth-no-challenge --quiet -O /dev/null "http://10.0.3.71/cgi-bin/audioconfig.cgi" --post-data "delete_restoringdefault=yes"

**Table 2-23. Command Interface Post Commands (continued)**

<b>Device Action</b>	<b>HTTP Post Command<sup>a</sup></b>
Delete the "Ringback tone" audio file	wget --user admin --password admin --auth-no-challenge --quiet -O /dev/null "http://10.0.3.71/cgi-bin/audioconfig.cgi" --post-data "delete_ringback=yes"
Delete the "Ring tone" audio file	wget --user admin --password admin --auth-no-challenge --quiet -O /dev/null "http://10.0.3.71/cgi-bin/audioconfig.cgi" --post-data "delete_ringtone=yes"
Delete the "Intrusion Sensor Triggered" audio file	wget --user admin --password admin --auth-no-challenge --quiet -O /dev/null "http://10.0.3.71/cgi-bin/audioconfig.cgi" --post-data "delete_intrusionsensortriggered=yes"
Delete the "Door Ajar" audio file	wget --user admin --password admin --auth-no-challenge --quiet -O /dev/null "http://10.0.3.71/cgi-bin/audioconfig.cgi" --post-data "delete_doorajar=yes"
Delete the "Night Ring" audio file	wget --user admin --password admin --auth-no-challenge --quiet -O /dev/null "http://10.0.3.71/cgi-bin/audioconfig.cgi" --post-data "delete_nightring=yes"
Trigger the Door Sensor Test (Sensor Config page)	wget --user admin --password admin --auth-no-challenge --quiet -O /dev/null "http://10.0.3.71/cgi-bin/sensorconfig.cgi" --post-data "doortest=yes"
Trigger the Intrusion Sensor Test (Sensor Config page)	wget --user admin --password admin --auth-no-challenge --quiet -O /dev/null "http://10.0.3.71/cgi-bin/sensorconfig.cgi" --post-data "intrusiontest=yes"

a. Type and enter all of each http POST command on one line.

b. Must be in point-to-point mode see [Section 2.4.6.2, "Point-to-Point Configuration"](#)



# Appendix A: Mounting the Indoor Intercom

## A.1 Wall Mounting Components

Before you mount the Intercom, make sure that you have received all the parts for each Intercom. Refer to the following tables.

**Table A-1. Wall Mounting Components (Part of the Accessory Kit)**

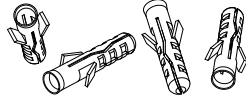
Quantity	Part Name	Illustration
4	Sheet Metal Screw	
4	Plastic Ribbed Anchor	

**Table A-2. Gang Box Mounting Components**

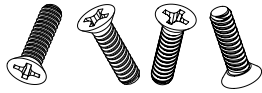
Quantity	Part Name	Illustration
4	#6-32 FlatHead Countersunk Machine Screw	

## A.2 Cable Connections

Figure A-1 shows how to properly connect the VoIP Intercom.

Figure A-1. Cable Connections

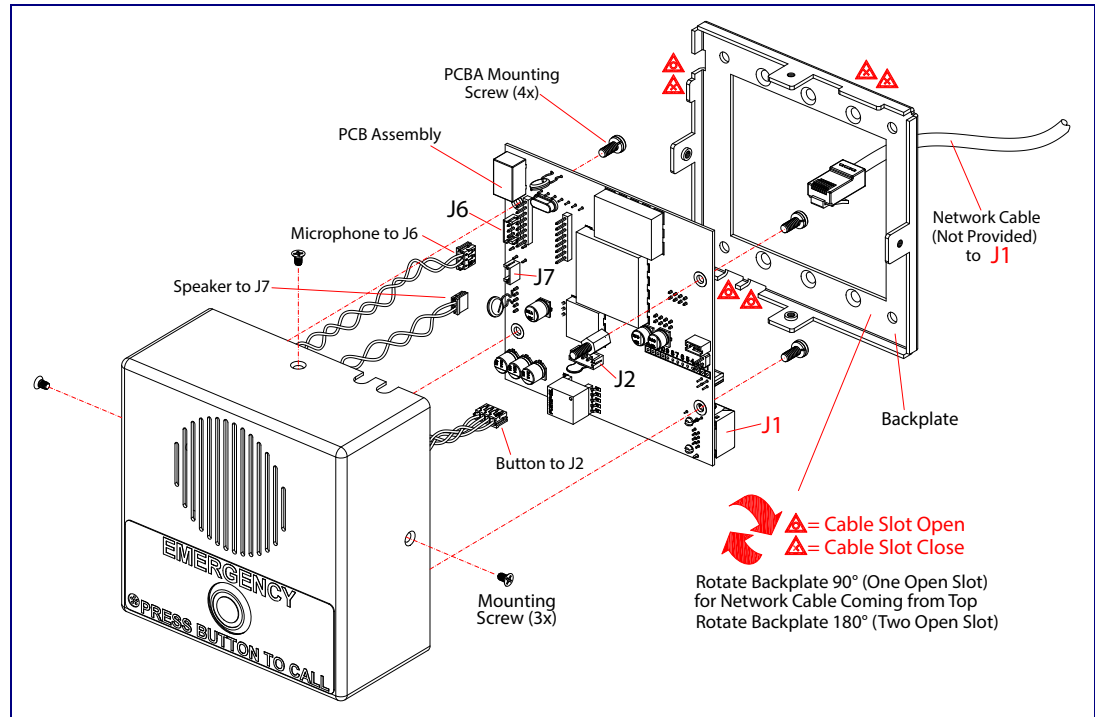

## A.3 Wall Mounting Option

Figure A-2 shows a wall mounting option.

**Note** Be sure to connect the VoIP Indoor Intercom to the Earth Ground.

**Figure A-2. Wall Mounting Option**

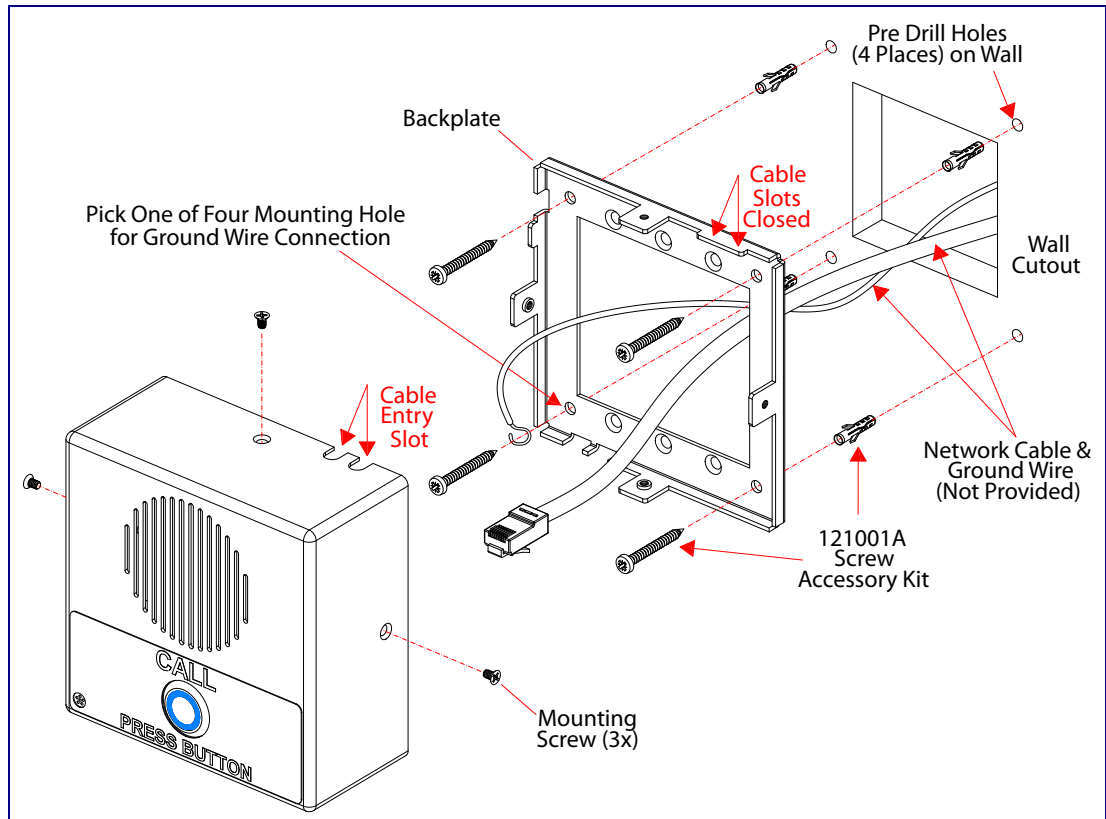

## A.4 Gang Box Option

Figure A-3 shows a 1-Gang Box and a 2-Gang Box mounting option.

**Note** Be sure to connect the VoIP Indoor Intercom to the Earth Ground.

**Figure A-3. Gang Box Mounting**

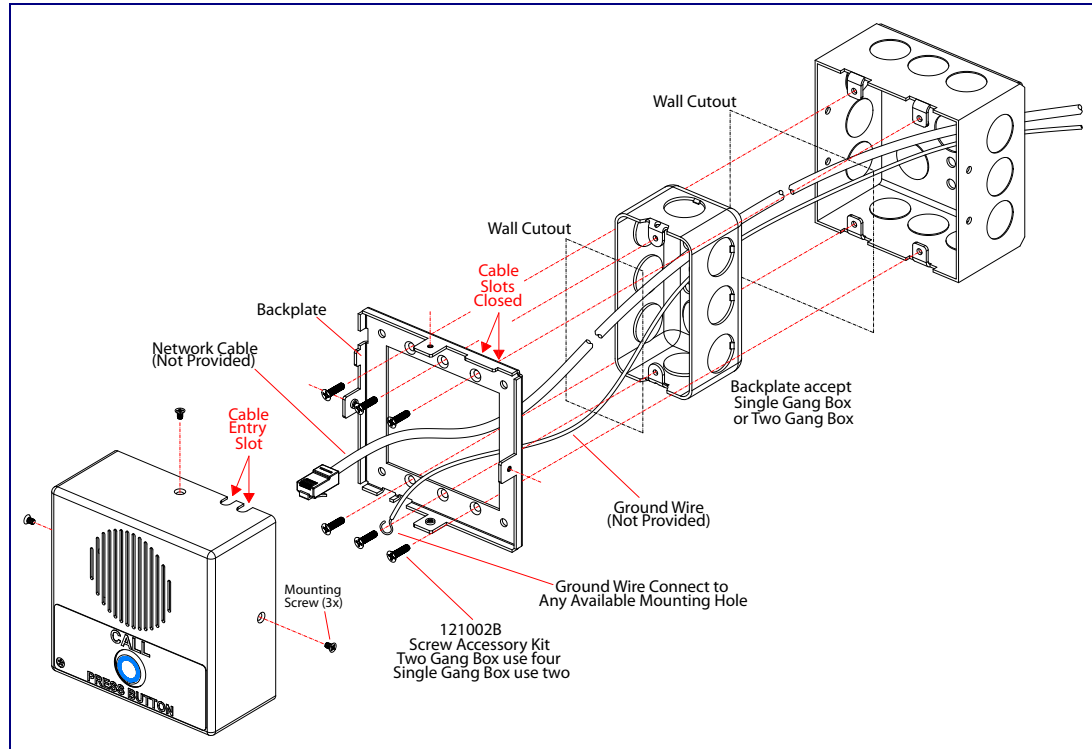

## A.5 Wall Cutout Dimensions

Figure A-4 shows the maximum recommended wall cutout dimensions.

**Figure A-4. Maximum Recommended Wall Cutout Dimensions**

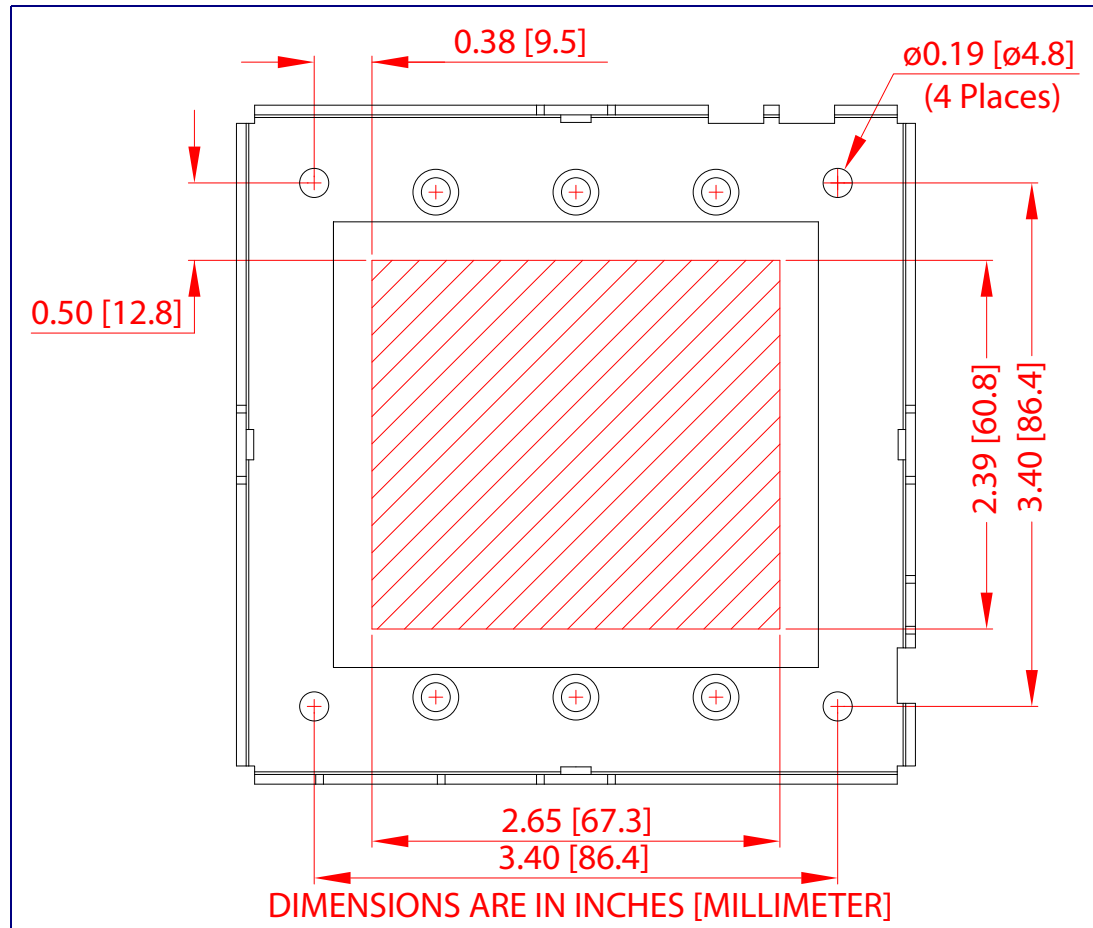

## A.6 PCB Dimensions

Figure A-5 shows the PCB dimensions and the intrusion sensor range.

**Figure A-5. PCB Dimensions and Intrusion Sensor Range**

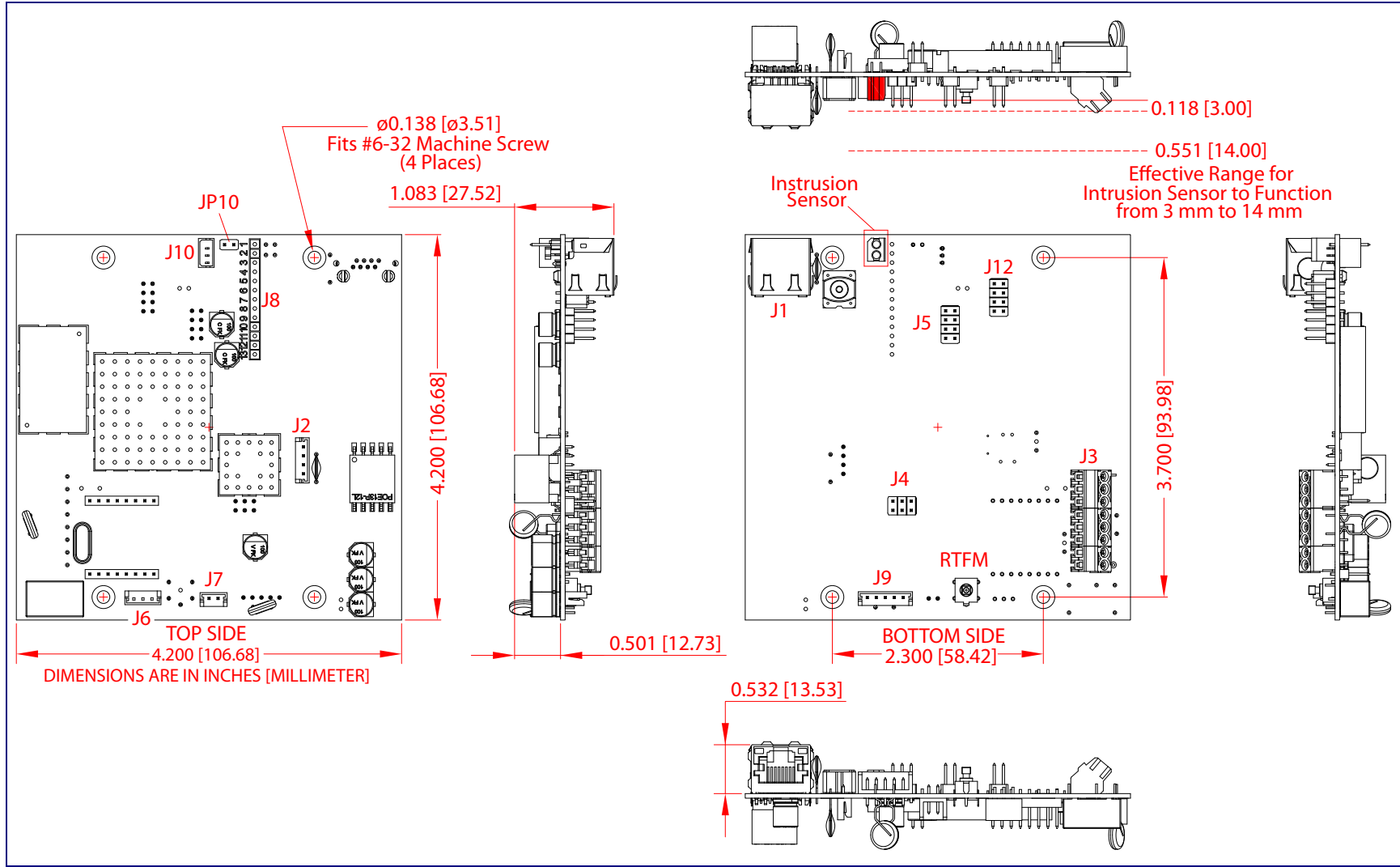

# Appendix B: Setting up a TFTP Server

---

## B.1 Set up a TFTP Server

Autoprovisioning requires a TFTP server for hosting the configuration file.

---

### B.1.1 In a LINUX Environment

To set up a TFTP server on LINUX:

1. Create a directory dedicated to the TFTP server, and move the files to be uploaded to that directory.
2. Run the following command where `/tftpboot/` is the path to the directory you created in [Step 1](#): the directory that contains the files to be uploaded. For example:

```
in.tftpd -l -s /tftpboot/your_directory_name
```

---

### B.1.2 In a Windows Environment

You can find several options online for setting up a Windows TFTP server. This example explains how to use the Solarwinds freeware TFTP server, which you can download from the following website address:

<http://www.cyberdata.net/support/voip/solarwinds.html>

To set up a TFTP server on Windows:

1. Install and start the software.
2. Select **File/Configure/Security** tab/**Transmit Only**.
3. Make a note of the default directory name, and then move the firmware files to be uploaded to that directory.

# Appendix C: Troubleshooting/Technical Support

---

## C.1 Frequently Asked Questions (FAQ)

A list of frequently asked questions (FAQs) are available on the VoIP Indoor Intercom product page at:

<http://www.cyberdata.net/products/voip/digitalanalog/intercomindoorv3/faqs.html>

Select the support page for your product to see a list of frequently asked questions for the CyberData product:

---

## C.2 Documentation

The documentation for this product is released in an English language version only. You can download PDF copies of CyberData product documentation from the VoIP Indoor Intercom product page at:

<http://www.cyberdata.net/products/voip/digitalanalog/intercomindoorv3/docs.html>



---

## C.3 Contact Information

Contact	<p>CyberData Corporation 3 Justin Court Monterey, CA 93940 USA <a href="http://www.CyberData.net">www.CyberData.net</a> Phone: 800-CYBERDATA (800-292-3732) Fax: 831-373-4193</p>
Sales	<p>Sales 831-373-2601 Extension 334</p>
Technical Support	<p>The fastest way to get technical support for your VoIP product is to submit a VoIP Technical Support form at the following website:</p> <p><a href="http://www.cyberdata.net/support/contactsupportvoip.php">http://www.cyberdata.net/support/contactsupportvoip.php</a></p> <p>The Support Form initiates a ticket which CyberData uses for tracking customer requests. Most importantly, the Support Form tells us which PBX system and software version that you are using, the make and model of the switch, and other important information. This information is essential for troubleshooting. Please also include as much detail as possible in the <b>Comments</b> section of the Support Form.</p> <p>Phone: (831) 373-2601, Ext. 333 Email: <a href="mailto:support@cyberdata.net">support@cyberdata.net</a></p>
Returned Materials Authorization	<p>To return the product, contact the Returned Materials Authorization (RMA) department:</p> <p>Phone: 831-373-2601, Extension 136 Email: <a href="mailto:RMA@CyberData.net">RMA@CyberData.net</a></p> <p>When returning a product to CyberData, an approved CyberData RMA number must be printed on the outside of the original shipping package. Also, RMA numbers require an active VoIP Technical Support ticket number. A product will not be accepted for return without an approved RMA number. Send the product, in its original package, to the following address:</p> <p>CyberData Corporation 3 Justin Court Monterey, CA 93940 Attention: RMA "your RMA number"</p>
RMA Status Form	<p>If you need to inquire about the repair status of your product(s), please use the CyberData RMA Status form at the following web address:</p> <p><a href="http://www.cyberdata.net/support/rmastatus.html">http://www.cyberdata.net/support/rmastatus.html</a></p>

---

## C.4 Warranty

CyberData warrants its product against defects in material or workmanship for a period of two years from the date of purchase. Should the product fail Within Warranty, CyberData will repair or replace the product free of charge. This warranty includes all parts and labor.

Should the product fail Out of the Warranty period, a flat rate repair charge of one half of the purchase price of the product will be assessed. Repairs that are Within Warranty period but are damaged by improper installation, modification, or abuse are deemed Out of Warranty and will be charged at the Out of Warranty rate. A device is deemed Out of Warranty when its purchase date is longer than two years or when the device has been damaged due to human error during installation, modification, or abuse. A replacement unit will be offered at full cost if the device cannot be repaired.

**End of Life Devices out of warranty** are included under this policy. However, End of Life devices are not eligible for our Spare in the Air program. End of Life devices are devices that are no longer produced or sold. Therefore, we cannot offer a Spare in the Air replacement. Technical support is still available for these devices. However, no firmware revisions or updates will be scheduled. If an End of Life device cannot be repaired, a replacement of a current version of the device may be offered at MSRP.

Products shipped to CyberData, both within and out of warranty, are shipped at the expense of the customer. CyberData will pay return shipping charges for repaired products.

CyberData shall not under any circumstances be liable to any person for any special, incidental, indirect or consequential damages, including without limitation, damages resulting from use or malfunction of the products, loss of profits or revenues or costs of replacement goods, even if CyberData is informed in advance of the possibility of such damages.

---

### C.4.1 Warranty & RMA Returns within the United States

If service is required, you must contact CyberData Technical Support prior to returning any products to CyberData. Our Technical Support staff will determine if your product should be returned to us for further inspection. If Technical Support determines that your product needs to be returned to CyberData, an RMA number will be issued to you at this point.

Your issued RMA number must be printed on the outside of the shipping box. No product will be accepted for return without an approved RMA number. The product in its original package should be sent to the following address:

CyberData Corporation

3 Justin Court.

Monterey, CA 93940

Attn: RMA "xxxxxx"

---

## C.4.2 Warranty & RMA Returns outside of the United States

If you purchased your equipment through an authorized international distributor or reseller, please contact them directly for product repairs.

---

## C.4.3 Spare in the Air Policy

CyberData now offers a *Spare in the Air* no wait policy for warranty returns within the United States and Canada. More information about the *Spare in the Air* policy is available at the following web address:

<http://www.cyberdata.net/support/warranty/spareintheair.html>

---

## C.4.4 Return and Restocking Policy

For our authorized distributors and resellers, please refer to your CyberData Service Agreement for information on our return guidelines and procedures.

For End Users, please contact the company that you purchased your equipment from for their return policy.

---

## C.4.5 Warranty and RMA Returns Page

The most recent warranty and RMA information is available at the CyberData Warranty and RMA Returns Page at the following web address:

<http://www.cyberdata.net/support/warranty/index.html>

# Index

---

## Numerics

16 AWG gauge wire 9

## A

act light 15  
 activate relay (door sensor) 38  
 activate relay (intrusion sensor) 38  
 address, configuration login 20  
 announcing a device's IP address 16  
 audio configuration 41  
   night ring tone parameter 43  
 audio configuration page 41  
 audio encodings 4  
 audio files, user-created 44  
 autoprovision at time (HHMMSS) 52  
 autoprovision when idle (in minutes > 10) 52  
 autoprovisioning 52, 53  
   autoprovisioned audio files 54  
   autoprovisioned firmware upgrades 54  
   autoprovisioning autoupdate 53  
   autoprovisioning from DHCP 53  
   autoprovisioning server (IP address) 53  
   get autoprovisioning template button 52  
   setting up a TFTP server 72  
 autoprovisioning autoupdate (in minutes) 52  
 autoprovisioning configuration 51, 52  
 autoprovisioning filename 52  
 autoprovisioning server (IP Address) 52  
 auxiliary relay 5

## B

backup SIP server 1 30  
 backup SIP server 2 30  
 backup SIP servers, SIP server  
   backups 30  
 baud rate  
   verifying 15  
 boost (volume) 24

## C

cable connections 67  
 call button 8

LED 8  
 call button LED 8  
 changing  
   the web access password 23  
 Cisco SRST 30  
 command interface 62  
 commands 62  
 configurable parameters 24, 28, 30  
 configuration  
   audio 41  
   default IP settings 18  
   door sensor 36  
   intrusion sensor 36  
   network 27  
   SIP 29  
   using Web interface 18  
 configuration home page 20  
 configuration page  
   configurable parameters 24, 28  
 contact information 74  
 contact information for CyberData 74  
 cutout dimensions 70  
 cutout dimensions, maximum recommended 70  
 CyberData contact information 74

## D

default  
   gateway 18  
   intercom settings 77  
   IP address 18  
   subnet mask 18  
   username and password 18  
   web login username and password 20  
 default gateway 18, 28  
 default intercom settings 17  
 default IP settings 18  
 default login address 20  
 device configuration 23  
   device configuration parameters 52  
   the device configuration page 51  
 device configuration page 23  
 device configuration parameters 24  
 device configuration password  
   changing for web configuration access 23  
 DHCP Client 4  
 DHCP IP addressing 28  
 dial out extension (door sensor) 38  
 dial out extension (intrusion sensor) 38  
 dial out extension strings 31

- dial-out extension strings 33
- dimensions 5
  - maximum recommended wall cutout dimensions 70
  - pcb dimensions and intrusion sensor range 71
- discovery utility program 20
- DNS server 28
- door sensor 36, 38, 43
  - activate relay 38
  - dial out extension 38
  - door open timeout 38
  - door sensor normally closed 38
  - flash button LED 38
  - play audio locally 38
- door strike intermediate relay 12
- download protocol, HTTP or TFTP 52
- DTFM
  - play tone during DTMF activation 24
- DTMF tones 31, 33
- DTMF tones (using rfc2833) 31

## E

- earth ground 68, 69
- enable night ring events 47
- event configuration
  - enable night ring events 47
- expiration time for SIP server lease 30, 35
- export configuration button 22
- export settings 22

## F

- factory default settings 17
  - how to set 17
- firmware
  - where to get the latest firmware 59
- flash button LED (door sensor) 38
- flash button LED (intrusion sensor) 38

## G

- gang box option 69
- get autoprovisioning from DHCP 52
- get autoprovisioning template 52
- get autoprovisioning template button 52
- GMT table 57
- GMT time 57
- green link light 15

## H

- home page 20
- http POST command 62
- http web-based configuration 4

## I

- identifier names (PST, EDT, IST, MUT) 57
- identifying your product 1
- illustration of intercom mounting process 66
- import configuration button 22
- import settings 22
- import/export settings 22
- installation, typical intercom system 2
- intercom configuration
  - default IP settings 18
- intercom configuration page
  - configurable parameters 30
- intrusion sensor 36, 38
  - activate relay 38
  - dial out extension 38
  - flash button LED 38
  - play audio locally 38
- IP address 18, 28
- IP addressing 28
  - default
    - IP addressing setting 18

## J

- J3 terminal block, 16 AWG gauge wire 9

## L

- lease, SIP server expiration time 30, 35
- lengthy pages 40
- link light 15
- Linux, setting up a TFTP server on 72
- local SIP port 30
- log in address 20

## M

- MGROUP
  - MGROUP Name 40
- mounting
  - gang box mounting 69

- gang box option 69
- maximum recommended wall cutout dimensions 70
- wall cutout dimensions 70, 71
- wall mounting 68
- wall mounting components 66
- wall mounting option 68
- mounting an intercom 66
- multicast configuration 39
- Multicast IP Address 40

## N

- navigation (web page) 19
- navigation table 19
- network configuration of intercom 27
- network rate 5
- Network Setup 27
- nightring tones 40
- Nightringer 9, 34, 55
- Nightringer in peer to peer mode (cannot be used) 34
- nightringer settings 35
- Nightringer, SIP registration required 34
- NTP server 52

## O

- on-board relay 10
- operating temperature 5

## P

- packet time 4
- pages (lengthy) 40
- part number 5
- password
  - for SIP server login 30
  - login 20
  - restoring the default 18
- payload types 5
- pcb dimensions and intrusion sensor range 71
- play audio locally (door sensor) 38
- play audio locally (intrusion sensor) 38
- play tone during DTMF activation 24
- point-to-point configuration 32
- port
  - local SIP 30
  - remote SIP 30
- posix timezone string
  - timezone string 52
- POST command 62
- power requirement 5

- priority
  - assigning 40
- product
  - configuring 18
  - mounting 66
  - parts list 6
- product features 3
- product overview
  - product features 3
  - product specifications 5
  - supported protocols 4
  - supported SIP servers 4
  - typical system installation 2
- product specifications 5
- protocol 5
- protocols supported 4

## R

- reboot 60, 61
- regulatory compliance 5
- remote SIP port 30
- reset test function management button 16
- resetting the IP address to the default 66, 73
- restoring factory default settings 17, 77
- restoring the factory default settings 17
- return and restocking policy 76
- ringtones 40
  - lengthy pages 40
- RJ-45 14
- RMA returned materials authorization 74
- RMA status 74
- rport discovery setting, disabling 31
- RTFM button 16
- RTFM jumper 16, 17
- RTP/AVP 4

## S

- sales 74
- sensor setup page 37
- sensor setup parameters 36
- sensors 38
- server address, SIP 30
- service 74
- set the time from the NTP server 52
- set time with external NTP server on boot 52
- setting up an intercom 9
- settings, default 17
- SIP
  - enable SIP operation 30
  - local SIP port 30

- user ID 30
- SIP (session initiation protocol) 4
- SIP configuration 29
  - SIP Server 30
- SIP configuration parameters
  - outbound proxy 30, 35
  - registration and expiration, SIP server lease 30, 35
  - user ID, SIP 30
- SIP registration 30
- SIP remote SIP port 30
- SIP server 30
  - password for login 30
  - SIP servers supported 4
  - user ID for login 30
- SIP settings 31
- SIP volume 24
- Spare in the Air Policy 76
- speaker output 5
- SRST 30
- static IP addressing 28
- subnet mask 18, 28
- supported protocols 4

## T

- tech support 74
- technical support, contact information 74
- terminal block, 16 AWG gauge wire 9
- TFTP server 4, 72
- time zone string examples 57

## U

- user ID
  - for SIP server login 30
- username
  - changing for web configuration access 23
  - default for web configuration access 20
  - restoring the default 18

## V

- verifying
  - baud rate 15
  - network connectivity 15
- VLAN ID 28
- VLAN Priority 28
- VLAN tagging support 28
- VLAN tags 28
- volume
  - microphone gain 24

- multicast volume 24
- ring volume 24
- sensor volume 24
- SIP volume 24
- volume boost 24

## W

- wall cutout dimensions 70, 71
- wall cutout dimensions, maximum recommended 70
- wall mounting option 68
- warranty 75
- warranty & RMA returns outside of the United States 76
- warranty and RMA returns page 76
- warranty policy at CyberData 75
- web access password 18
- web access username 18
- web configuration log in address 20
- web page
  - navigation 19
- web page navigation 19
- web-based intercom configuration 18
- weight 5
- wget, free unix utility 62
- Windows, setting up a TFTP server on 72
- wiring the circuit 11
  - devices less than 1A at 30 VDC 11

## Y

- yellow act light 15