

## Mounting

You have the option to use the following mounting template to mark, and then drill two 3/16-inch (0.1875-inch) holes for the mounting anchors.

To install and mount the SIP Paging Adapter:

1. Install the mounting anchors in the holes, and position the SIP Paging Adapter mounting holes over the anchors.
2. Use the two #6 sheet metal screws to secure the SIP Paging Adapter onto the mounting surface.

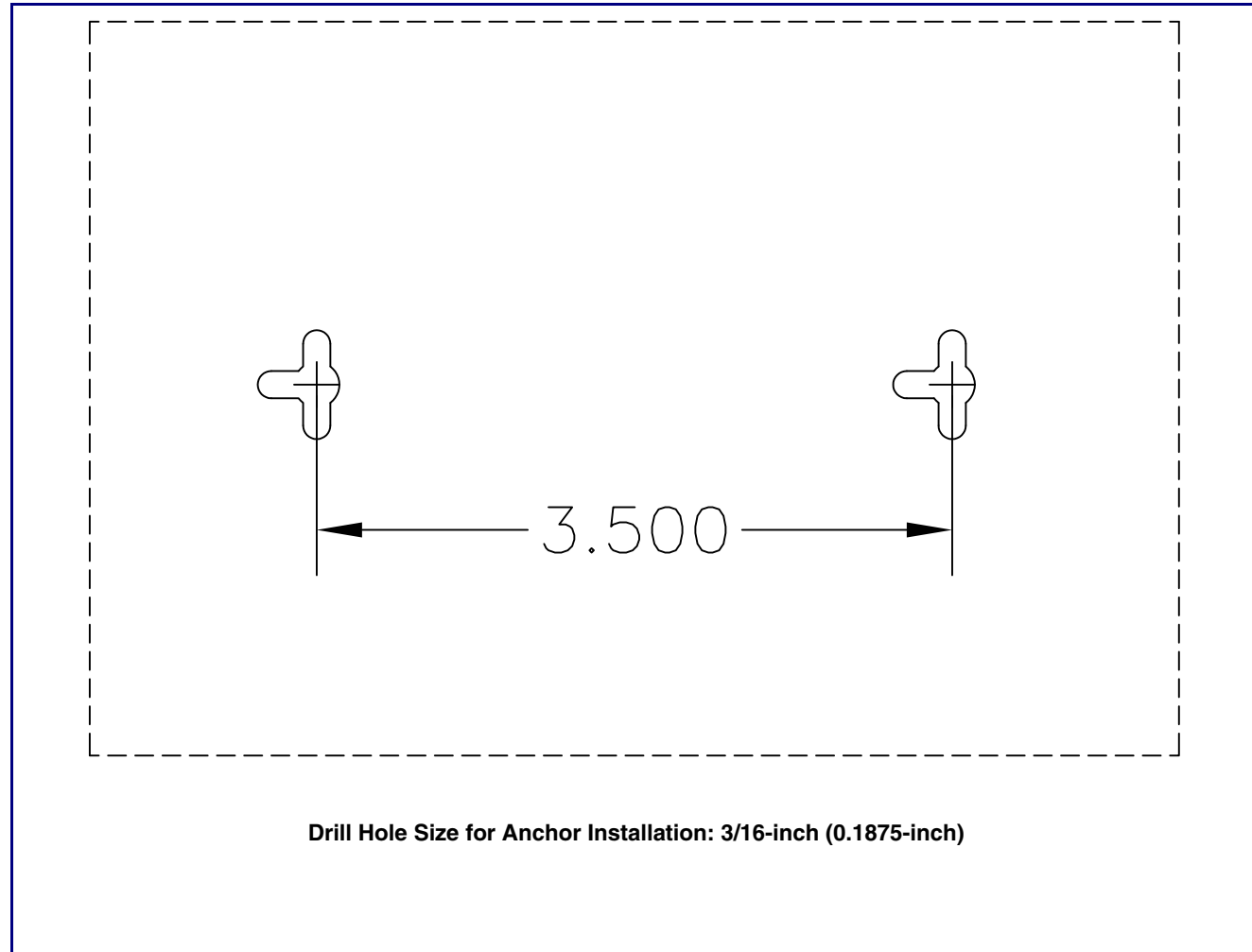

## Dimensions

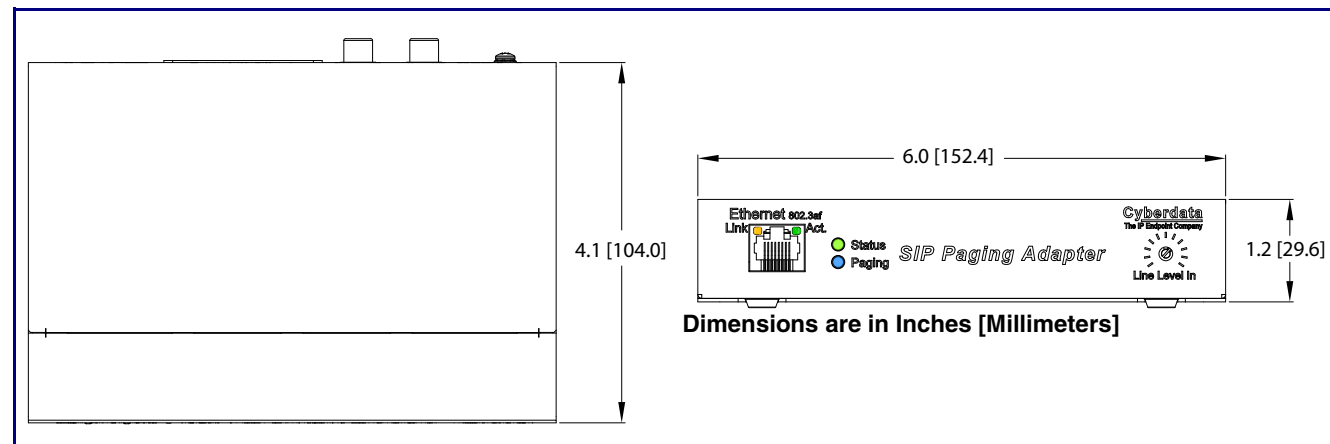

**CyberData**  
The IP Endpoint Company

Installation Quick Reference

# SIP Paging Adapter

SIP Compliant

## 011233

Parameter	Factory Default Setting
IP Addressing	DHCP
IP Address <sup>a</sup>	10.10.10.10
Web Access Username	admin
Web Access Password	admin
Subnet Mask <sup>a</sup>	255.0.0.0
Default Gateway <sup>a</sup>	10.0.0.1

a. Default if there is not a DHCP server present.



## Getting Started

- Be sure that you have received all the parts described in the [Parts List](#) section.
- Download the *Operations Guide* at the following website:  
<http://www.cyberdata.net/products/voip/legacyanalog/sippagingadapter/docs.html>
- **WARNING: This product should be installed by a licensed electrician according to all local electrical and building codes.**
- **WARNING: To prevent injury, this apparatus must be securely attached to the floor/wall in accordance with the installation instructions.**
- **WARNING: The PoE connector is intended for intra-building connections only and does not route to the outside plant.**
- **WARNING: This enclosure is not rated for any AC voltages!**

## Parts List

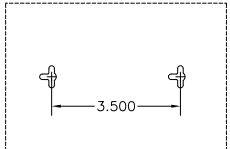
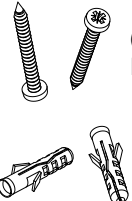
<b>(1) SIP Paging Adapter</b> 	<b>(1) Mounting Template</b> (see the last page) 	<b>(1) Mounting Kit</b>  <b>(2) #6 x1.25-inch, PanHead, Phillips Sheet Metal Screw</b>  <b>(2) Plastic Anchors</b>
--	--	---

## Contacting CyberData

### Corporate Headquarters

CyberData Corporation  
3 Justin Court  
Monterey, CA 93940, USA

Phone: 831-373-2601  
Fax: 831-373-4193  
[www.CyberData.net](http://www.CyberData.net)

Sales: (831) 373-2601 ext. 334  
Support: 831-373-2601 ext. 333  
Web: <http://www.cyberdata.net/support/contactsupportvoip.php>  
RMA Dept: (831) 373-2601 ext. 136  
Email: [RMA@CyberData.net](mailto:RMA@CyberData.net)  
RMA Status: <http://www.cyberdata.net/support/rmastatus.html>

Warranty and RMA information is available at the following website:  
<http://www.cyberdata.net/support/warranty/index.html>

## Verifying Operations and Settings

When you plug in the Ethernet cable or power supply:

- The **GREEN/BLUE Status LED** and the **GREEN Paging LED** both blink at a rate of 10 times per second during the initial network setup.
- The round, **GREEN/BLUE Status LED** on the front of the SIP Paging Adapter comes on indicating that the power is on. Once the device has been initialized, this LED blinks at one second intervals.
- The square, **GREEN/AMBER Link LED** above the Ethernet port indicates that the network connection has been established. The Link LED changes color to confirm the auto-negotiated connection speed:
  - The Link LED is **GREEN** at 10 Mbps.
  - The Link LED is **AMBER** at 100 Mbps.
- The **GREEN Paging LED** comes on after the device is booted and initialized. This LED blinks when a page is in progress. You can disable **Beep on Initialization** on the **Device Configuration** page.

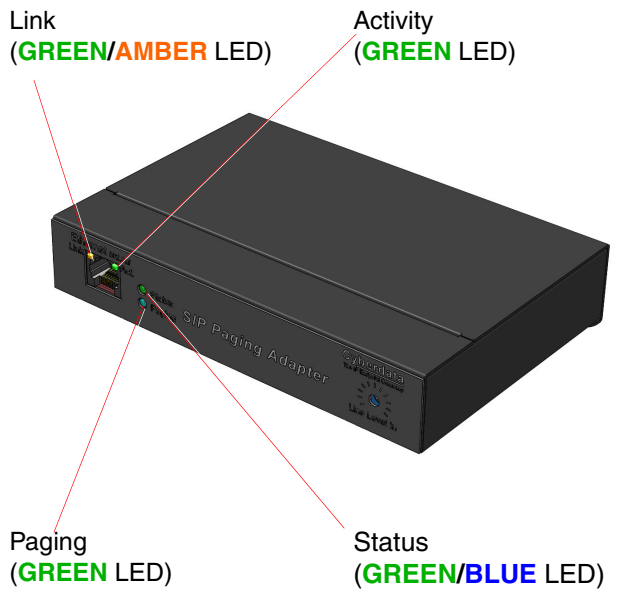

## Setting Up the SIP Paging Adapter

**PoE**



**Non PoE with 48 VDC Power Supply**



**Chassis Ground**



To set up the SIP Paging Adapter, connect the device to your network:

**PoE**

- For **PoE**, plug one end of an 802.3af Ethernet cable into the SIP Paging Adapter Ethernet port. Plug the other end of the Ethernet cable into your network. See the figure on the left.

**Non-PoE**

- For **Non-PoE**, connect the SIP Paging Adapter to a **48VDC power supply**. See the figure on the left.

**Chassis Ground**

- If required, connect the earth grounding wire to the **Chassis Ground**. See the figure on the left.

## Connections

Page Port Output Connections	
Pin	Description
1	Fault Sense Input (Common)
2	Fault Sense Input (Sense)
3	Positive 600-Ohm Audio Output <sup>a</sup>
4	Negative 600-Ohm Audio Output <sup>a</sup>
5	Audio Ground Reference
6	Relay Contact - Common <sup>b</sup>
7	Relay Contact - Normally Open <sup>b</sup>

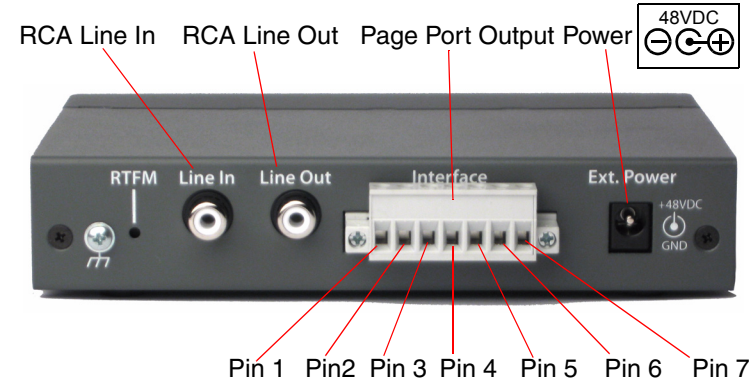

<sup>a</sup> The 600-Ohm audio output of the page port is also suited for interfaces with lower input impedances.

<sup>b</sup> 1 Amp at 30 VDC for continuous loads

## RTFM Switch

**To announce the IP address:**

- Briefly press and then quickly release the RTFM switch.

**Note:** The IP address announcement can be heard if a speaker or amplified speaker is connected to the unit.

**To restore the factory default settings:**

- Press and hold the **RTFM** switch while all the indicator lights turn off.
- Continue to press the switch until after the indicator lights turn back on, and then release the switch.
- All SIP Paging Adapter settings are restored to the factory defaults, and the unit reboots.

**Note:** The "Restoring Defaults" announcement can be heard if a speaker or amplified speaker is connected to the unit.



RTFM Switch

## Typical Configuration

