

SIP Speaker

SIP Compliant

011393*, RAL 9002, Gray White, Standard
011394*, RAL 9003, Signal White, Optional

*Replaces the 011098 and 011099 numbers.



Parameter	Factory Default Setting
IP Addressing	DHCP
IP Address ^a	10.10.10.10
Web Access Username	admin
Web Access Password	admin
Subnet Mask ^a	255.0.0.0
Default Gateway ^a	10.0.0.1

a. Default if there is not a DHCP server present.

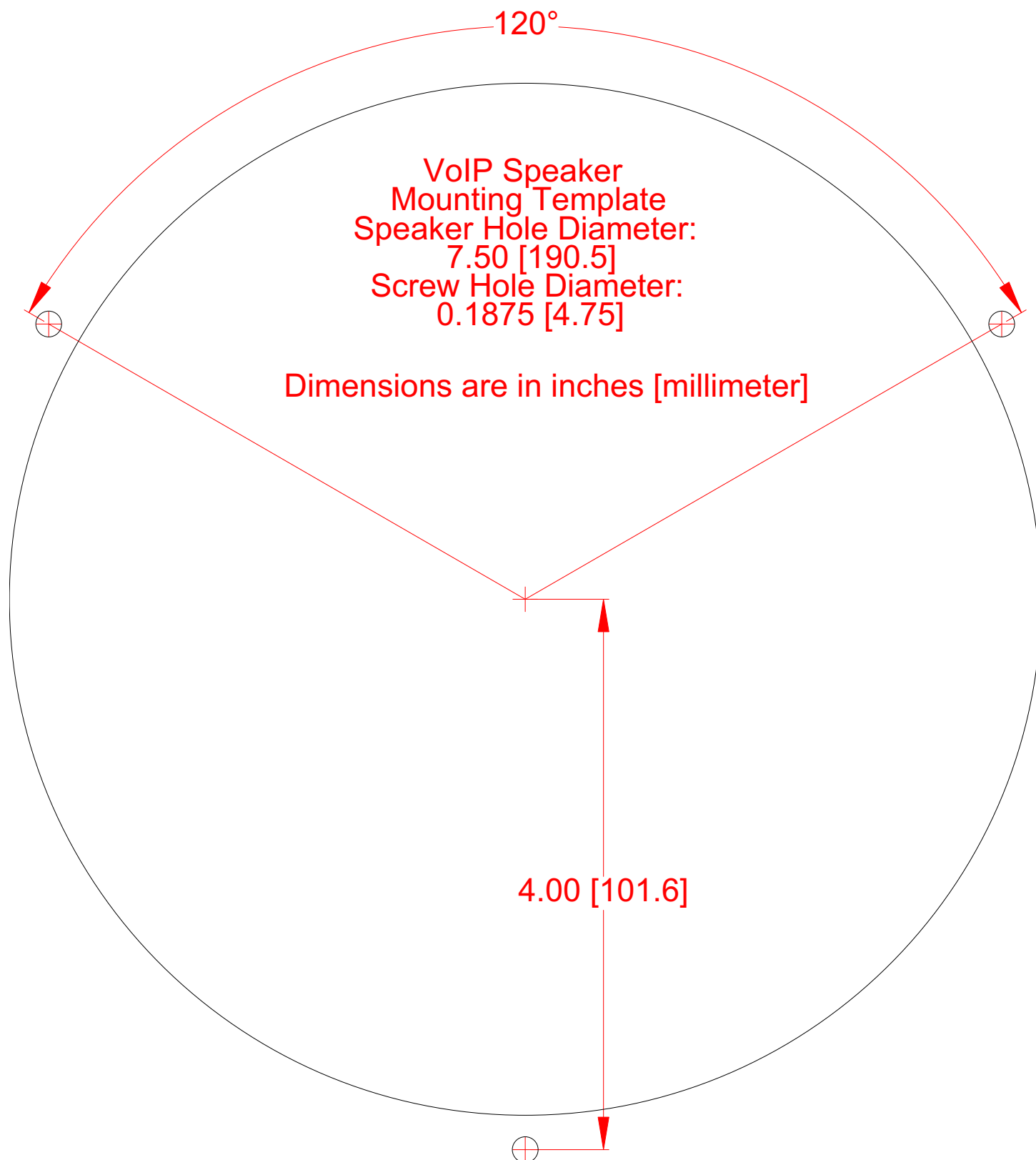



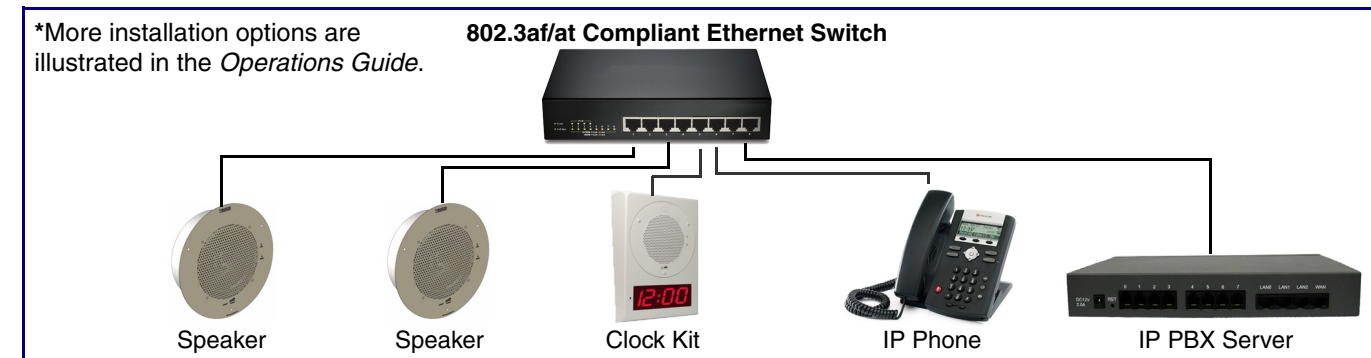



Typical System Installation

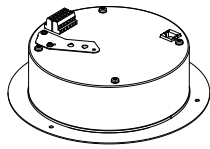
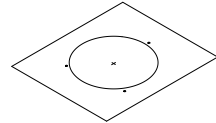

Getting Started

- Download the *Operations Guide* PDF file, from the **Downloads** tab at the following webpage:
<http://www.cyberdata.net/voip/011393/>
- Create a plan for the locations of your SIP Speakers.
- **WARNING:** This product should be installed by a licensed electrician according to all local electrical and building codes.
- **WARNING:** To prevent injury, this apparatus must be securely attached to the floor/wall in accordance with the installation instructions.
- **WARNING:** The PoE connector is intended for intra-building connections only and does not route to the outside plant.
- **WARNING:** This enclosure is not rated for any AC voltages!

Parts

<p>(1) Speaker Assembly</p> 	<p>(1) Template for Speaker and Screw Holes*</p>  <p><i>* See the last page of this document</i></p>	<p>(1) Drop Ceiling Mounting Kit</p> <p>(3) #8 Nylon Thumb Nuts </p> <p>(3) #8 Fender Washers </p> <p>(3) 8-32 x 1 1/4" Mounting Screws </p>	<p>(1) Drywall Mounting Kit</p> <p>(3) Plastic Ribbed Anchors </p> <p>(3) #8 Sheet Metal Screws </p>
--	--	--	---

Dimensions and Connections

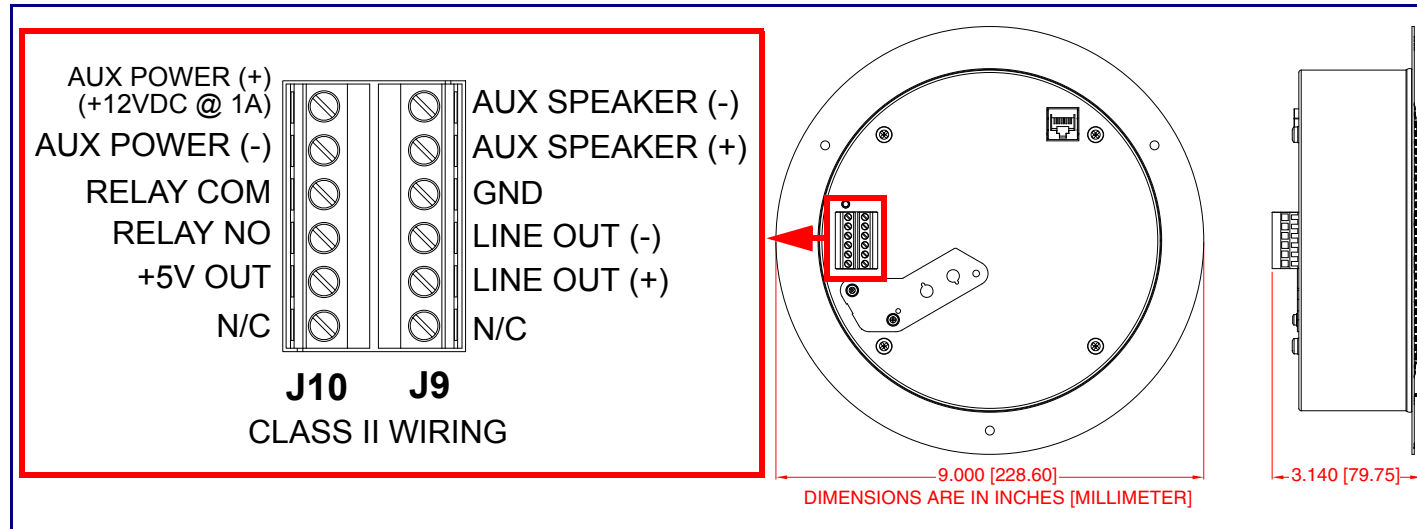

Connecting Power

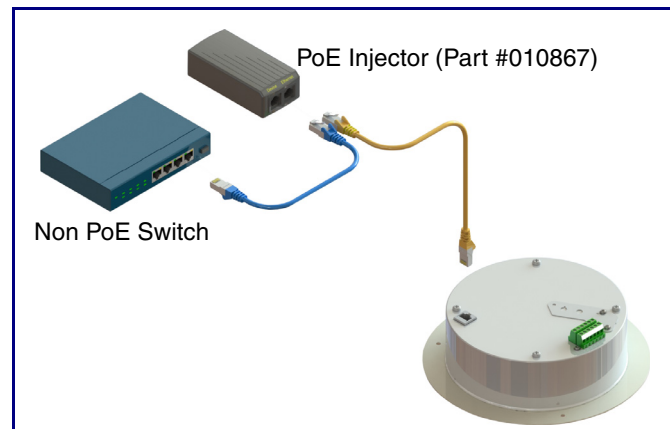
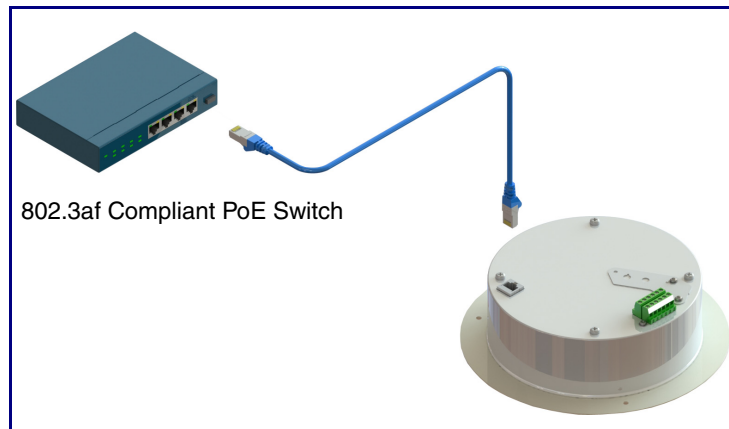

Features

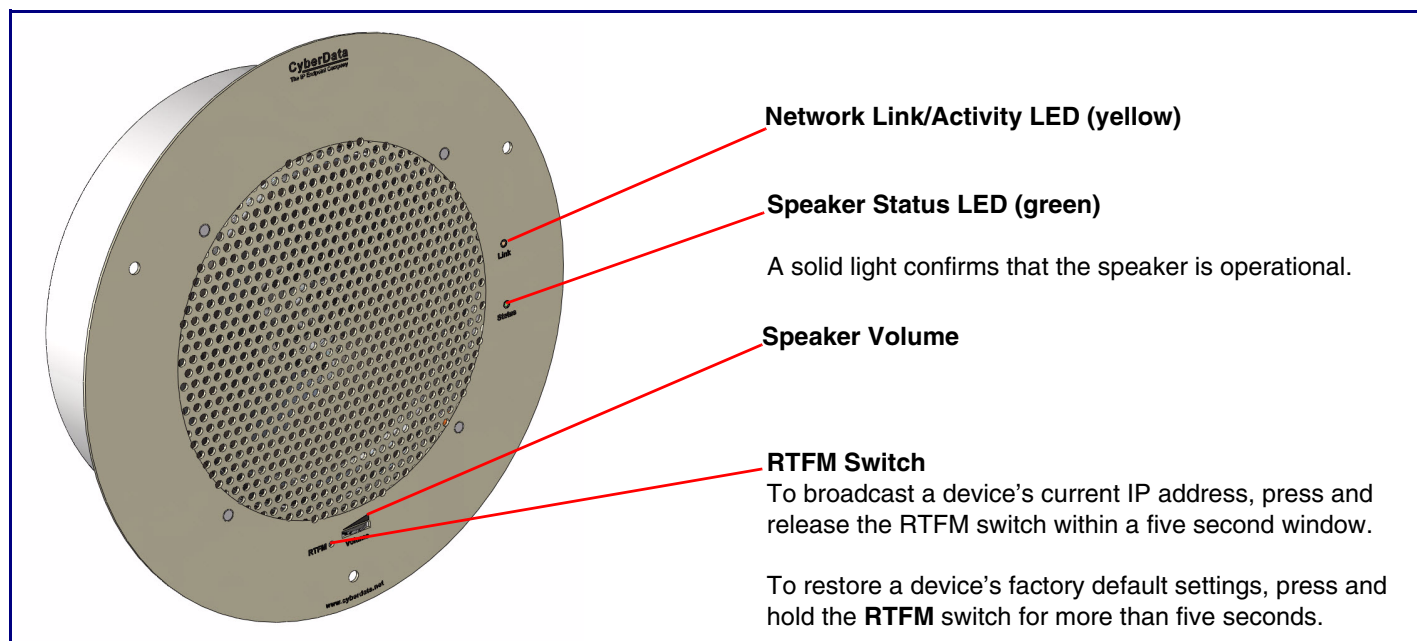

Mounting

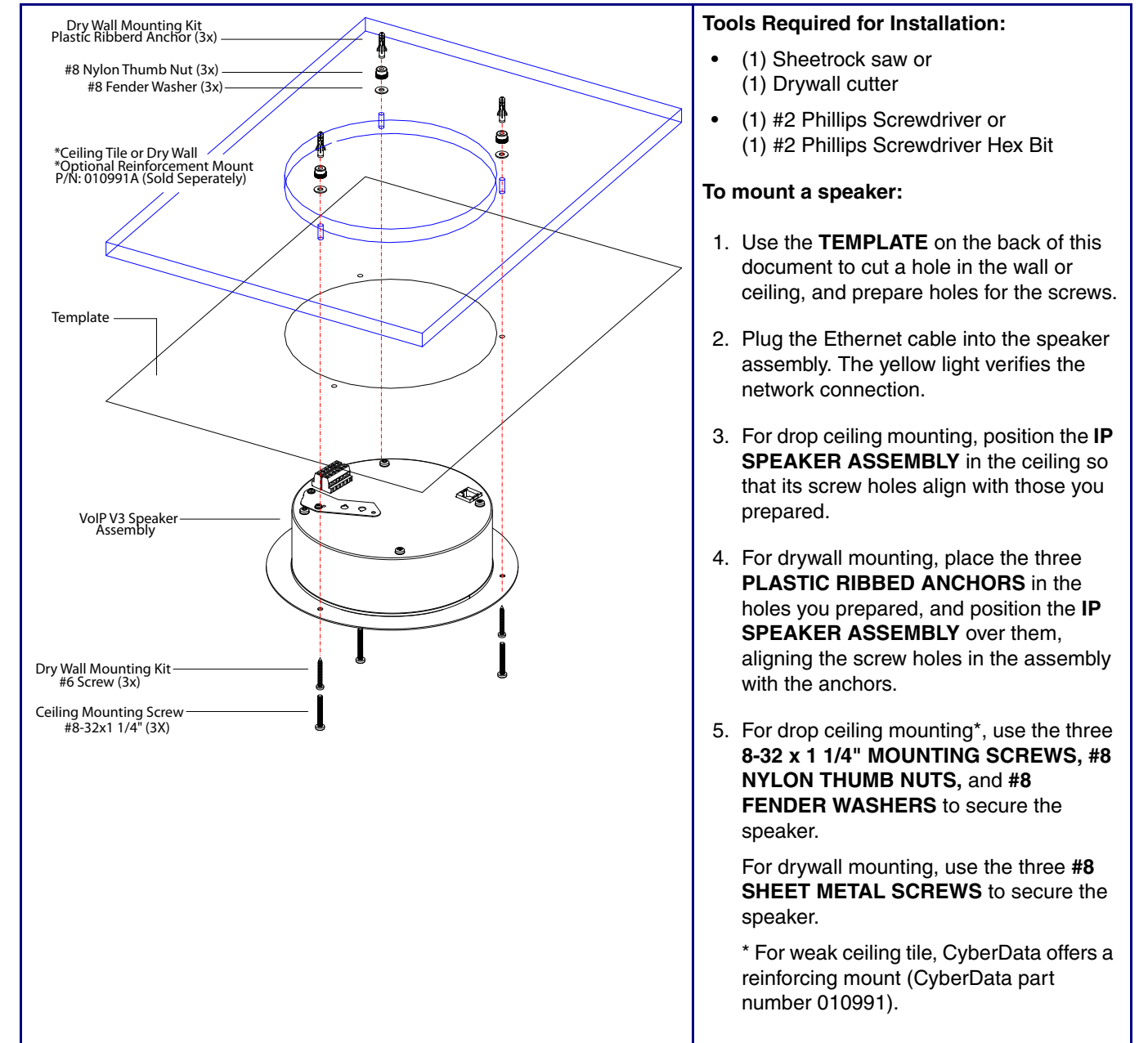

Contacting CyberData

Corporate Headquarters

CyberData Corporation
3 Justin Court
Monterey, CA 93940, USA

Phone: 831-373-2601
Fax: 831-373-4193
<http://www.cyberdata.net/>

Sales: (831) 373-2601 ext. 334
Support: 831-373-2601 ext. 333
Support Website: <http://support.cyberdata.net/>
RMA Department: (831) 373-2601 ext. 136
RMA Email: RMA@CyberData.net
RMA Status: <http://support.cyberdata.net/>
Warranty Information: <http://support.cyberdata.net/>