



# *Singlewire InformaCast Talk-Back Speaker Operations Guide*

Part Number  
**011399\***, RAL 9002, Gray White, Standard  
**011400\***, RAL 9003, Signal White, Optional

\*Replaces #011182 and 011183

Document Part #931260A  
for Firmware Version 11.6.3

**CyberData Corporation**  
3 Justin Court  
Monterey, CA 93940  
(831) 373-2601

---

---

**Singlewire InformaCast Talk-Back Speaker Operations Guide 931260A**

**Part #**

**011399, RAL 9002, Gray White, Standard**

**011400, RAL 9003, Signal White, Optional**

**COPYRIGHT NOTICE:**

© 2016, CyberData Corporation, ALL RIGHTS RESERVED.

This manual and related materials are the copyrighted property of CyberData Corporation. No part of this manual or related materials may be reproduced or transmitted, in any form or by any means (except for internal use by licensed customers), without prior express written permission of CyberData Corporation. This manual, and the products, software, firmware, and/or hardware described in this manual are the property of CyberData Corporation, provided under the terms of an agreement between CyberData Corporation and recipient of this manual, and their use is subject to that agreement and its terms.

**DISCLAIMER:** Except as expressly and specifically stated in a written agreement executed by CyberData Corporation, CyberData Corporation makes no representation or warranty, express or implied, including any warranty or merchantability or fitness for any purpose, with respect to this manual or the products, software, firmware, and/or hardware described herein, and CyberData Corporation assumes no liability for damages or claims resulting from any use of this manual or such products, software, firmware, and/or hardware. CyberData Corporation reserves the right to make changes, without notice, to this manual and to any such product, software, firmware, and/or hardware.

**OPEN SOURCE STATEMENT:** Certain software components included in CyberData products are subject to the GNU General Public License (GPL) and Lesser GNU General Public License (LGPL) "open source" or "free software" licenses. Some of this Open Source Software may be owned by third parties. Open Source Software is not subject to the terms and conditions of the CyberData COPYRIGHT NOTICE or software licenses. Your right to copy, modify, and distribute any Open Source Software is determined by the terms of the GPL, LGPL, or third party, according to who licenses that software.

Software or firmware developed by CyberData that is unrelated to Open Source Software is copyrighted by CyberData, subject to the terms of CyberData licenses, and may not be copied, modified, reverse-engineered, or otherwise altered without explicit written permission from CyberData Corporation.

**TRADEMARK NOTICE:** CyberData Corporation and the CyberData Corporation logos are trademarks of CyberData Corporation. Other product names, trademarks, and service marks may be the trademarks or registered trademarks of their respective owners.

**CyberData**

The IP Endpoint Company

Technical Support

The fastest way to get technical support for your VoIP product is to submit a VoIP Technical Support form at the following website:

<http://support.cyberdata.net/>

Phone: (831) 373-2601, Ext. 333

Email: [support@cyberdata.net](mailto:support@cyberdata.net)

Fax: (831) 373-4193

Company and product information is at [www.cyberdata.net](http://www.cyberdata.net).

---

---

## Revision History

Revision 931260A, which corresponds to firmware version 11.6.3, was released on November 18, 2016 and has the following changes:

- Updates [Figure 1-3, "Optional Connections \(J9 and J10\)"](#).
- Updates [Figure 2-4, "Running the Speaker with Auxiliary Power"](#).
- Updates [Figure 2-5, "Running the Speaker with a Remote Call Button"](#).
- Updates [Figure 2-6, "Speaker with an External Device"](#).
- Updates [Figure 2-7, "Singlewire InformaCast Talk-Back Speaker with Auxiliary Speaker Connection"](#).
- Updates [Figure 2-8, "Singlewire InformaCast Talk-Back Speaker with Line Out"](#).

---

---

## Browsers Supported



The following browsers have been tested against firmware version 11.6.3:

- Internet Explorer (version: 10)
- Firefox (also called Mozilla Firefox) (version: 23.0.1)
- Chrome (version: 29.0.154.66 m)
- Safari (version: 5.1.7)

---



# Important Safety Instructions

1. Read these instructions.
2. Keep these instructions.
3. Heed all warnings.
4. Follow all instructions.
5. Do not use this apparatus near water.
6. Clean only with dry cloth.
7. Do not block any ventilation openings. Install in accordance with the manufacturer's instructions.
8. Do not install near any heat sources such as radiators, heat registers, stoves, or other apparatus (including amplifiers) that produce heat.
9. Do not defeat the safety purpose of the polarized or grounding-type plug. A polarized plug has two blades with one wider than the other. A grounding type plug has two blades and a third grounding prong. The wide blade or the third prong are provided for your safety. If the provided plug does not fit into your outlet, consult an electrician for replacement of the obsolete outlet.
10. Protect the power cord from being walked on or pinched particularly at plugs, convenience receptacles, and the point where they exit from the apparatus.
11. Only use attachments/accessories specified by the manufacturer.
12. Refer all servicing to qualified service personnel. Servicing is required when the apparatus has been damaged in any way, such as power-supply cord or plug is damaged, liquid has been spilled or objects have fallen into the apparatus, the apparatus has been exposed to rain or moisture, does not operate normally, or has been dropped.
13. Prior to installation, consult local building and electrical code requirements.

 <p>GENERAL ALERT</p>	<p><b>Warning</b> <i>Electrical Hazard:</i> This product should be installed by a licensed electrician according to all local electrical and building codes.</p>
 <p>GENERAL ALERT</p>	<p><b>Warning</b> <i>Electrical Hazard:</i> To prevent injury, this apparatus must be securely attached to the floor/wall in accordance with the installation instructions.</p>

---

## Pictorial Alert Icons

	<p><b>General Alert</b></p> <p><i>This pictorial alert indicates a potentially hazardous situation. This alert will be followed by a hazard level heading and more specific information about the hazard.</i></p>
	<p><b>Ground</b></p> <p><i>This pictorial alert indicates the Earth grounding connection point.</i></p>

---

## Hazard Levels

**Danger:** Indicates an imminently hazardous situation which, if not avoided, will result in death or serious injury. This is limited to the most extreme situations.

**Warning:** Indicates a potentially hazardous situation which, if not avoided, could result in death or serious injury.

**Caution:** Indicates a potentially hazardous situation which, if not avoided, could result in minor or moderate injury. It may also alert users against unsafe practices.

**Notice:** Indicates a statement of company policy (that is, a safety policy or protection of property).

The safety guidelines for the equipment in this manual do not purport to address all the safety issues of the equipment. It is the responsibility of the user to establish appropriate safety, ergonomic, and health practices and determine the applicability of regulatory limitations prior to use. Potential safety hazards are identified in this manual through the use of words Danger, Warning, and Caution, the specific hazard type, and pictorial alert icons.

---

## 1.1 Abbreviations and Terms

<b>Abbreviation or Term</b>	<b>Definition</b>
A-law	A standard companding algorithm, used in European digital communications systems to optimize, i.e., modify, the dynamic range of an analog signal for digitizing.
AVP	Audio Video Profile
Cat 5	TIA/EIA-568-B Category 5
DHCP	Dynamic Host Configuration Protocol
LAN	Local Area Network
LED	Light Emitting Diode
Mbps	Megabytes per Second.
NTP	Network Time Protocol
PBX	Private Branch Exchange
PoE	Power over Ethernet (as per IEEE 802.3af standard)
RTP	Real-time Transport Protocol
RTFM	Reset Test Function Management
Talkback	Two-way communication enabled
TFTP	Trivial File Transfer Protocol
u-law	A companding algorithm, primarily used in the digital telecommunication
UC	Unified Communications
VoIP	Voice over Internet Protocol

# Contents

<b>Chapter 1 Product Overview</b>	<b>1</b>
1.1 How to Identify This Product .....	1
1.2 Installation .....	2
1.3 Product Features .....	3
1.4 Supported Protocols .....	4
1.5 Product Specifications .....	5
1.6 Optional Connections (J9 and J10) .....	6
1.7 Starting a Push-to-Talk Session from an IP Phone (Summary) .....	7
1.8 Starting a Push-to-Talk Session from a Singlewire InformaCast Talk-Back Speaker (Summary) .....	7
1.9 Starting a Push-to-Talk Session from an IP Phone (Detailed) .....	8
1.10 Starting a Push-to-Talk Session from a Singlewire InformaCast Talk-Back Speaker (Detailed) .....	15
1.10.1 Optional 011185 Remote Call Button (sold separately) .....	15
1.10.2 Procedure .....	15
<b>Chapter 8 Installing the Singlewire InformaCast Talk-Back Speaker</b>	<b>21</b>
2.1 Parts List .....	21
2.2 Device Configuration .....	22
2.2.1 Connect Power to the Speaker .....	23
2.2.2 Installation Options .....	26
2.2.3 Confirm that the Speaker is Operational and Linked to the Network .....	30
2.2.4 Confirm the IP Address and Test the Audio .....	31
2.2.5 Adjust the Volume .....	32
2.2.6 How to Set the Factory Default Settings .....	33
2.3.1 Factory Default Settings .....	34
2.3.2 Singlewire InformaCast Talk-Back Speaker Web Page Navigation .....	35
2.3.3 Using the Toggle Help Button .....	36
2.3.4 Log in to the Configuration Home Page .....	38
2.3.5 Configure the Device .....	42
2.3.6 Configure the Network Parameters .....	52
2.3.7 Configure the SIP (Session Initiation Protocol) Parameters .....	55
2.3.8 Configure the Multicast Parameters .....	65
2.3.9 Configure the Sensor Configuration Parameters .....	69
2.3.10 Configure the Audio Configuration Parameters .....	73
2.3.11 Configure the Events Parameters .....	78
2.3.12 Configure the Autoprovisioning Parameters .....	84
2.4.1 Downloading the Firmware .....	96
2.4.2 Reboot the Device .....	98
2.5.1 Command Interface Post Commands .....	99
2.3 Identifying and Testing a Ceiling Speaker when Using InformaCast 8.1 or Later .....	103
<b>Appendix A Mounting the Speaker</b>	<b>109</b>
A.1 Mount the Speaker .....	109
<b>Appendix B Troubleshooting/Technical Support</b>	<b>112</b>
B.1 Frequently Asked Questions (FAQ) .....	112
B.2 Documentation .....	112
B.3 Contact Information .....	113
B.4 Warranty and RMA Information .....	113
<b>Index</b>	<b>114</b>

# 1 Product Overview

The CyberData Singlewire-enabled Singlewire InformaCast Talk-Back Speaker enables two-way conversations using the Singlewire Push-to-Talk application running on the phone. The Singlewire InformaCast Talk-Back Speaker easily connects into local area networks with a single CAT5/6 cable from your PoE switch. Its small footprint allows the speaker to be mounted almost anywhere with multiple mounting options available.

By use of the optional remote call button, calls to a predetermined extension can be initiated from the room with the speaker. During the active calls, the LED light on the switch can be programmed to blink to show call activity.

---

## 1.1 How to Identify This Product

To identify the Singlewire InformaCast Talk-Back Speaker, look for a model number label similar to the one shown in [Figure 1-1](#). The model number on the label should be one of the following:

- **011399**, RAL 9002, Gray White, Standard Color
- **011400**, RAL 9003, Signal White, Optional Color

**Figure 1-1. Model Number Label**

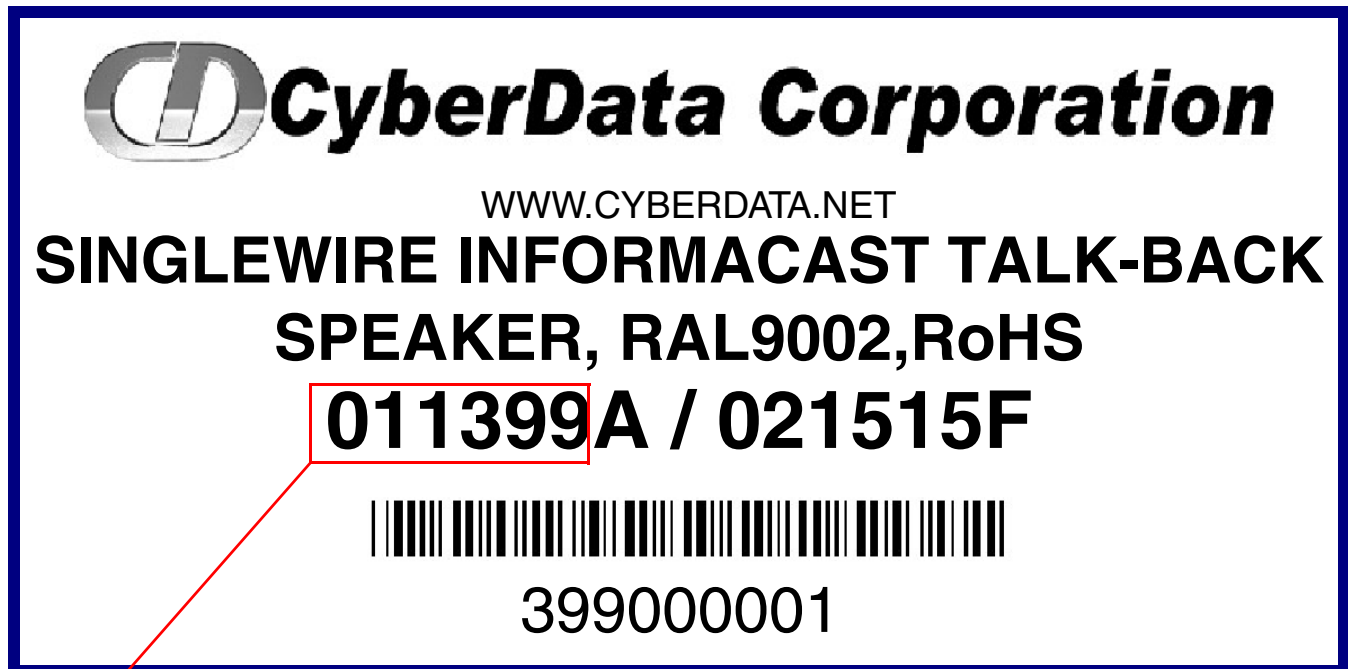

Model number



## 1.2 Installation

Figure 1-2 illustrates a typical configurations for the Singlewire InformaCast Talk-Back Speaker.

**Figure 1-2. Typical Installation**

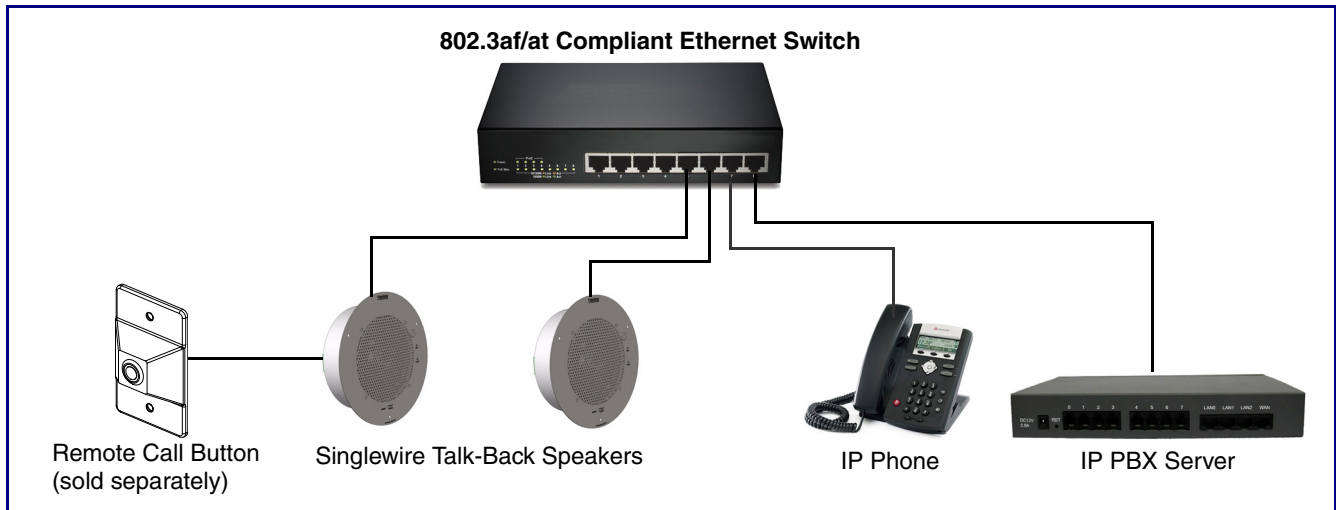

**Note** The version of InformaCast needs to be 4.0 or higher.

**Note** Prior to installation, create a plan for the locations of your speakers.

 <p>GENERAL ALERT</p>	<p>General Alert <i>Consult local building and electrical code requirements prior to installation.</i></p>
--	--

See the following sections for other installation options:

- [Section 2.2.1.3, "Running the Singlewire InformaCast Talk-Back Speaker with Auxiliary Power"](#)
- [Section 2.2.2.1, "Running the Singlewire InformaCast Talk-Back Speaker with a Remote Call Button"](#)
- [Section 2.2.2.3, "Singlewire InformaCast Talk-Back Speaker with Auxiliary Speaker Connection"](#)
- [Section 2.2.2.4, "Singlewire InformaCast Talk-Back Speaker with Line Out"](#)

---

## 1.3 Product Features

### **SIP Features**

- Singlewire speakers now offer dual registration for both SIP and Singlewire
- Full-duplex (SIP) or half-duplex (push to talk)
- Support for security code to prevent unwanted SIP calls
- Optional red/green/blue/white strobe kit connection available (coming soon)
- Autoprovisioning via HTTP, HTTPS, or TFTP
- HTTPS or HTTP web based configuration. HTTPS is enabled by default.
- 802.11q VLAN tagging
- Configurable sense input for use with fault detection or with optional lighted button kit
- Configurable event generation for device health and status monitoring
- Support for G.711 u-law, G.711 a-law, and G.722 codecs.
- Powered via PoE (802.3AF or 802.3AT) or 24V auxiliary power supply (not included)
- Enhanced interoperability for hosted environments
- Night Ringer function
- Plays audio from Multicast
- Web-based configuration
- Paging prioritization and background music
- User upgradeable firmware via web interface or autoprovisioning
- External volume control
- Small footprint
- High efficiency speaker driver
- IGMP | SIP endpoint or Multicast group member
- Network-adjustable speaker volume
- Optional auxiliary speaker available to increase audio coverage - Part #011120/011121
- Optional clock kit available - Part #011153/011154
- Support for 10 multicast paging groups
- Support for multiple SIP servers for redundancy
- Support for Cisco SRST resiliency
- Relay for activating door locks, external amplifiers, etc.
- Line-level audio output for connecting to an external amplifier

### **Singlewire InformaCast Features**

- Singlewire Informacast compatibility available. Includes support for Informacast resiliency.
- Supports both SIP and Singlewire InformaCast
- InformaCast compliant
- InformaCast CK compliant

---

## 1.4 Supported Protocols

The Singlewire InformaCast Talk-Back Speaker supports:

- Multicast
- DHCP Client
  - Dynamically assigns IP addresses in addition to the option to use static addressing.
- InformaCast Version 4.0 and greater
- TFTP Client
  - Facilitates Web-based firmware upgrades of the latest speaker capabilities.
- RTP
- Audio Encodings
  - PCMU (G.711 mu-law)
  - PCMA (G.711 A-law)
  - Packet Time 20 ms

## 1.5 Product Specifications

**Table 1-1. Product Specifications**

Category	Specification
Audio sensitivity	96dB/1W/1M S.P. Level
Audio output	10 Watts Peak Power
Operating temperature	-30 to 55 C (-22 to 131 F)
Ethernet port baud rate	10/100 Mbps
Protocol	InformaCast and/or SIP (RFC 3261)
Power Input (J1)	PoE 802.3af (as per IEEE 802.3af standard from a UL-listed, LPS-rated limited power source) 802.3at 44-57 VDC (48 VDC nominal) at 350mA
or Auxiliary Power Input <sup>a</sup> (Terminal Block J10)	12 VDC at 1A (from a UL-listed, LPS-rated power supply)
Total Power	~ 15W
Network Line loss	~ 2W
Total Pwr @ VoIP Speaker	~ 13W
Total available audio power	~ 10W
Idle PWR (losses/CPU)	~ 3W
Payload types	G.711 $\mu$ -law, G.711 a-law, and G.722
Warranty	2 years limited
Dimensions	9 in. [228.6 mm] x 2.4 in. [60.96 mm]
Weight	2.8 lbs./shipping weight of 3.8 lbs. (1.3 kg/shipping weight of 1.7 kg)
Part number	<b>011399*</b> , RAL 9002, Gray White, Standard Color <b>011400</b> , RAL 9003, Signal White, Optional Color *Replaces 011182 and 011183.

a. Auxiliary power input for use when PoE power is not available. 12 VDC @ 1A. Do not use auxiliary power input when speaker J1 is connected to a PoE power source.

## 1.6 Optional Connections (J9 and J10)

Figure 1-3. Optional Connections (J9 and J10)

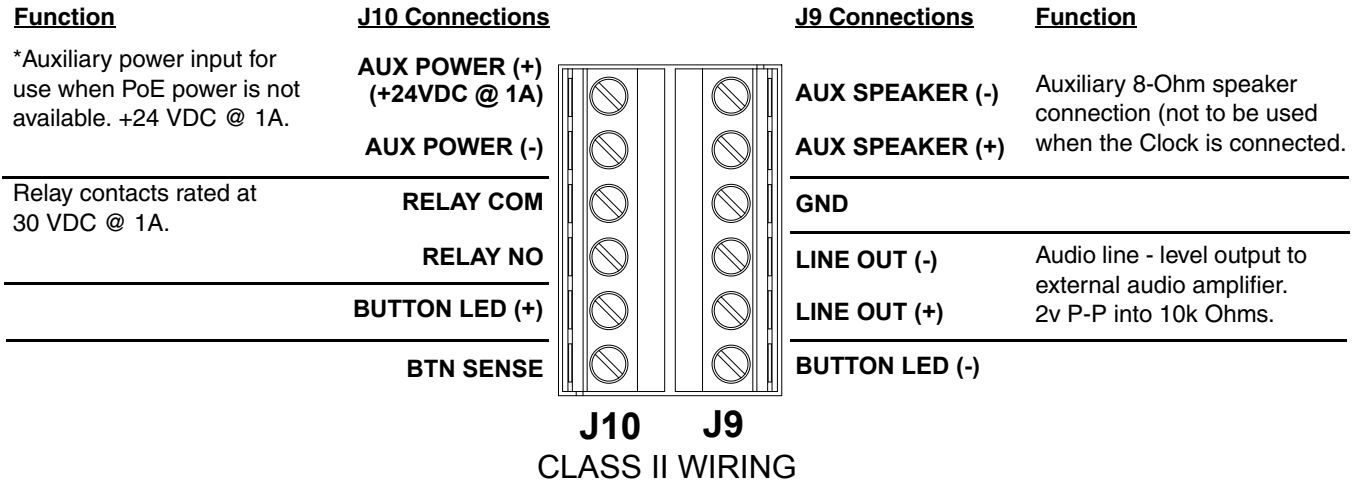

\*Do not use auxiliary power input when speaker J1 is connected to a PoE power source.

---

## 1.7 Starting a Push-to-Talk Session from an IP Phone (Summary)

### To start a push-to-talk session from an IP phone:

1. Make sure that the Cisco environment is set it up with the **Intercom Service**.
2. On the Cisco IP phone, select the **Service** button.
3. Select the **Informacast Intercom Service**.
4. On the Cisco IP phone, dial the extension number for the Speaker that you want to call.
5. When the call from the Cisco IP phone to the Speaker is active, you can do one of the following:
  - Select the **Listen** button on the phone to listen to someone talking into the Speaker.
  - Select the **Talk** button on the phone to talk to someone listening to the Speaker.

**Note** The IP phone always controls the talking and listening feature of the Speaker.

6. Select the **Exit** button to terminate the call.

**Note** For a more detailed explanation of this procedure with pictures, see [Section 1.9, "Starting a Push-to-Talk Session from an IP Phone \(Detailed\)"](#).

---

## 1.8 Starting a Push-to-Talk Session from a Singlewire InformaCast Talk-Back Speaker (Summary)

### To start a push-to-talk session from a Singlewire InformaCast Talk-Back Speaker:

1. Make sure that the Cisco environment is set it up with the **Intercom Service**.
2. Press the Remote Call Button to make the Singlewire InformaCast Talk-Back Speaker dial a pre-programmed IP phone extension.
3. When the call from the Singlewire InformaCast Talk-Back Speaker to the Cisco IP phone is active, you can do one of the following:
  - Select the **Listen** button on the phone to listen to someone talking into the Speaker.
  - Select the **Talk** button on the phone to talk to someone listening to the Speaker.

**Note** The IP phone always controls the talking and listening feature of the Speaker.

4. Select the **Exit** button to terminate the call.

**Note** For a more detailed explanation of this procedure with pictures, see [Section 1.10, "Starting a Push-to-Talk Session from a Singlewire InformaCast Talk-Back Speaker \(Detailed\)"](#).

## 1.9 Starting a Push-to-Talk Session from an IP Phone (Detailed)

### To start a Push-to-Talk Session from an IP Phone:

1. Press the **Services** button. In the Phone window, you will see the words **Informacast Intercom** listed under **Services**.
2. Press the button under the word **Select** in the phone window.

**Figure 2. Select the Informacast Intercom Service**



**Informacast Intercom** service

Button under **Select** in the phone window

**Services** button

3. When the words **Speaker Selection** and **Dial Code** appear in the phone window, use the keypad to enter the dial code for the preconfigured Singlewire InformaCast Talk-Back Speaker that you want to call.
4. After entering the dial code, press the button under the word **Submit** in the phone window to call the speaker.

**Figure 3. Enter the Dial Code**



**Speaker Selection**

Button under **Select** in the phone window



5. When the words **Talking to “Speaker Name”** appear in the phone window, the speaker is in *Talking Mode*. A person at the speaker can begin talking to the phone.

**Figure 4. Talking Mode**

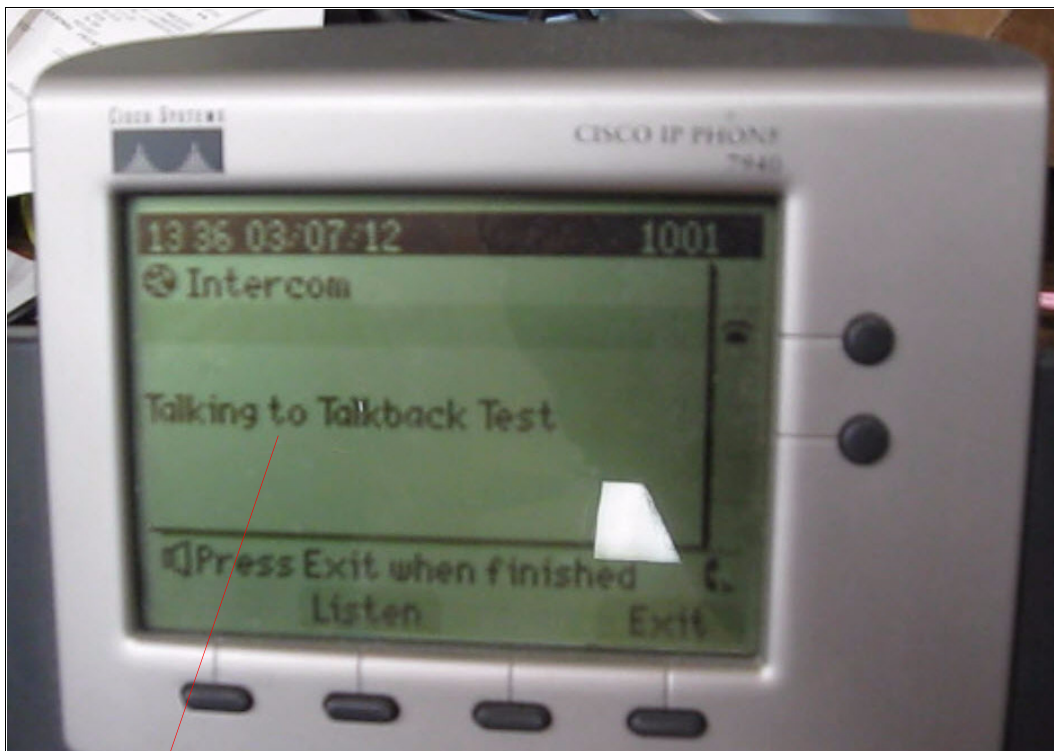

Talking to “Speaker Name”

6. If you want to switch the speaker to *Listening Mode*, the person at the phone must press the button under the word **Listen** that is in the phone window.

**Figure 5. Press the Listen Button to Switch to Listening Mode**



Button under **Listen** in the phone window

7. When the words **Listening to “Speaker Name”** appear in the phone window, the speaker is in *Listening Mode*. A person at the speaker can begin listening to someone talking through the phone.
8. If you want to switch the speaker back to *Talking Mode*, the person at the phone must press the button under the word **Talk** that is in the phone window.

**Figure 6. Listening Mode**

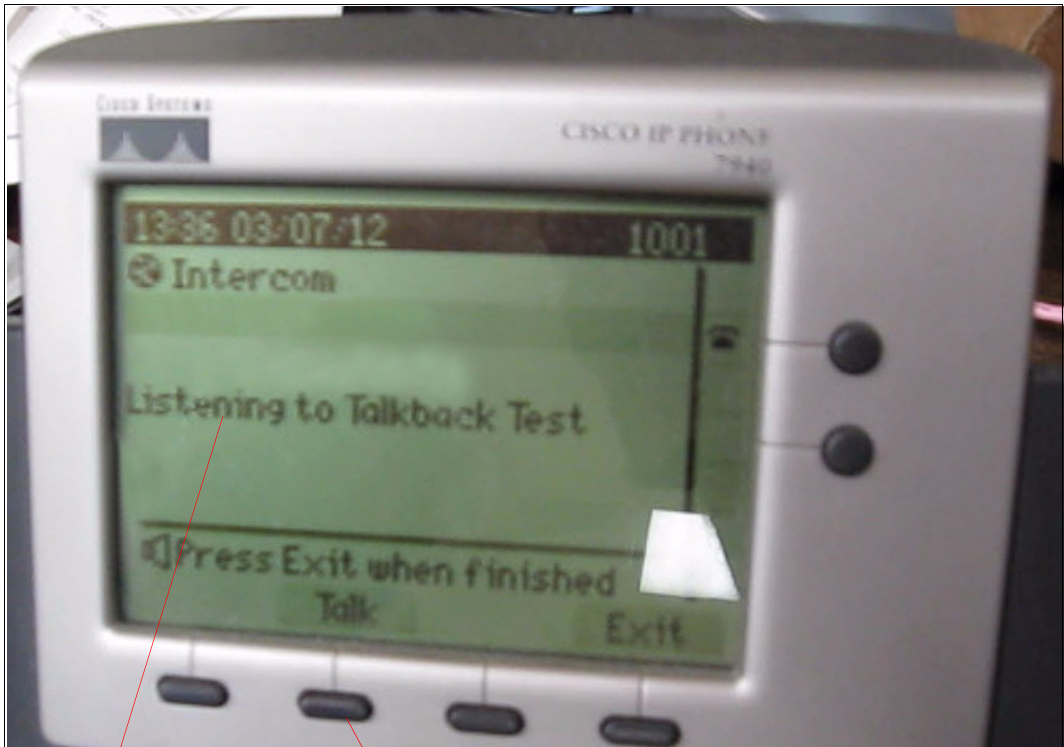

**Listening to “Speaker Name”** Button under **Talk** in the phone window

9. To end the call at any time, the person at the phone must press the button under the word **Exit** in the phone window.

Figure 7. Press Exit to End to End the Call



Button under **Exit** in the phone window

10. The person at the phone must then press the button under the word **Exit** in the phone window again to return to the **Home** screen.

**Figure 8. Press Exit Again to Return to the Home Screen**



Button under **Exit** in the phone window



---

## 1.10 Starting a Push-to-Talk Session from a Singlewire InformaCast Talk-Back Speaker (Detailed)

---

### 1.10.1 Optional 011185 Remote Call Button (sold separately)

Section 1.10, "Starting a Push-to-Talk Session from a Singlewire InformaCast Talk-Back Speaker (Detailed)" shows the optional 011185 Remote Call Button which is sold separately. For more information about this product, go to the following webpage:

<http://www.cyberdata.net/voip/011185/>

---

### 1.10.2 Procedure

To start a Push-to-Talk Session from a Singlewire InformaCast Talk-Back Speaker:

1. The person at the preconfigured Singlewire InformaCast Talk-Back Speaker must press the Remote Call Button. The speaker will immediately call a specific IP phone.

**Figure 9. Press the Remote Call Button**

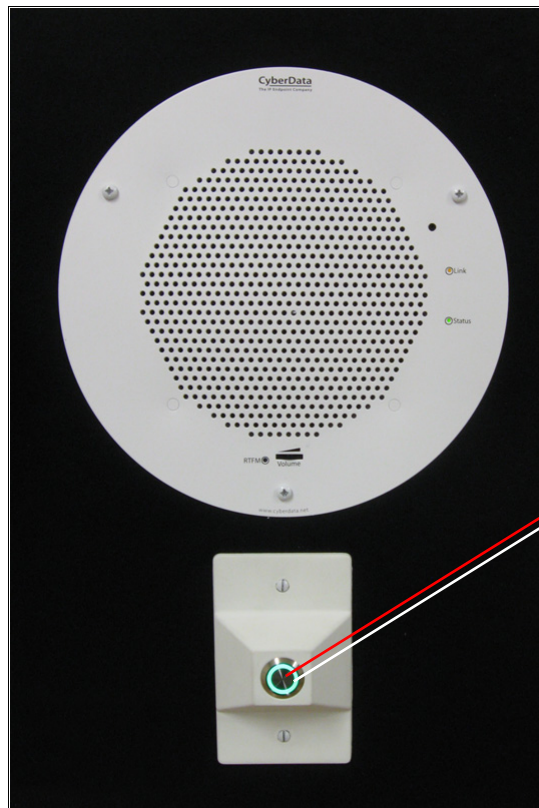

Remote Call Button  
**Note:** See Section 1.10.1, "Optional 011185 Remote Call Button (sold sepa-

- 2. When the words **Talking to Talkback Test** appear in the phone window, the speaker is in *Talking Mode*. A person at the speaker can begin talking to the phone.

**Figure 10. Talking Mode**

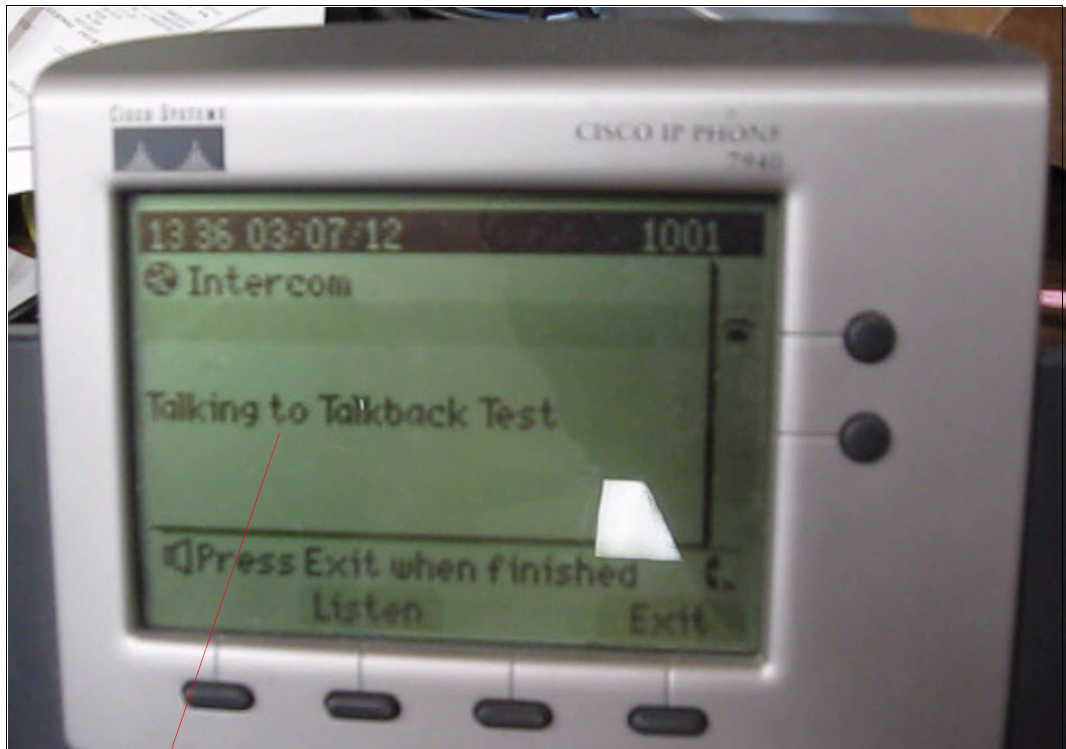

**Talking to Talkback Test**

3. If you want to switch the speaker to *Listening Mode*, the person at the phone must press the button under the word **Listen** that is in the phone window.

**Figure 11. Press the Listen Button to Switch to Listening Mode**



Button under **Listen** in the phone window



4. When the words **Listening to Talkback Test** appear in the phone window, the speaker is in *Listening Mode*. The person at the speaker can begin listening to someone talking through the phone.
5. If you want to switch the speaker back to *Talking Mode*, the person at the phone must press the button under the word **Talk** that is in the phone window.

**Figure 12. Listening Mode**

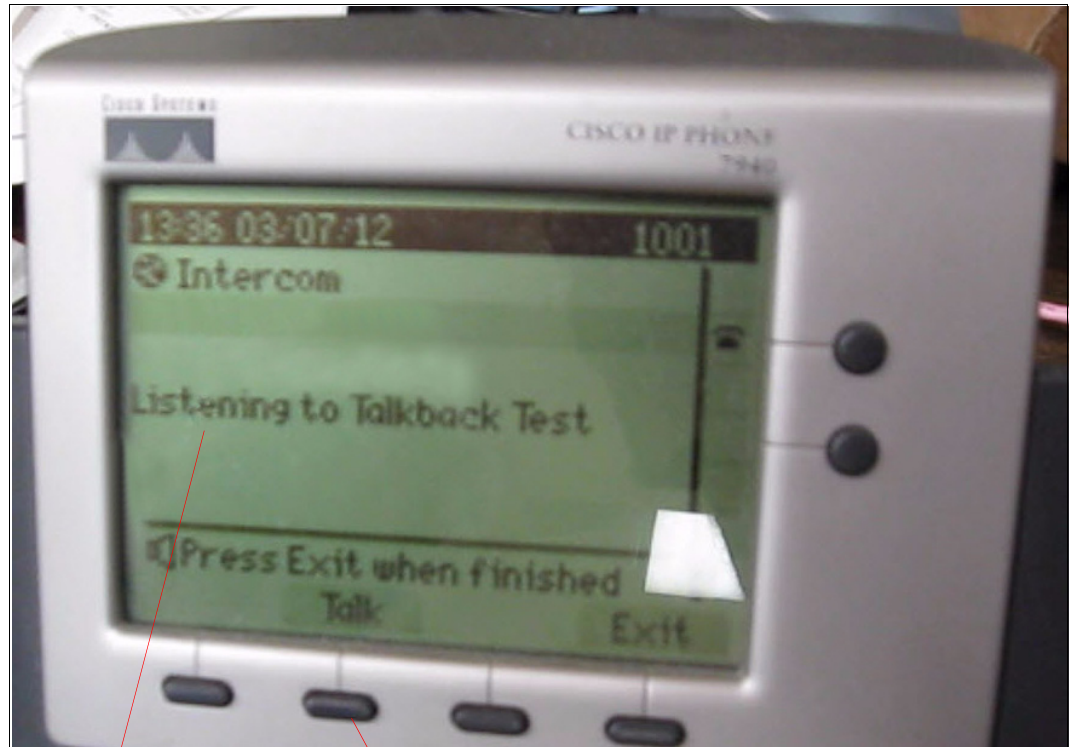

**Listening to Talkback Test**

**Button under **Talk** in the phone window**

6. To end the call at any time, the person at the phone must press the button under the word **Exit** in the phone window.

**Figure 13. Press Exit to End to End the Call**



Button under **Exit** in the phone window

7. The person at the phone must then press the button under the word **Exit** in the phone window again to return to the **Home** screen.

**Figure 1-1. Press Exit Again to Return to the Home Screen**



Button under **Exit** in the phone window



# 8 Installing the Singlewire InformaCast Talk-Back Speaker 21

## 2.1 Parts List

**Table 2-2** illustrates the parts for each speaker and includes kits for the drop ceiling and drywall mounting.

**Note** The installation template for the Singlewire InformaCast Talk-Back Speaker is located on the *Installation Quick Reference Guide* that is included in the packaging with each speaker.

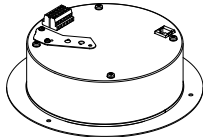
**Table 2-2. Parts**

Quantity	Part Name	Illustration
1	Singlewire InformaCast Talk-Back Speaker Assembly	
1	Installation Quick Reference Guide	
1	Speaker Mounting Accessory Kit	

---

## 2.2 Device Configuration

Set up and configure each speaker *before* you mount it.

CyberData delivers each speaker with the following factory default values:

**Table 2-3. Factory Network Default Settings—Default of Network**

<b>Parameter</b>	<b>Factory Default Setting</b>
IP Addressing	DHCP
IP Address <sup>a</sup>	10.10.10.10
Web Access Username	admin
Web Access Password	admin
Subnet Mask <sup>a</sup>	255.0.0.0
Default Gateway <sup>a</sup>	10.0.0.1

a. Default if there is not a DHCP server present.

---

## 2.2.1 Connect Power to the Speaker

Figure 2-2 through Figure 2-4 illustrates how to connect power to the Singlewire InformaCast Talk-Back Speaker.

### 2.2.1.1 Singlewire InformaCast Talk-Back Speaker to a 802.3af Compliant PoE Switch

Figure 2-2 illustrates how to connect the Singlewire InformaCast Talk-Back Speaker to a 802.3af compliant PoE switch via a Cat 5 Ethernet cable.

**Figure 2-2. Singlewire InformaCast Talk-Back Speaker to a 802.3af Compliant PoE Switch**

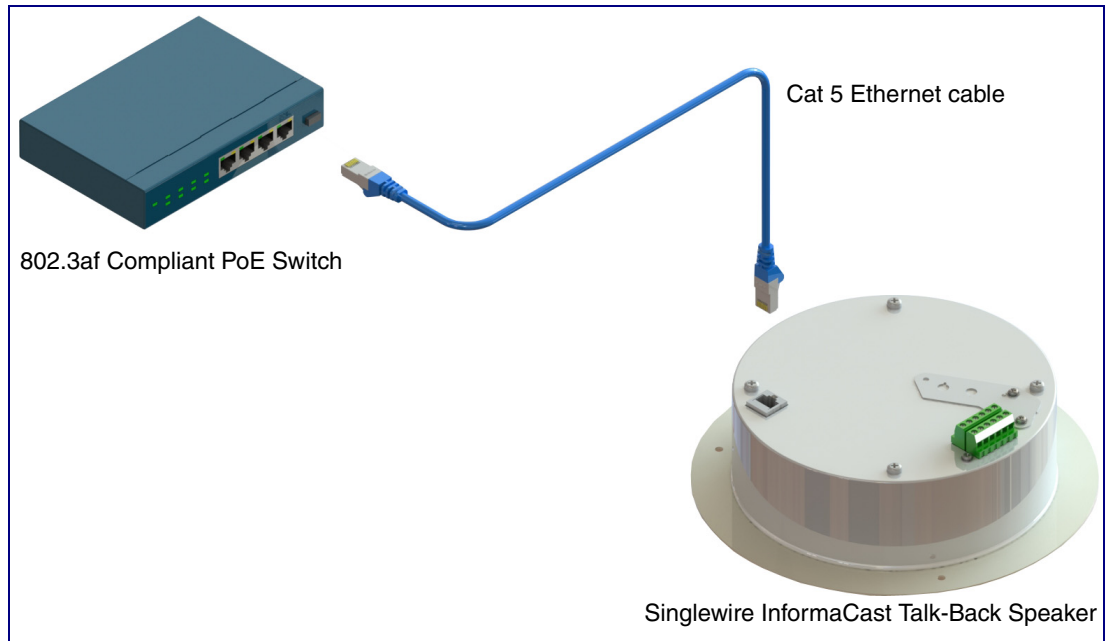

### 2.2.1.2 Singlewire InformaCast Talk-Back Speaker (with PoE Injector) to a 802.3af Compliant PoE Switch

In [Figure 2-3](#), if a PoE switch is not available, you will need a PoE Injector, part #010867A (ordered separately). A PoE Injector is a power supply solution for those who have a standard Non PoE Switch.

**Figure 2-3. Singlewire InformaCast Talk-Back Speaker (with PoE Injector) to a Non PoE Switch**

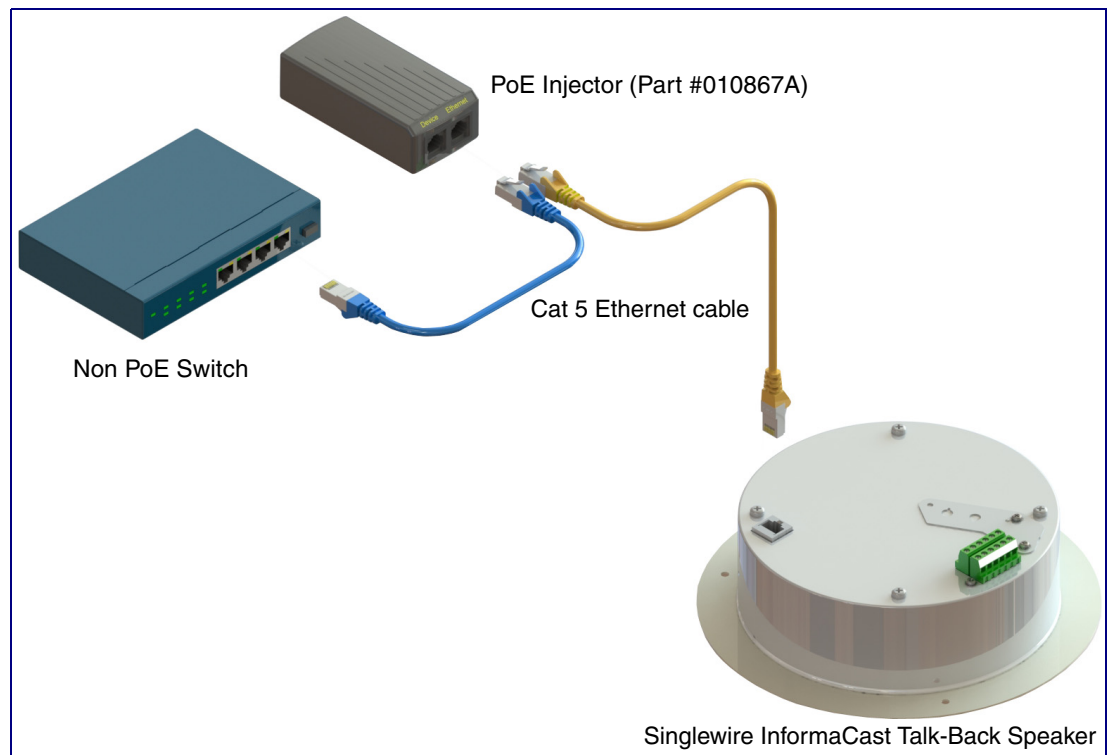

### 2.2.1.3 Running the Singlewire InformaCast Talk-Back Speaker with Auxiliary Power

In [Figure 2-4](#), the power for the Singlewire InformaCast Talk-Back Speaker can either come from an 802.3af Network connection or from an external source.

 GENERAL ALERT	<p><b>Caution</b></p> <p><i>Operational Note:</i> Do not connect an auxiliary power supply when the Singlewire InformaCast Talk-Back Speaker is connected to a PoE power source through J1. Improper operation or equipment damage may occur.</p>
--	---

**Figure 2-4. Running the Speaker with Auxiliary Power**

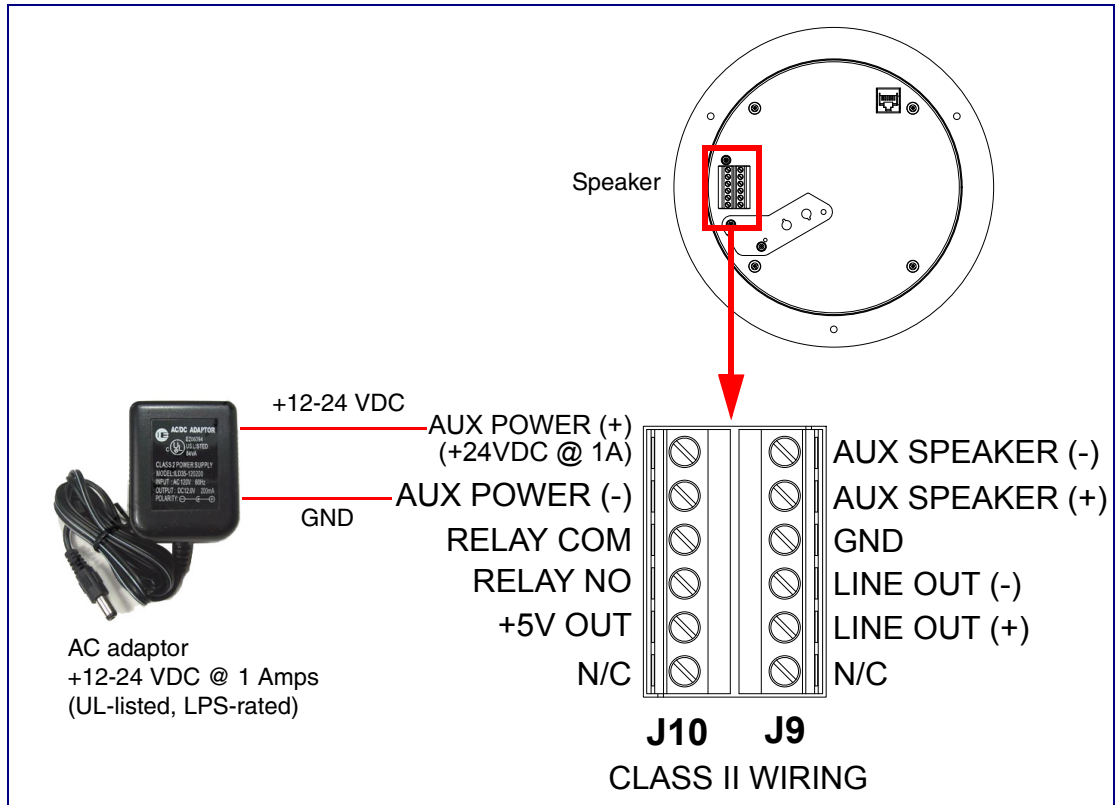



## 2.2.2 Installation Options

This section shows various installation options for the Singlewire InformaCast Talk-Back Speaker.

### 2.2.2.1 Running the Singlewire InformaCast Talk-Back Speaker with a Remote Call Button

**Note** Figure 2-4 shows the optional 011185 Remote Call Button (sold separately). See Section 1.8.1, "Optional 011185 Remote Call Button (sold separately)"

In Figure 2-4, the optional Remote Call Button (sold separately) enables calls to the Singlewire InformaCast Talk-Back Speaker that can be initiated or answered from a remotely-mounted switch. When enabled through the web interface, if the Remote Call Button is pressed, the speaker would initiate a SIP call to a predetermined extension.

When the Singlewire InformaCast Talk-Back Speaker is called from a remote phone and Auto-Answer is not enabled within the unit's Web interface, the LED on the Remote Button will blink. The call will be answered when the button is pressed.

**Figure 2-5. Running the Speaker with a Remote Call Button**

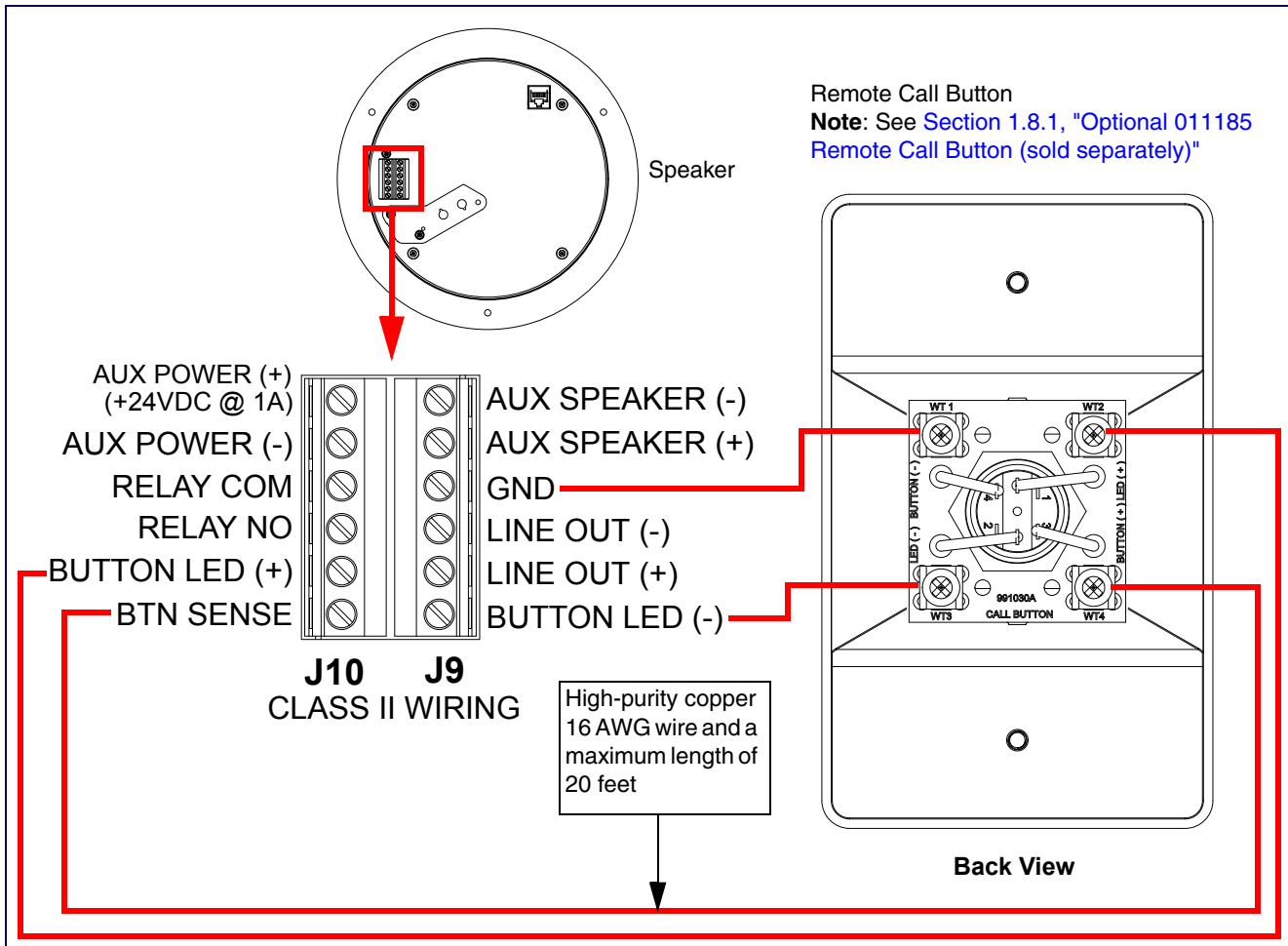

### 2.2.2.2 Singlewire InformaCast Talk-Back Speaker with an External Device

In [Figure 2-6](#), when the Singlewire InformaCast Talk-Back Speaker is called from a remote phone, the relay on the speaker can be programmed to drive an external device such as an alert strobe. This external device may also be addressed from a separate Unified Communication (UC) server.

**Figure 2-6. Speaker with an External Device**

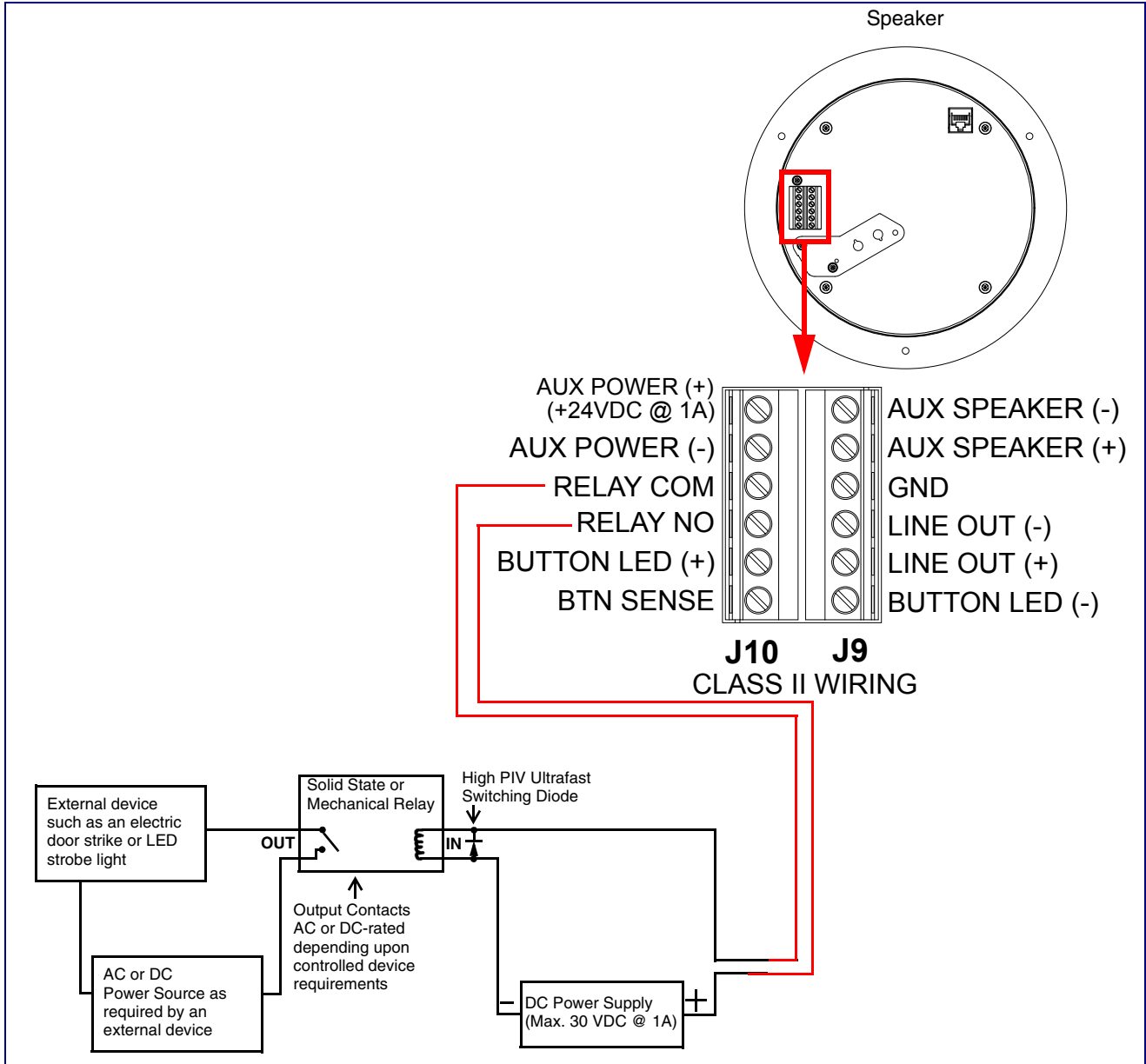

### 2.2.2.3 Singlewire InformaCast Talk-Back Speaker with Auxiliary Speaker Connection

In [Figure 2-7](#), the Singlewire InformaCast Talk-Back Speaker supports an amplified audio output for a second analog speaker. While the total speaker wattage is the same, by connecting a low cost analog speaker, additional coverage can be realized

 <small>GENERAL ALERT</small>	<p><b>Caution</b></p> <p><i>Operational Note:</i> The SIP speaker dynamically adjusts volume to properly budget power when accessories are connected. For best performance, it is recommended that either an 802.3AT or 24V auxiliary power source is used when connecting an auxiliary speaker and a clock kit.</p>
---	--

**Figure 2-7. Singlewire InformaCast Talk-Back Speaker with Auxiliary Speaker Connection**

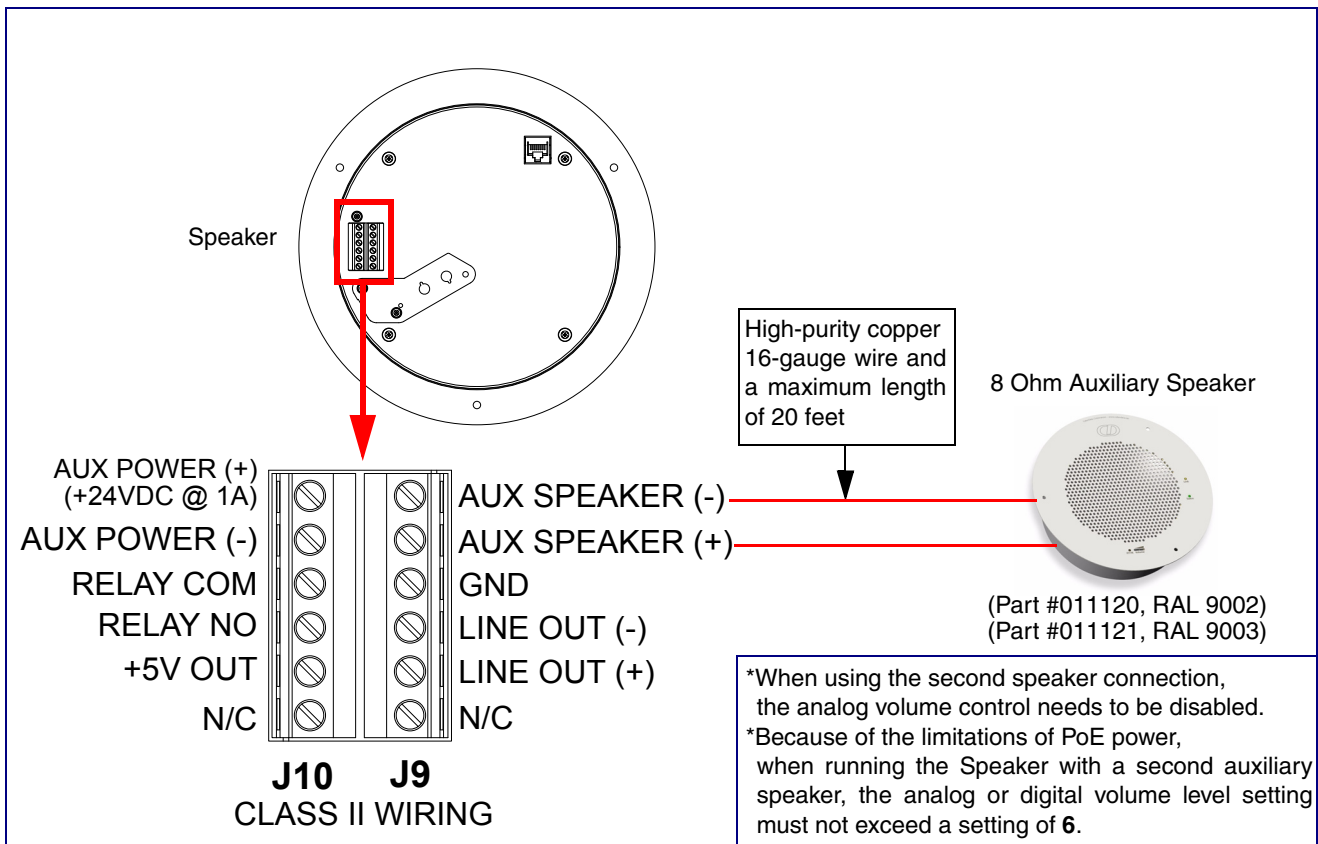

### 2.2.2.4 Singlewire InformaCast Talk-Back Speaker with Line Out

In [Figure 2-8](#), for areas that require more speaker volume, the Singlewire InformaCast Talk-Back Speaker can be connected directly to an auxiliary amplifier to drive additional horns or speakers. This is done through the line-out connection.

**Figure 2-8. Singlewire InformaCast Talk-Back Speaker with Line Out**

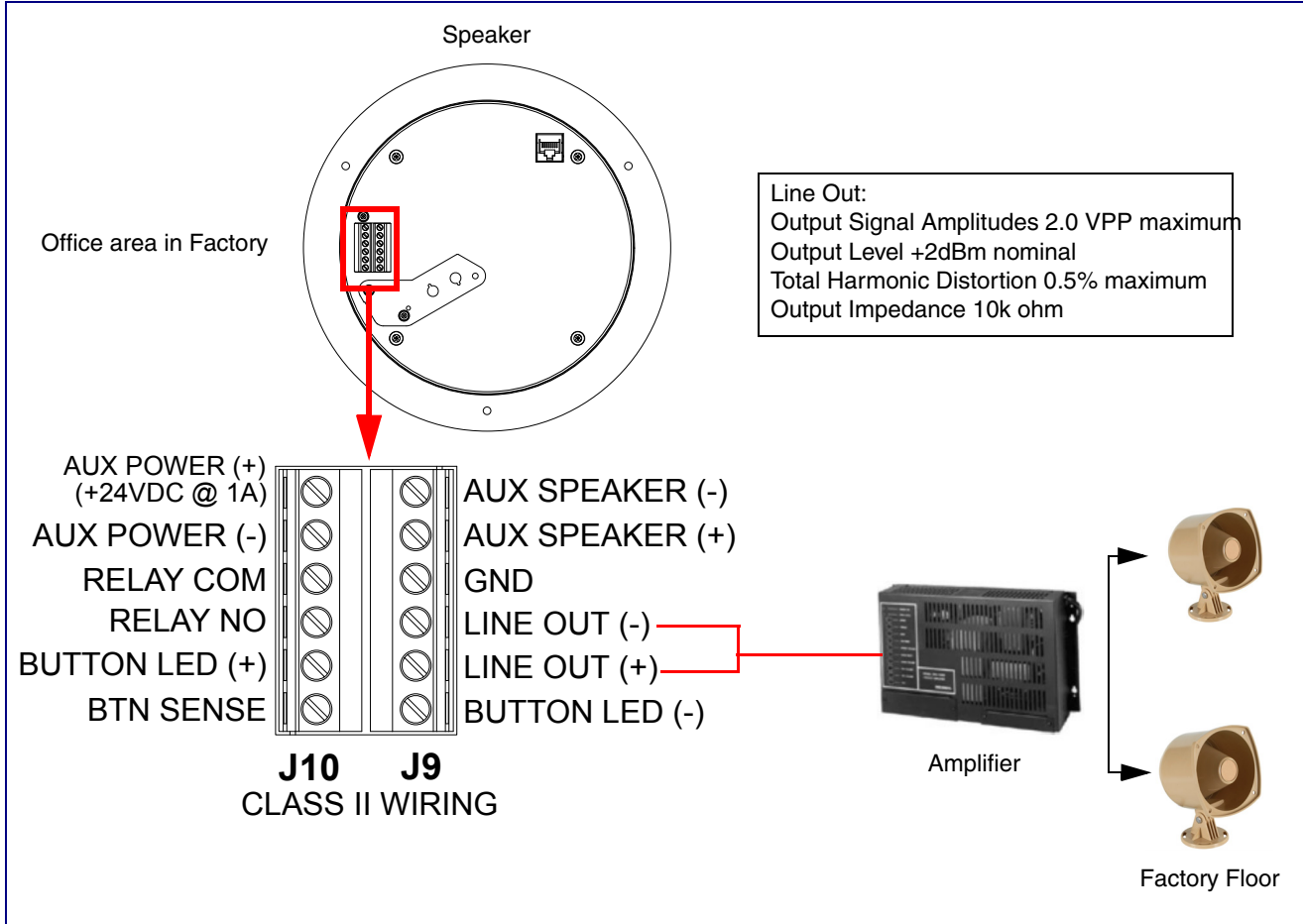

## 2.2.3 Confirm that the Speaker is Operational and Linked to the Network

After connecting the speaker to the 802.3af compliant Ethernet hub, the LEDs on the speaker face confirm that the speaker is operational and linked to the network.

**Figure 2-9. Status and Activity LEDs**

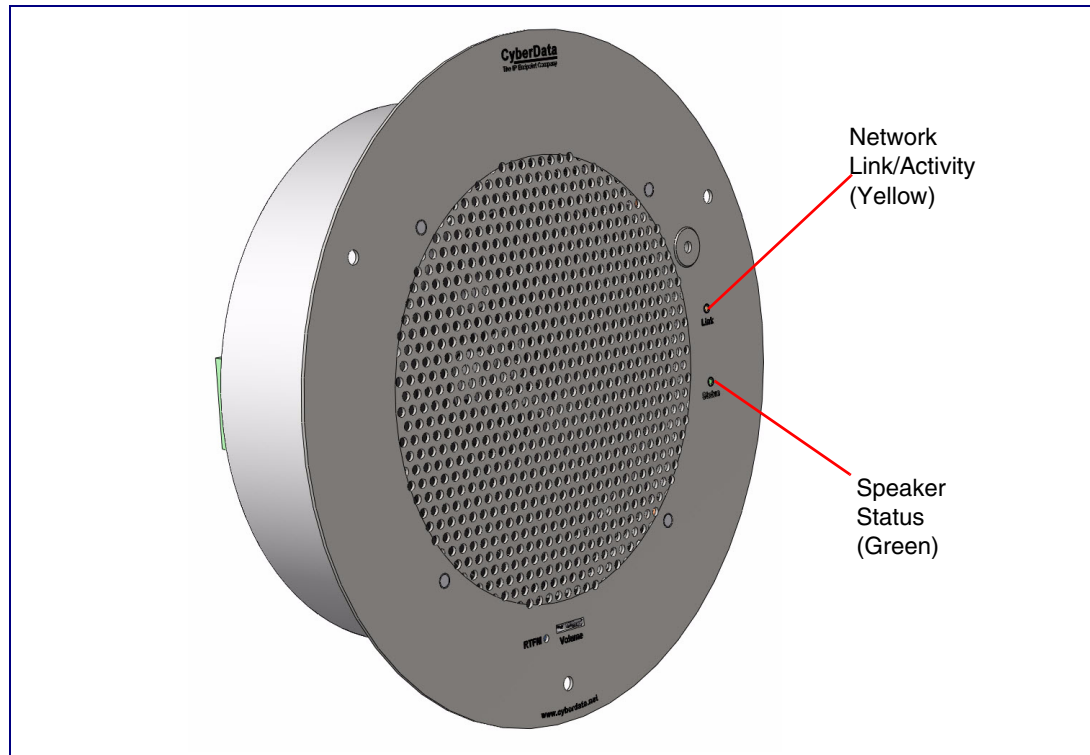

### 2.2.3.1 Status LED

After supplying power to the speaker:

1. The green power/status LED and the yellow network LED comes on immediately.
2. After about 23 seconds with a static IP address (or 27 seconds if the board is set to use DHCP), the green LED will blink twice to indicate that the board is fully booted. The speaker will beep at this time if the **Beep on Init** option is enabled on the **Device Configuration Page** (see [Section 2.3.5, "Configure the Device"](#)).

**Note** If the board is set to use DHCP and there is not a DHCP server available on the network, it will try 12 times with a three second delay between tries and eventually fall back to the programmed static IP address (by default 10.10.10.10). This process will take approximately 80 seconds.

**Note** The front power/status LED will remain solid on during operation.

### 2.2.3.2 Link LED

- The **Link** LED is illuminated when the network link to the speaker is established.
- The **Link** LED blinks to indicate network traffic.

## 2.2.4 Confirm the IP Address and Test the Audio

### 2.2.4.1 Reset Test Function Management (RTFM) Button

When the speaker is operational and linked to the network, use the Reset Test Function Management (RTFM) button (Figure 2-10) on the speaker face to announce and confirm the speaker's IP Address and test that the audio is working.

**Note** Using the RTFM button will lock the digital volume level to 4 and disable the analog volume control dial.

Figure 2-10. RTFM Button

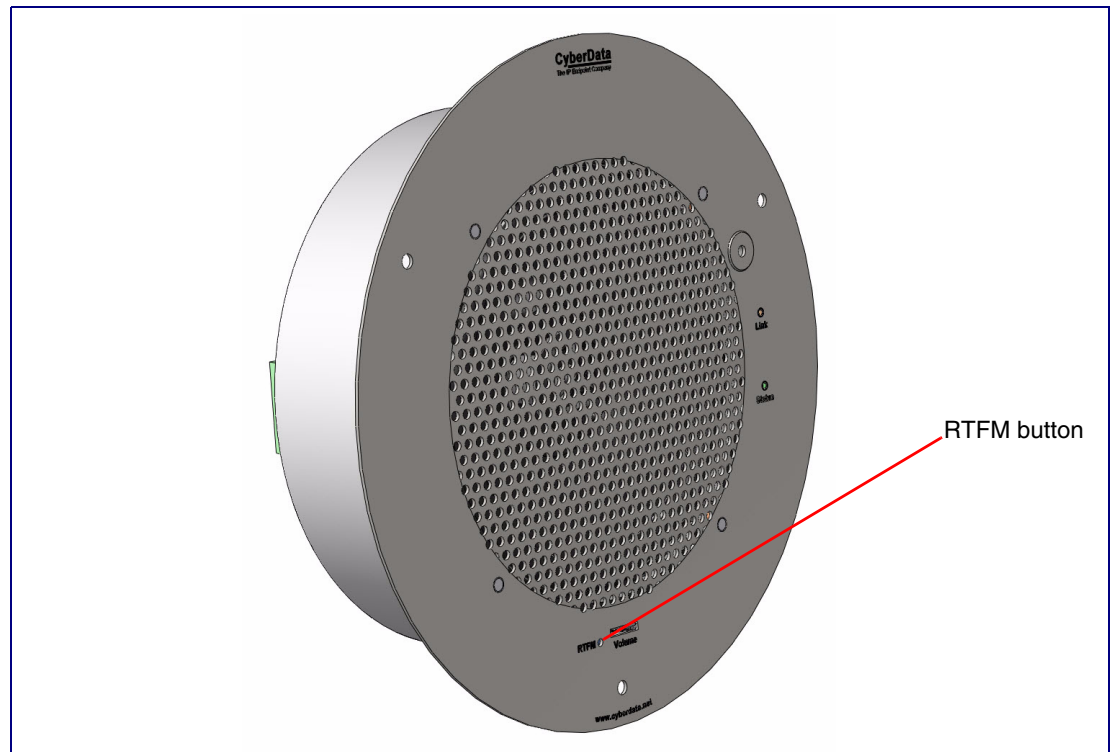

To announce a speaker's current IP address, press and release the RTFM button within a five second window.

**Note** The speaker will use DHCP to obtain the new IP address (DHCP-assigned address or default to 10.10.10.10 if a DHCP server is not present).

**Note** Pressing and holding the RTFM button for longer than five seconds will restore the speaker to the factory default settings.

---

## 2.2.5 Adjust the Volume

To adjust the speaker volume, turn the **Volume** control dial (Figure 2-11) on the speaker face.

**Note** The Singlewire InformaCast Talk-Back Speaker has two volume controls: **Internal** (web-based) and **External** (volume knob). The external volume control can be disabled from the web interface by selecting **Disable Volume Control Dial** on the **Device Configuration Page** (see Section 2.3.5, "Configure the Device").

**Figure 2-11. Volume Control**

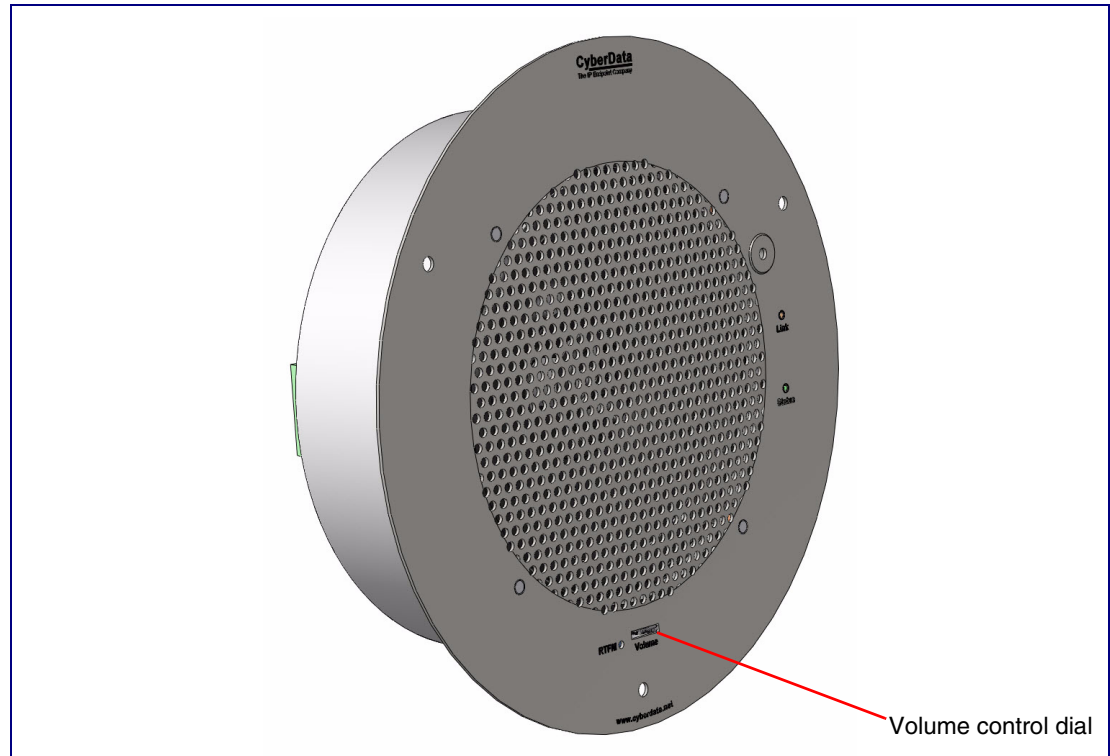

---

## 2.2.6 How to Set the Factory Default Settings

### 2.2.6.1 RTFM Button

When the speaker is operational and linked to the network, use the Reset Test Function Management (RTFM) button (Figure 2-12) on the speaker face to set the factory default settings.

**Figure 2-12. RTFM Button**

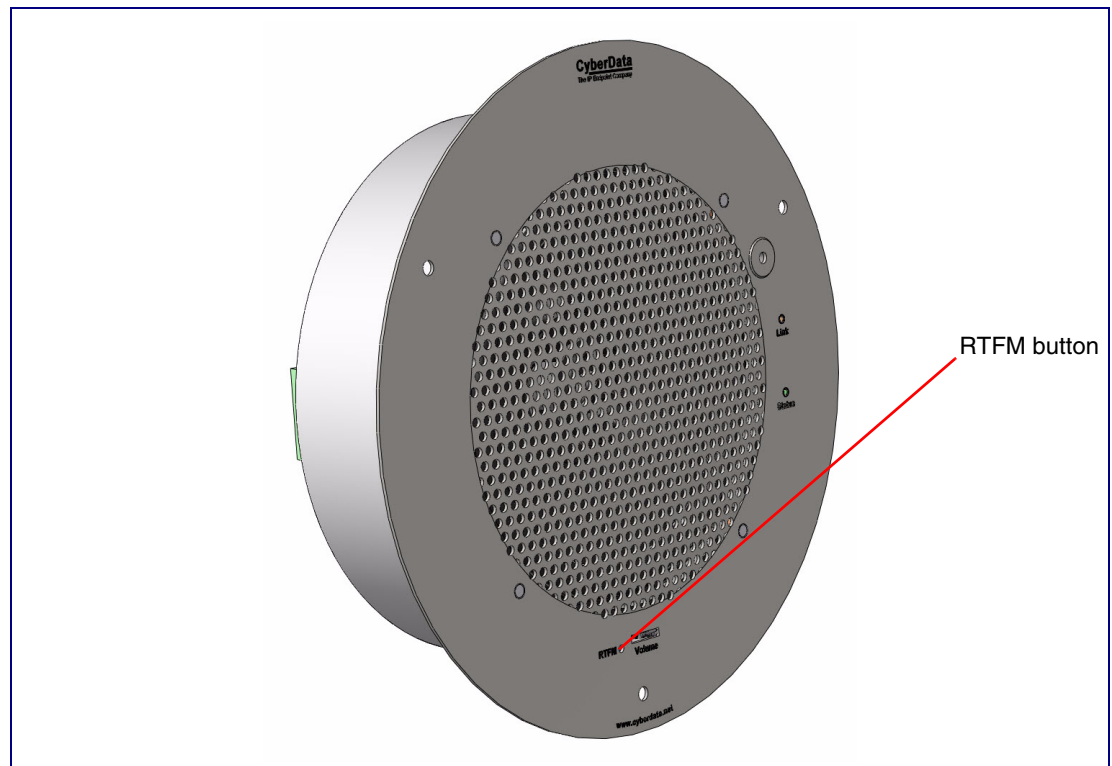

To set the factory default settings:

1. Press and hold the **RTFM** button for more than five seconds.
2. The speaker announces that it is restoring the factory default settings.

**Note** The speaker will use DHCP to obtain the new IP address (DHCP-assigned address or default to 10.10.10.10 if a DHCP server is not present).



---

## 2.3 Configure the Singlewire InformaCast Talk-Back Speaker Parameters

To configure the Singlewire InformaCast Talk-Back Speaker online, use a standard web browser.

Configure each Singlewire InformaCast Talk-Back Speaker and verify its operation *before* you mount it. When you are ready to mount an Singlewire InformaCast Talk-Back Speaker, refer to [Appendix A, "Mounting the Intercom"](#) for instructions.

---

### 2.3.1 Factory Default Settings

All Singlewire InformaCast Talk-Back Speakers are initially configured with the following default IP settings:

When configuring more than one Singlewire InformaCast Talk-Back Speaker, attach the Singlewire InformaCast Talk-Back Speakers to the network and configure one at a time to avoid IP address conflicts.

**Table 2-4. Factory Default Settings**







<b>Parameter</b>	<b>Factory Default Setting</b>
IP Addressing	DHCP
IP Address <sup>a</sup>	10.10.10.10
Web Access Username	admin
Web Access Password	admin
Subnet Mask <sup>a</sup>	255.0.0.0
Default Gateway <sup>a</sup>	10.0.0.1

a. Default if there is not a DHCP server present.

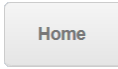
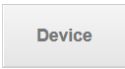
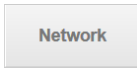
## 2.3.2 Singlewire InformaCast Talk-Back Speaker Web Page Navigation

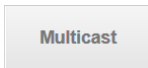
Table 2-5 shows the navigation buttons that you will see on every Singlewire InformaCast Talk-Back Speaker web page.

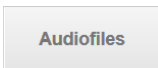
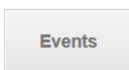
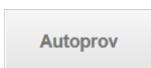
**Table 2-5. Web Page Navigation**

Web Page Item	Description
	Link to the <b>Home</b> page.
	Link to the <b>Device</b> page.
	Link to the <b>Network</b> page.
	Link to go to the <b>SIP</b> page.
	Link to the <b>Multicast</b> page.
	Link to the <b>Sensor</b> page.
	Link to the <b>Audiofiles</b> page.
	Link to the <b>Events</b> page.
	Link to the <b>Autoprovisioning</b> page.
	Link to the <b>Firmware</b> page.

### 2.3.3 Using the Toggle Help Button

The **Toggle Help** button allows you to see a short description of some of the settings on the webpage. To use the **Toggle Help** button, do the following:

1. Click on the **Toggle Help** button that is on the UI webpage. See [Figure 2-13](#) and [Figure 2-14](#).

**Figure 2-13. Toggle/Help Button**



2. You will see a question mark ( ? ) appear next to each web page item that has been provided with a short description by the Help feature. See [Figure 2-14](#).

**Figure 2-14. Toggle Help Button and Question Marks**

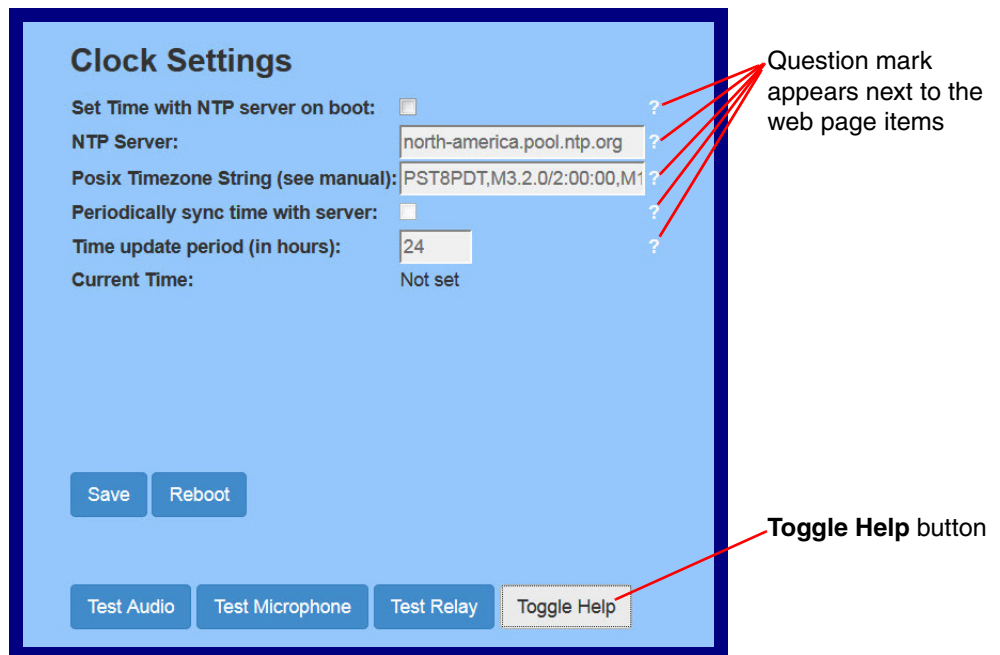

3. Move the mouse pointer to hover over the question mark (?), and a short description of the web page item will appear. See [Figure 2-15](#).

**Figure 2-15. Short Description Provided by the Help Feature**

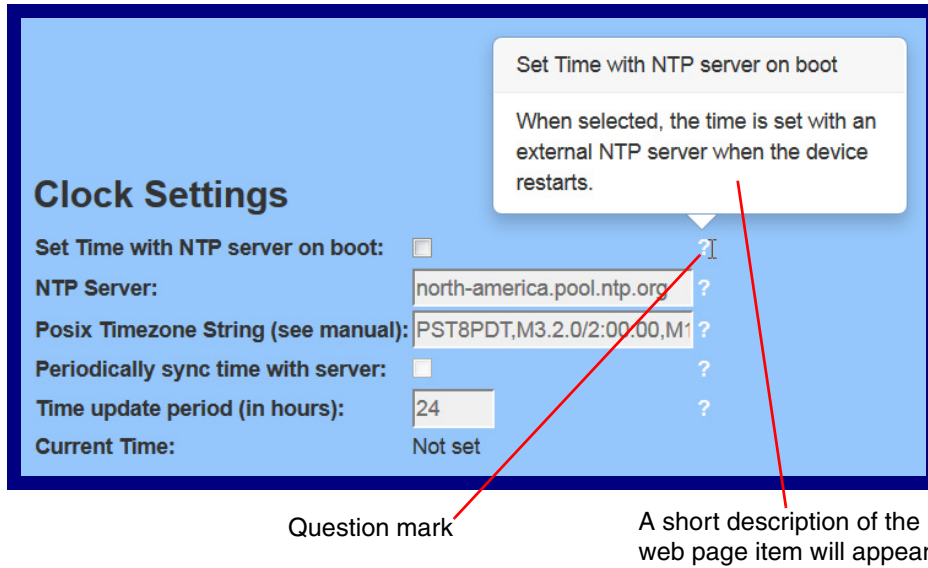

---

## 2.3.4 Log in to the Configuration Home Page

1. Open your browser to the Singlewire InformaCast Talk-Back Speaker IP address.

**Note** If the network does not have access to a DHCP server, the device will default to an IP address of 10.10.10.10.

**Note** Make sure that the PC is on the same IP network as the Singlewire InformaCast Talk-Back Speaker.

**Note** You may also download CyberData's VoIP Discovery Utility program which allows you to easily find and configure the default web address of the CyberData VoIP products.

CyberData's VoIP Discovery Utility program is available at the following website address:

<http://www.cyberdata.net/assets/common/discovery.zip>

**Note** The device ships in DHCP mode. To get to the **Home** page, use the discovery utility to scan for the device on the network and open your browser from there.

2. When prompted, use the following default **Web Access Username** and **Web Access Password** to access the **Home Page** (Figure 2-16):

Web Access Username: **admin**

Web Access Password: **admin**

Figure 2-16. Home Page

Home Device Network SIP Multicast Sensor Audiofiles Events Autopro Firmware

# Singlewire V3.1 Speaker

### Current Status

Serial Number: 399100001  
Mac Address: 00:20:f7:03:69:5f  
Firmware Version: v11.6.6

IP Addressing: DHCP  
IP Address: 10.10.1.190  
Subnet Mask: 255.0.0.0  
Default Gateway: 10.0.0.1  
DNS Server 1: 10.0.1.56  
DNS Server 2:

SIP Mode: Enabled  
Multicast Mode: Disabled  
Event Reporting: Disabled  
Nightringer: Disabled

Primary SIP Server: **Not registered**  
Backup Server 1: Not registered  
Backup Server 2: Not registered  
Nightringer Server: Not registered  
Monitor SIP Server: **Not registered**

### Admin Settings

Username:   
Password:   
Confirm Password:

### Import Settings

No file chosen

### Export Settings

### Singlewire Status

Boot Time: 2016/09/21 09:30:58  
Current Time: 2016/09/21 09:52:30  
IC Servers: 10.0.1.195  
10.0.1.196  
Configuration File: InformaCastSpeaker.cfg  
B'casts Accepted: 0  
B'casts Rejected: 0  
B'casts Active: 0

3. On the **Home** page, review the setup details and navigation buttons described in [Table 2-6](#).







**Note** The question mark icon (?) in the following table shows which web page items will be defined after the **Toggle Help** button is pressed.

**Table 2-6. Home Page Overview**

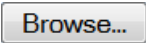
Web Page Item	Description
<b>Admin Settings</b>	
Username ?	The username to access the web interface. Enter up to 25 characters.
Password ?	The password to access the web interface. Enter up to 25 characters.
Confirm Password ?	Confirm the web interface password.
<b>Current Status</b>	
Serial Number	Shows the device serial number.
Mac Address	Shows the device Mac address.
Firmware Version	Shows the current firmware version.
IP Addressing	Shows the current IP addressing setting ( <b>DHCP</b> or <b>static</b> ).
IP Address	Shows the current IP address.
Subnet Mask	Shows the current subnet mask address.
Default Gateway	Shows the current default gateway address.
DNS Server 1	Shows the current DNS Server 1 address.
DNS Server 2	Shows the current DNS Server 2 address.
SIP Mode	Shows the current status of the SIP mode.
Multicast Mode	Shows the current status of the Multicast mode.
Event Reporting	Shows the current status of the Event Reporting mode.
Nightringer	Shows the current status of the Nightringer mode.
Monitor SIP Server	Shows the current status of the Monitor SIP Server.
Primary SIP Server	Shows the current status of the Primary SIP Server.
Backup Server 1	Shows the current status of Backup Server 1.
Backup Server 2	Shows the current status of Backup Server 2.
Nightringer Server	Shows the current status of Nightringer Server.



**Table 2-6. Home Page Overview (continued)**

Web Page Item	Description
<b>Singlewire Settings</b>	
Boot Time	Shows the boot time.
Current Time	Shows the current time.
IC Servers	Shows the InformaCast server IP addresses.
Configuration File	Shows the configuration file.
B'casts Accepted	Shows the number of B'casts accepted.
B'casts Rejected	Shows the number of B'casts rejected.
B'casts Active	Shows the number of active B'casts.
<b>Import Settings</b>	
	Use the <b>Browse</b> button to select a configuration file to import. <b>Note:</b> The name of this button may be different and will depend on the web browser that you are using.
	After selecting a configuration file, click Import to import the configuration from the selected file. Then, click Save and Reboot to store changes.
<b>Export Settings</b>	
	Click Export to export the current configuration to a file.
	Click the <b>Save</b> button to save your configuration settings. <b>Note:</b> You need to reboot for changes to take effect.
	Click on the <b>Reboot</b> button to reboot the system.
	Click on the <b>Toggle Help</b> button to see a short description of some of the web page items. First click on the <b>Toggle Help</b> button, and you will see a question mark (?) appear next to some of the web page items. Move the mouse pointer to hover over a question mark to see a short description of a specific web page item.

## 2.3.5 Configure the Device

1. Click the **Device** menu button to open the **Device** page. See [Figure 2-17](#).

Figure 2-17. Device Configuration Page

Home Device Network SIP Multicast Sensor Audiofiles Events Autoprovisioning Firmware

# Singlewire V3.1 Speaker

### Volume Settings (0-9)

Disable Volume Control Dial:

SIP Volume: 4

Multicast Volume: 4

Ring Volume: 4

Sensor Volume: 4

Push to Talk Volume: 4

Volume Boost: No Volume Boost

### Microphone Settings (0-9)

Microphone: Installed

Microphone Gain: 4

Push to Talk Microphone Gain: 4

Microphone Boost 1 (+20dB):

Microphone Boost 2 (+20dB):

### DTMF Settings

Require Security Code:

Security Code:

Enable DTMF Push to Talk:

Monitor DTMF Toggle Key: #

### Power Settings

802.3AT Mode:  Not detected. Disabled

Force 802.3AT Mode (NOT recommended):

Auxiliary Power Supply:

### NTP Settings

Set Time with NTP server on boot:

NTP Server: north-america.pool.ntp.org

Posix Timezone String (see manual): PST8PDT,M3.2.0/2:00:00,M11.:

Periodically sync time with server:

Time update period (in hours): 24

Current Time: Not set

### Relay Settings

Activate Relay with DTMF code:

Relay Pulse Code: 123

Relay Pulse Duration (in seconds): 2

Relay Activation Code: 456

Relay Deactivation Code: 654

Activate Relay During Ring:

Activate Relay During Night Ring:

Activate Relay While Call Active:

Figure 2-18. Device Configuration Page

### Clock Settings

Clock Kit:  Not Installed  Installed

Clock Brightness (0-14):

Use Ambient Light Sensor:

Clock Colon Type:  Off  On  Blink

Use 24 Hour time:

### Misc Settings

Device Name:

Auto-Answer Incoming Calls:

Beep on Init:

Beep on Page:

Disable HTTPS (NOT recommended):

Dual Speakers:

RGB Strobe:  Installed

### Button Settings

Button Installed:

Activate Relay On Button Press:

Relay On Button Press Duration:

Button Lit when Idle:

Button Brightness (0-255):

Play Ringback Tone:

Prevent Call Termination:

Blink button LED on monitor call:

### Singlewire Broadcast Strobe Settings

Priority	Scene	Color	Brightness	Red	Green	Blue	
1	ADA	Red	<input type="text" value="100"/>	<input type="text" value="255"/>	<input type="text" value="0"/>	<input type="text" value="0"/>	<a href="#">Preview</a>
2	ADA	Green	<input type="text" value="100"/>	<input type="text" value="0"/>	<input type="text" value="255"/>	<input type="text" value="0"/>	<a href="#">Preview</a>
3	ADA	Blue	<input type="text" value="100"/>	<input type="text" value="0"/>	<input type="text" value="0"/>	<input type="text" value="255"/>	<a href="#">Preview</a>
4	ADA	Yellow	<input type="text" value="100"/>	<input type="text" value="255"/>	<input type="text" value="255"/>	<input type="text" value="0"/>	<a href="#">Preview</a>
5	ADA	Violet	<input type="text" value="100"/>	<input type="text" value="255"/>	<input type="text" value="0"/>	<input type="text" value="255"/>	<a href="#">Preview</a>
6	ADA	Cyan	<input type="text" value="100"/>	<input type="text" value="0"/>	<input type="text" value="255"/>	<input type="text" value="255"/>	<a href="#">Preview</a>
7	ADA	Red	<input type="text" value="100"/>	<input type="text" value="255"/>	<input type="text" value="0"/>	<input type="text" value="0"/>	<a href="#">Preview</a>
8	ADA	Green	<input type="text" value="100"/>	<input type="text" value="0"/>	<input type="text" value="255"/>	<input type="text" value="0"/>	<a href="#">Preview</a>
9	ADA	Blue	<input type="text" value="100"/>	<input type="text" value="0"/>	<input type="text" value="0"/>	<input type="text" value="255"/>	<a href="#">Preview</a>
10	ADA	Custom	<input type="text" value="100"/>	<input type="text" value="100"/>	<input type="text" value="100"/>	<input type="text" value="100"/>	<a href="#">Preview</a>

2. On the **Device** page, you may enter values for the parameters indicated in [Table 2-7](#).

**Note** The question mark icon (?) in the following table shows which web page items will be defined after the **Toggle Help** button is pressed.

**Table 2-7. Device Configuration Parameters**

Web Page Item	Description
<b>Volume Settings (0-9)</b>	
Disable Volume Control Dial ?	Select this option to disable the volume control dial and enable digital volume control settings.
SIP Volume ?	Set the speaker volume for a SIP call. A value of 0 will mute the speaker during SIP calls.
Multicast Volume ?	Set the speaker volume for multicast audio streams. A value of 0 will mute the speaker during multicasts.
Ring Volume ?	Set the ring volume for incoming calls. A value of 0 will mute the speaker instead of playing the ring tone when Auto-Answer Incoming Calls is disabled.
Sensor Volume ?	Set the speaker volume for playing sensor activated audio. A value of 0 will mute the speaker during sensor activated audio.
Push To Talk Volume ?	Set the speaker volume for Push to Talk operation. A value of 0 will mute the speaker in Push to Talk mode.
Volume Boost: ? No Volume Boost +4dB	Set the Boost level to increase the volume output of the speaker. Using Volume Boost may introduce audio clipping and/or distortion. Boost is only recommended for use with volumes set to level 9.
<b>DTMF Settings</b>	
Require Security Code ?	When selected, the user will be prompted to enter a Security Code (entered on this page) before being able to execute a page when calling the device.
Security Code ?	Type the Security Code in this field. The Security Code must only use characters '0-9', '*' and '#'. Enter up to 25 characters.
Monitor DTMF Toggle Key ?	Specify the key that toggles between monitor mode's 'talk' and 'listen' states. Defaults to '#'.  <b>Note:</b> Some PBX's use # for other call functions.
<b>NTP Settings</b>	
Set Time with NTP Server on boot ?	When selected, the time is set with an external NTP server when the device restarts.
NTP Server ?	Use this field to set the address (in IPv4 dotted decimal notation or as a canonical name) for the NTP Server. This field can accept canonical names of up to 64 characters in length.
Posix Timezone String ?	See <a href="#">Section 2.3.5.1, "Time Zone Strings"</a> for information about how to use the Posix Timezone String to specify time zone and daylight savings time where applicable. Enter up to 63 characters.
Periodically sync time with server ?	When selected, the time is periodically updated with the NTP server at the configured interval below.
Time update period (in hours) ?	The time interval after which the device will contact the NTP server to update the time. Enter up to 4 digits.

















**Table 2-7. Device Configuration Parameters (continued)**

Web Page Item	Description
Current Time <a href="#">?</a>	Allows you to input the current time. (6 character limit)
<b>Clock Settings</b>	
Clock Kit <a href="#">?</a>	Displays the status of optional Clock Kit.
Clock Brightness (0 - 14) <a href="#">?</a>	This setting allows you to select the clock brightness level (0-14).
Use Ambient Light Sensor <a href="#">?</a>	This setting enables or disables the ambient light sensor.
Clock Colon Type <a href="#">?</a>	This setting allows you to select the clock colon type.
Use 24 Hour Time <a href="#">?</a>	When selected, the time will be show in 24 hour format on the optional clock display.
<b>Button Settings</b>	
Button Installed <a href="#">?</a>	When selected, the speaker is assumed to be wired to a push-to-talk button. Button settings will be enabled and sensor settings will be disabled. When not selected, the speaker is assumed to be wired to a sensor. Sensor settings will be enabled and button settings will be disabled.
Activate Relay On Button Press <a href="#">?</a>	When selected, the relay will be activated when the Call button is pressed.
Relay On Button Press Duration <a href="#">?</a>	The length of time (in seconds) during which the relay will be activated when the Call button is pressed. Enter up to 5 digits. A Relay on Button Press Duration value of 0 will pulse the relay once when the Call button is pressed.
Button Lit when Idle <a href="#">?</a>	When selected, the Call button LED is illuminated while the device is idle (a call is not in progress).
Button Brightness (0-255) <a href="#">?</a>	The desired Call button LED brightness level. Acceptable values are 0-255, where 0 is the dimmest and 255 is the brightest. Enter up to 3 digits.
Play Ringback Tone <a href="#">?</a>	When selected, the device will play a ringback tone (corresponds to Ringback Tone on the Audiofiles page) out of the speaker while placing an outbound call. The Ringback Tone will play until the call is answered.
Prevent Call Termination <a href="#">?</a>	When this option is enabled, a call cannot be terminated using the call button.
Blink button LED on monitor call <a href="#">?</a>	Selecting this will cause the button LED blink during a monitor call. Unselecting this will cause the speaker to give no indication that it is in a monitor call.
<b>Singlewire Broadcast Strobe Settings</b>	
Priority <a href="#">?</a>	Indicates the priority of the Singlewire broadcast, with 1 the highest priority and 10 the lowest.
Scene <a href="#">?</a>	Use this section to select the strobe flashing behavior for the Singlewire Broadcast.
ADA Compliant <a href="#">?</a>	Strobe will blink ON at the specified brightness for 150ms then OFF for 350ms during the duration of the event.



**Table 2-7. Device Configuration Parameters (continued)**

Web Page Item	Description
Slow Fade <a href="#">?</a>	Strobe will increase in brightness from 0 to the specified brightness and back to 0 over the course of about 3.5 seconds during the duration of the event.
Fast Fade <a href="#">?</a>	Strobe will increase in brightness from 0 to the specified brightness and back to 0 over the course of about 1.5 seconds during the duration of the event.
Slow Blink <a href="#">?</a>	Strobe will blink ON at the specified brightness for one second then OFF for one second during the duration of the event.
Fast Blink <a href="#">?</a>	Strobe will blink ON at the specified brightness then OFF five times per second during the duration of the event.
Color <a href="#">?</a>	Select the desired color (only one may be chosen).
Brightness <a href="#">?</a>	How bright the strobe will blink when there is a Singlewire Broadcast. This is the maximum brightness for "fade" type scenes.
Red <a href="#">?</a>	The red LED value for the Singlewire Broadcast.
Green <a href="#">?</a>	The green LED value for the Singlewire Broadcast.
Blue <a href="#">?</a>	The blue LED value for the Singlewire Broadcast.
	Use this button to preview the strobe flashing behavior for the <b>Singlewire Broadcast Strobe Settings</b> .
<b>Microphone Settings</b>	
Microphone <a href="#">?</a>	Displays the status of optional microphone.
Microphone Gain <a href="#">?</a>	Set the microphone gain level.
Push to Talk Microphone Gain <a href="#">?</a>	Set the microphone gain level for Push to Talk operation.
Microphone Boost 1 (+20dB) <a href="#">?</a>	Enables one of two +20dB gain boosts on the microphone when checked.
Microphone Boost 2 (+20dB) <a href="#">?</a>	Enables one of two +20dB gain boosts on the microphone when checked.
<b>Power Settings</b>	
802.3AT Mode <a href="#">?</a>	This device automatically detects if it is plugged into an 802.3AT (also known as PoE Plus) power source. 802.3AT provides more power than older 802.3AT power sources and allows this speaker to play audio at higher volumes. If you are sure this speaker is connected to an 802.3AT power source, but it is not being detected correctly, you can override the automatic settings below.
Force 802.3AT Mode (NOT recommended) <a href="#">?</a>	Enable this option if you are sure this speaker is connected to an 802.3AT power source, but it is not being detected correctly (not recommended).
Auxiliary Power Supply <a href="#">?</a>	This device can be connected to a +24VDC auxiliary power supply. Check this box if this is how this speaker is being powered.
<b>Relay Settings</b>	
Activate Relay with DTMF Code <a href="#">?</a>	Activates the relay when the DTMF Activation Code is entered on the phone during a SIP call with the device. RFC2833 DTMF payload types are supported.

**Table 2-7. Device Configuration Parameters (continued)**

Web Page Item	Description
Relay Pulse Code 	DTMF code used to pulse the relay when entered on a phone during a SIP call with the device. Relay will activate for Relay Pulse Duration seconds then deactivate. Activate Relay with DTMF Code must be enabled. Enter up to 25 digits (* and # are supported).
Relay Pulse Duration (in seconds) 	The length of time (in seconds) during which the relay will be activated when the DTMF Relay Activation Code is detected. Enter up to 5 digits.
Relay Activation Code 	Activation code used to activate the relay when entered on a phone during a SIP call with the device. Relay will be active indefinitely, or until the DTMF Relay Deactivation code is entered. Activate Relay with DTMF Code must be enabled. Enter up to 25 digits (* and # are supported).
Relay Deactivation Code 	Code used to deactivate the relay when entered on a phone during a SIP call with the device. Activate Relay with DTMF Code must be enabled. Enter up to 25 digits (* and # are supported).
Activate Relay During Ring 	When selected, the relay will be activated for as long as the device is ringing. When Auto-Answer Incoming Calls is enabled, the device will not ring and this option does nothing.
Activate Relay During Night Ring 	When selected, the relay will be activated as long as the Nightringer extension is ringing.
Activate Relay While Call Active 	When selected, the relay will be activated as long as the SIP call is active.
<b>Misc Settings</b>	
Device Name 	Type the device name. Enter up to 25 characters.
Auto-Answer Incoming Calls 	When selected, the device will automatically answer incoming calls. When Auto-Answer Incoming Calls is disabled, the device will play a ring tone (corresponds to Ring Tone on the Audiofiles page) out of the speaker until someone presses the Call button to answer the call or the caller disconnects before the call can be answered.
Beep on Init 	Device will play the user-defined “pagetone” audio file when it boots.
Beep on Page 	Device will play the user defined “pagetone” audio file before playing a SIP page.
Disable HTTPS (NOT recommended) 	Disables the encrypted connection to the webpage. We do not recommend disabling HTTPS for security reasons.
Dual Speakers 	Select this option if two speakers (main and auxiliary) are connected to the board.
RGB Strobe 	Status of optional RGB Strobe.
	Click on the <b>Test Audio</b> button to do an audio test. When the <b>Test Audio</b> button is pressed, you will hear a voice message for testing the device audio quality and volume.
	Click on the <b>Test Microphone</b> button to do a microphone test. When the <b>Test Microphone</b> button is pressed, the following occurs: <ol style="list-style-type: none"> <li>1. The device will immediately start recording 3 seconds of audio.</li> <li>2. The device will beep (indicating the end of recording).</li> <li>3. The device will play back the recorded audio.</li> </ol>

**Table 2-7. Device Configuration Parameters (continued)**

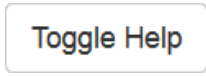
Web Page Item	Description
	Click on the <b>Test Relay</b> button to do a relay test.
	Click the <b>Save</b> button to save your configuration settings. <b>Note:</b> You need to reboot for changes to take effect.
	Click on the <b>Reboot</b> button to reboot the system.
	Click on the <b>Toggle Help</b> button to see a short description of some of the web page items. First click on the <b>Toggle Help</b> button, and you will see a question mark (?) appear next to some of the web page items. Move the mouse pointer to hover over a question mark to see a short description of a specific web page item.

**Note** You can change the **SIP Volume**, **Multicast Volume**, **Ring Volume**, **Sensor Volume**, and **Push To Talk Volume** without rebooting the device. You must save and reboot the device for other changes to take effect.



## 2.3.5.1 Time Zone Strings

The posix time zone string tells the internal date and time utilities how to handle daylight savings time for different time zones. [Table 2-20](#) shows some common strings.

**Table 2-8. Common Time Zone Strings**

Time Zone	Time Zone String
US Pacific time	PST8PDT,M3.2.0/2:00:00,M11.1.0/2:00:00
US Mountain time	MST7MDT,M3.2.0/2:00:00,M11.1.0/2:00:00
US Eastern Time	EST5EDT,M3.2.0/2:00:00,M11.1.0/2:00:00
Phoenix Arizona <sup>a</sup>	MST7
US Central Time	CST6DST,M3.2.0/2:00:00,M11.1.0/2:00:00

a. Phoenix, Arizona does not use daylight savings time.

[Table 2-21](#) shows a breakdown of the parts that constitute the following time zone string:

- ***CST6DST,M3.2.0/2:00:00,M11.1.0/2:00:00***

**Table 2-9. Time Zone String Parts**

Time Zone String Part	Meaning
CST6CDT	The time zone offset from GMT and three character identifiers for the time zone.
CST	Central Standard Time
6	The (hour) offset from GMT/UTC
CDT	Central Daylight Time
M3.2.0/2:00:00	The date and time when daylight savings begins.
M3	The third month (March)
.2	The 2nd occurrence of the day (next item) in the month
.0	Sunday
/2:00:00	Time of day to change
M11.1.0/2:00:00	The date and time when daylight savings ends.
M11	The eleventh month (November)
.1	The 1st occurrence of the day (next item) in the month
.0	Sunday
/2:00:00	Time of day to change

Time Zone String Examples [Table 2-22](#) has some more examples of time zone strings.

**Table 2-10. Time Zone String Examples**

Time Zone	Time Zone String
Tokyo <sup>a</sup>	IST-9
Berlin <sup>b</sup>	CET-1MET,M3.5.0/1:00,M10.5.0/1:00

- a. Tokyo does not use daylight savings time.
- b. For Berlin, daylight savings time starts on the last Sunday in March at 01:00 UTC, and ends on the last Sunday in October at 01:00 UTC, and is one hour ahead of UTC.

Time Zone Identifier A user-definable three or four character time zone identifier (such as PST, EDT, IST, MUT, etc) is needed at the beginning of the posix time zone string to properly set the time. However, the specific letters or numbers used for the time zone identifier are not important and can be any three or four letter or number combination that is chosen by the user. However, the time zone identifier cannot be blank.

**Figure 2-19. Three or Four Character Time Zone Identifier**

You can also use the following URL when a certain time zone applies daylight savings time:

<http://www.timeanddate.com/time/dst/2011.html>

World GMT Table [Table 2-23](#) has information about the GMT time in various time zones.

**Table 2-11. World GMT Table**

Time Zone	City or Area Zone Crosses
GMT-12	Eniwetok
GMT-11	Samoa
GMT-10	Hawaii
GMT-9	Alaska
GMT-8	PST, Pacific US
GMT-7	MST, Mountain US
GMT-6	CST, Central US
GMT-5	EST, Eastern US
GMT-4	Atlantic, Canada
GMT-3	Brazilia, Buenos Aries
GMT-2	Mid-Atlantic
GMT-1	Cape Verdes
GMT	Greenwich Mean Time, Dublin
GMT+1	Berlin, Rome
GMT+2	Israel, Cairo
GMT+3	Moscow, Kuwait
GMT+4	Abu Dhabi, Muscat

**Table 2-11. World GMT Table (continued)**

<b>Time Zone</b>	<b>City or Area Zone Crosses</b>
GMT+5	Islamabad, Karachi
GMT+6	Almaty, Dhaka
GMT+7	Bangkok, Jakarta
GMT+8	Hong Kong, Beijing
GMT+9	Tokyo, Osaka
GMT+10	Sydney, Melbourne, Guam
GMT+11	Magadan, Soloman Is.
GMT+12	Fiji, Wellington, Auckland

## 2.3.6 Configure the Network Parameters

1. Click the **Network** menu button to open the **Network** page (Figure 2-20).

Figure 2-20. Network Configuration Page

Home Device **Network** SIP Multicast Sensor Audiofiles Events Autoprov Firmware

# Singlewire V3.1 Speaker

### Stored Network Settings

Addressing Mode:  Static  DHCP

Hostname: SipDevice812aa6

IP Address: 10.10.10.10

Subnet Mask: 255.0.0.0

Default Gateway: 10.0.0.1

DNS Server 1: 10.0.0.1

DNS Server 2: 10.0.0.1

DHCP Timeout in seconds\*: 60

\* A value of -1 will retry forever

### VLAN Settings

VLAN ID (0-4095): 0

VLAN Priority (0-7): 0

Save Reboot Toggle Help

### Current Network Settings

IP Address: 10.10.0.225

Subnet Mask: 255.0.0.0

Default Gateway: 10.0.0.1

DNS Server 1: 10.0.1.56

DNS Server 2:



2. On the **Network** page, enter values for the parameters indicated in [Table 2-12](#).

**Note** The question mark icon (?) in the following table shows which web page items will be defined after the **Toggle Help** button is pressed.

**Table 2-12. Network Configuration Parameters**

Web Page Item	Description
<b>Stored Network Settings</b>	
Addressing Mode ?	Select either DHCP IP Addressing or Static Addressing by marking the appropriate radio button. DHCP Addressing mode is enabled on default and the device will attempt to resolve network addressing with the local DHCP server upon boot. If DHCP Addressing fails, the device will revert to the last known IP address or the factory default address if no prior DHCP lease was established. See <a href="#">Section 2.2.6, "How to Set the Factory Default Settings"</a> for factory default settings. Be sure to click <b>Save</b> and <b>Reboot</b> to store changes when configuring a Static address.
Hostname ?	This is the hostname provided by the DHCP server. See the DHCP/DNS server documentation for more information. Enter up to 64 characters.
IP Address ?	Enter the Static IPv4 network address in dotted decimal notation.
Subnet Mask ?	Enter the Subnet Mask in dotted decimal notation.
Default Gateway ?	Enter the Default Gateway IPv4 address in dotted decimal notation.
DNS Server 1 ?	Enter the primary DNS Server IPv4 address in dotted decimal notation.
DNS Server 2 ?	Enter the secondary DNS Server IPv4 address in dotted decimal notation.
DHCP Timeout in seconds ?	Specify the desired time-out duration (in seconds) that the device will wait for a response from the DHCP server before reverting back to the stored static IP address. The stored static IP address may be the last known IP address or the factory default address if no prior DHCP lease was established. Enter up to 8 characters. A value of -1 will retry forever.
<b>Current Network Settings</b>	
IP Address	Shows the current Static IP address.
Subnet Mask	Shows the current Subnet Mask address.
Default Gateway	Shows the current Default Gateway address.
DNS Server 1	Shows the current DNS Server 1 address.
DNS Server 2	Shows the current DNS Server 2 address.
<b>VLAN Settings</b>	
VLAN ID (0-4095) ?	Specify the IEEE 802.1Q VLAN ID number. Enter up to 4 digits.  <b>Note:</b> The device supports 802.1Q VLAN tagging support. The switch port connected to the device will need to be in "trunking mode" for the VLAN tags to propagate.
VLAN Priority (0-7) ?	Specify the IEEE 802.1p VLAN priority level. Enter 1 digit. A value of 0 may cause the VLAN ID tag to be ignored.

**Table 2-12. Network Configuration Parameters (continued)**

Web Page Item	Description
	Click the <b>Save</b> button to save your configuration settings. <b>Note:</b> You need to reboot for changes to take effect.
	Click on the <b>Reboot</b> button to reboot the system.
	Click on the <b>Toggle Help</b> button to see a short description of some of the web page items. First click on the <b>Toggle Help</b> button, and you will see a question mark (?) appear next to some of the web page items. Move the mouse pointer to hover over a question mark to see a short description of a specific web page item.

**Note** You must click on the **Save** button and then the **Reboot** button for the changes to take effect.

## 2.3.7 Configure the SIP (Session Initiation Protocol) Parameters

1. Click on the **SIP** menu button to open the **SIP** page (Figure 2-21).

Figure 2-21. SIP Configuration Page

**SIP Settings**

Enable SIP operation:

Register with a SIP Server:

Use Cisco SRST:

Primary SIP Server: 10.0.0.253

Primary SIP User ID: 199

Primary SIP Auth ID: 199

Primary SIP Auth Password: \*\*\*\*\*

Backup SIP Server 1:

Backup SIP User ID 1:

Backup SIP Auth ID 1:

Backup SIP Auth Password 1:

Backup SIP Server 2:

Backup SIP User ID 2:

Backup SIP Auth ID 2:

Backup SIP Auth Password 2:

Remote SIP Port: 5060

Local SIP Port: 5060

Outbound Proxy:

Outbound Proxy Port: 0

Monitor User ID: 200

Monitor Authenticate ID: 200

Monitor Authenticate Password: \*\*\*\*\*

Disable rport Discovery:

Buffer SIP Calls:

Re-registration Interval (in seconds): 360

Unregister on Boot:

Keep Alive Period: 10000

**Nightringer Settings**

Enable Nightringer:

SIP Server: 10.0.0.253

Remote SIP Port: 5060

Local SIP Port: 5061

Outbound Proxy:

Outbound Proxy Port: 0

User ID: 241

Authenticate ID: 241

Authenticate Password: \*\*\*\*\*

Re-registration interval (in seconds): 360

**Nightringer Strobe Settings**

Blink Strobe on Nightring:

Nightringer Strobe Brightness: 100

ADA Compliant

Slow Fade

Fast Fade

Slow Blink

Fast Blink

Color: Blue

Red: 0

Green: 0

Blue: 255

Preview

**RTP Settings**

RTP Port (even): 10500

Jitter Buffer: 50

Figure 2-22. SIP Configuration Page

The screenshot displays a configuration interface for SIP parameters, organized into five main sections:

- SIP Strobe Settings:** Includes a checkbox for "Blink Strobe on Ring" (unchecked), a "SIP Call Strobe Brightness" field set to 100, radio buttons for "ADA Compliant", "Slow Fade", "Fast Fade", "Slow Blink", and "Fast Blink" (all unselected), a "SIP Call Color" dropdown menu set to "Green", and input fields for "Red" (0), "Green" (255), and "Blue" (0). A "Preview" button is located below these settings.
- MWI Strobe Settings:** Includes a checkbox for "Blink Strobe on MWI" (unchecked), an "MWI Strobe Brightness" field set to 100, radio buttons for "ADA Compliant", "Slow Fade", "Fast Fade", "Slow Blink", and "Fast Blink" (all unselected), an "MWI Color" dropdown menu set to "Yellow", and input fields for "Red" (255), "Green" (255), and "Blue" (0). A "Preview" button is located below these settings.
- Call Disconnection:** Features a "Terminate Call after delay:" field set to 0.
- Codec Selection:** Includes a "Force Selected Codec:" checkbox (unchecked) and a "Codec:" dropdown menu set to "PCMU (G.711, u-law)".
- Button Settings:** Includes a "Dial Out Extension:" field set to 204 and an "Extension ID:" field set to id204.

At the bottom of the page, there are three buttons: "Save", "Reboot", and "Toggle Help".



2. On the **SIP** page, enter values for the parameters indicated in [Table 2-13](#).

**Note** The question mark icon (?) in the following table shows which web page items will be defined after the **Toggle Help** button is pressed.

**Table 2-13. SIP Configuration Parameters**

Web Page Item	Description
<b>SIP Settings</b>	
Enable SIP Operation ?	When enabled, the device will transmit, receive, and process SIP messages according to the configured SIP settings below.
Register with a SIP Server ?	When enabled, the device will attempt to register to the configured SIP Server(s) on this page. To configure the device to send and receive point-to-point SIP calls, enable <b>SIP Operation</b> and disable <b>Register with a SIP Server</b> (see <a href="#">Section 2.3.7.2, "Point-to-Point Configuration"</a> ).
Use Cisco SRST ?	When enabled, the backup servers are handled according to Cisco SRST (Survivable Remote Site Telephony). It is required for use in clustered Cisco Unified Communications Manager topologies.
Primary SIP Server ?	Enter the SIP server address as an IPv4 address in dotted decimal notation or a fully qualified domain name. This parameter also becomes the host portion of the SIP-URI for the device's extension on the primary SIP server. This field can accept entries of up to 255 characters in length.
Primary SIP User ID ?	Specify the SIP User ID for the Primary SIP Server. This parameter becomes the user portion of the SIP-URI for the device's extension on the primary SIP server. Enter up to 64 alphanumeric characters.
Primary SIP Auth ID ?	Specify the Authenticate ID for the Primary SIP Server. This parameter is required for SIP registration authentication. Enter up to 64 alphanumeric characters.
Primary SIP Auth Password ?	Specify the Authenticate Password for the Primary SIP Server. This parameter is required for SIP registration authentication. Enter up to 64 alphanumeric characters.
Backup SIP Server 1 ?	Enter the backup SIP server address as an IPv4 address in dotted decimal notation or a fully qualified domain name. This parameter also becomes the host portion of the SIP-URI for the device's extension on the backup SIP server. This field can accept entries of up to 255 characters in length.
Backup SIP User ID 1 ?	Specify the SIP User ID for the first backup SIP Server. This parameter becomes the user portion of the SIP-URI for the device's extension on the first backup SIP server. Enter up to 64 alphanumeric characters.
Backup SIP Auth ID 1 ?	Specify the Authenticate ID for the first backup SIP server. This parameter is required for SIP registration authentication. Enter up to 64 alphanumeric characters.
Backup SIP Auth Password 1 ?	Specify the Authenticate Password for the first backup SIP server. This parameter is required for SIP registration authentication. Enter up to 64 alphanumeric characters.
Backup SIP Server 2 ?	Enter a second backup SIP server address as an IPv4 address in dotted decimal notation or a fully qualified domain name. This parameter also becomes the host portion of the SIP-URI for the device's extension on the second backup SIP server. This field can accept entries of up to 255 characters in length.













**Table 2-13. SIP Configuration Parameters (continued)**

Web Page Item	Description
Backup SIP User ID 2 ?	Specify the SIP User ID for the second backup SIP Server. This parameter becomes the user portion of the SIP-URI for the device's extension on the second backup SIP server. Enter up to 64 alphanumeric characters.
Backup SIP Auth ID 2 ?	Specify the Authenticate ID for the second backup SIP server. This parameter is required for SIP registration authentication. Enter up to 64 alphanumeric characters.
Backup SIP Auth Password 2 ?	Specify the Authenticate Password for the second backup SIP server. This parameter is required for SIP registration authentication. Enter up to 64 alphanumeric characters.
Remote SIP Port ?	The Remote SIP Port is the port number the device will use as the destination port when sending SIP messages. The default Remote SIP Port is 5060. The supported range is 0-65536. Enter up to 5 digits.
Local SIP Port ?	The Local SIP Port is the port number the device will use to receive SIP messages. The default Local SIP Port is 5060. The supported range is 0-65536. Enter up to 5 digits.
Outbound Proxy ?	Enter the Outbound Proxy address as an IPv4 address in dotted decimal notation or a fully qualified domain name (FQDN). When an IP address is configured, the device will send all SIP messages to this IP address. When an FQDN is configured, the device will run DNS NAPTR, SRV, and A queries on the FQDN to resolve an IP address to which it will send all SIP messages. This field can accept entries of up to 255 characters in length.
Outbound Proxy Port ?	The Outbound Proxy Port is port number used as the destination port when sending SIP messages to the outbound proxy. A value of 0 will default to 5060. The supported range is 0-65536. Enter up to 5 digits.
Monitor User ID ?	Specify the SIP User ID for the SIP server. This parameter becomes the user portion of the SIP-URI for the device's Monitor Mode extension. Enter up to 64 alphanumeric characters.
Monitor Authenticate ID ?	Specify the Authenticate ID for the SIP Server. This parameter is required for SIP registration authentication. Enter up to 64 alphanumeric characters.
Monitor Authenticate Password ?	Specify the Authenticate Password for the SIP Server. This parameter is required for SIP registration authentication. Enter up to 64 alphanumeric characters.
Disable rport Discovery ?	Disabling rport Discovery will prevent the device from including the public WAN IP address and port number in the contact information that is sent to the remote SIP servers. This will generally only need to be enabled when using an SBC or SIP ALG in conjunction with a remote SIP server.
Buffer SIP Calls ?	Also referred to as delayed paging. Device will buffer up to 4 minutes of audio then play back the recording after hang up.
Re-registration Interval (in seconds) ?	The SIP Re-registration interval (in seconds) is the SIP Registration lease time, also known as the expiry. The supported range is 30-3600 seconds. Enter up to 4 digits.
Unregister on Boot ?	When enabled, the device will send one registration with an expiry of 0 on boot.
Keep Alive Period ?	The minimum time in milliseconds between keep-alive packets sent for nat traversal. A value of 0 will disable keep alive packets.
<b>SIP Strobe Settings</b>	



**Table 2-13. SIP Configuration Parameters (continued)**

Web Page Item	Description
Blink Strobe on Ring ?	When selected, the Strobe will blink a scene when ringing.
SIP Call Strobe Brightness ?	How bright the strobe will blink when there is a SIP Call. This is the maximum brightness for “fade” type scenes.
ADA Compliant ?	Strobe will blink ON at the specified brightness for 150ms then OFF for 350ms during the duration of the event.
Slow Fade ?	Strobe will increase in brightness from 0 to the specified brightness and back to 0 over the course of about 3.5 seconds during the duration of the event.
Fast Fade ?	Strobe will increase in brightness from 0 to the specified brightness and back to 0 over the course of about 1.5 seconds during the duration of the event.
Slow Blink ?	Strobe will blink ON at the specified brightness for one second then OFF for one second during the duration of the event.
Fast Blink ?	Strobe will blink ON at the specified brightness then OFF five times per second during the duration of the event.
SIP Call Color ?	Select desired color (only one may be chosen).
Red ?	The red LED value for SIP Call.
Green ?	The green LED value for SIP Call.
Blue ?	The blue LED value for SIP Call.
	Use this button to preview the strobe flashing behavior for the <b>MWI Strobe Settings</b> .
<b>MWI Strobe Settings</b>	
Blink Strobe on MWI ?	When selected, the strobe will blink a scene when a voicemail is waiting for its extension.
MWI Strobe Brightness ?	How bright the strobe will blink when there is a message waiting. This is the maximum brightness for “fade” type scenes.
ADA Compliant ?	Strobe will blink ON at the specified brightness for 150ms then OFF for 350ms during the duration of the event.
Slow Fade ?	Strobe will increase in brightness from 0 to the specified brightness and back to 0 over the course of about 3.5 seconds during the duration of the event.
Fast Fade ?	Strobe will increase in brightness from 0 to the specified brightness and back to 0 over the course of about 1.5 seconds during the duration of the event.
Slow Blink ?	Strobe will blink ON at the specified brightness for one second then OFF for one second during the duration of the event.
Fast Blink ?	Strobe will blink ON at the specified brightness then OFF five times per second during the duration of the event.
MWI Call Color ?	Select desired color (only one may be chosen).
Red ?	The red LED value for MWI.
Green ?	The green LED value for MWI.
Blue ?	The blue LED value for MWI.



**Table 2-13. SIP Configuration Parameters (continued)**

Web Page Item	Description
	Use this button to preview the strobe flashing behavior for the <b>MWI Strobe Settings</b> .
<b>Nightringer Settings</b>	
Enable Nightringer 	When Nightringer is enabled, the device will attempt to register a second extension with the SIP server. Any calls made to this extension will play a ringtone (corresponds to <b>Night Ring</b> on the <b>Audiofiles</b> page). By design, it is not possible to answer a call to the Nightringer extension.
SIP Server 	Enter the SIP server address as an IPv4 address in dotted decimal notation or a fully qualified domain name. This parameter also becomes the host portion of the SIP-URI for the device's Nightringer extension on the SIP server. This field can accept entries of up to 255 characters in length.
Remote SIP Port 	The Remote SIP Port is the port number the device will use as the destination port when sending SIP messages for the Nightringer extension. The default Remote SIP Port is 5060. The supported range is 0-65536. Enter up to 5 digits.
Local SIP Port 	The Local SIP Port is the port number the device will use to receive SIP messages for the Nightringer extension. This value cannot be the same as the <b>Local SIP Port</b> for the primary extension. The default Local SIP Port is 5061. The supported range is 0-65536. Enter up to 5 digits.
Outbound Proxy 	Enter the Outbound Proxy address as an IPv4 address in dotted decimal notation or a fully qualified domain name (FQDN). When an IP address is configured, the device will send all SIP messages to this IP address for the Nightringer extension. When an FQDN is configured, the device will run DNS NAPTR, SRV, and A queries on the FQDN to resolve an IP address to which it will send all SIP messages for the Nightringer extension. This field can accept entries of up to 255 characters in length.
Outbound Proxy Port 	The Outbound Proxy Port is port number used as the destination port when sending SIP messages to the outbound proxy for the Nightringer extension. A value of 0 will default to 5060. The supported range is 0-65536. Enter up to 5 digits.
User ID 	Specify the SIP User ID for the SIP server. This parameter becomes the user portion of the SIP-URI for the device's Nightringer extension. Enter up to 64 alphanumeric characters.
Authenticate ID 	Specify the Authenticate ID for the SIP Server. This parameter is required for SIP registration authentication. Enter up to 64 alphanumeric characters.
Authenticate Password 	Specify the Authenticate Password for the SIP Server. This parameter is required for SIP registration authentication. Enter up to 64 alphanumeric characters.
Re-registration Interval (in seconds) 	The SIP Re-registration Interval (in seconds) is the SIP Registration lease time, also known as the expiry. The supported range is 30-3600 seconds. Enter up to 4 digits.
<b>Nightringer Strobe Settings</b>	
Blink Strobe on Nightring 	When selected, the Strobe will blink a scene when nightringing.
Nightringer Strobe Brightness 	How bright the strobe will blink when the Nightringer is ringing. This is the maximum brightness for "fade" type scenes.

**Table 2-13. SIP Configuration Parameters (continued)**

Web Page Item	Description
ADA Compliant ?	Strobe will blink ON at the specified brightness for 150ms then OFF for 350ms during the duration of the event.
Slow Fade ?	Strobe will increase in brightness from 0 to the specified brightness and back to 0 over the course of about 3.5 seconds during the duration of the event.
Fast Fade ?	Strobe will increase in brightness from 0 to the specified brightness and back to 0 over the course of about 1.5 seconds during the duration of the event.
Slow Blink ?	Strobe will blink ON at the specified brightness for one second then OFF for one second during the duration of the event.
Fast Blink ?	Strobe will blink ON at the specified brightness then OFF five times per second during the duration of the event.
Nightringer Call Color ?	Select desired color (only one may be chosen).
Red ?	The red LED value for Nightringer.
Green ?	The green LED value for Nightringer.
Blue ?	The blue LED value for Nightringer.
	Use this button to preview the strobe flashing behavior for the <b>Nightringer Strobe Settings</b> .
<b>RTP Settings</b>	
RTP Port (even) ?	Specify the port number used for the RTP stream after establishing a SIP call. This port number must be an even number and defaults to 10500. The supported range is 0-65536. Enter up to 5 digits.
Jitter Buffer ?	Specify the size of the jitter buffer (in milliseconds) used for SIP calls. Valid values are 50-1000.
<b>Call Disconnection</b>	
Terminate Call After Delay ?	Automatically terminate an active call after a given delay in seconds. A value of 0 will disable this function. Enter up to 8 digits.
<b>Codec Selection</b>	
Force Selected Codec ?	When configured, this option will allow you to force the device to negotiate for the selected codec. Otherwise, the device will perform codec negotiation using the default list of supported codecs.
Codec ?	Select the desired codec (only one may be chosen).
<b>Button Settings</b>	
Dial Out Extension ?	Specify the extension the device will call when someone presses the Call button. Enter up to 64 alphanumeric characters.  <b>Note:</b> For information about dial-out extension strings and DTMF tones, see <a href="#">Section 2.3.7.1, "Dial Out Extension Strings and DTMF Tones (using rfc2833)"</a> .
Extension ID ?	A Caller identification string added to outbound calls. Enter up to 64 alphanumeric characters.
	Click the <b>Save</b> button to save your configuration settings.  <b>Note:</b> You need to reboot for changes to take effect.

**Table 2-13. SIP Configuration Parameters (continued)**

Web Page Item	Description
	Click on the <b>Reboot</b> button to reboot the system.
	Click on the <b>Toggle Help</b> button to see a short description of some of the web page items. First click on the <b>Toggle Help</b> button, and you will see a question mark (?) appear next to some of the web page items. Move the mouse pointer to hover over a question mark to see a short description of a specific web page item.

**Note** You must click on the **Save** button and then the **Reboot** button for the changes to take effect.

**Note** For specific server configurations, go to the following website address:  
<http://www.cyberdata.net/connecting-to-ip-pbx-servers/>

### 2.3.7.1 Dial Out Extension Strings and DTMF Tones (using rfc2833)

On the **SIP Configuration Page**, dial out extensions support the addition of comma delimited pauses and sending additional DTMF tones (using rfc2833). The first comma will pause three seconds after a call is first established with a remote device. Subsequent commas will pause for 2 seconds. A pause of one second will be sent after each numerical digit.

**Table 2-14. Examples of Dial-Out Extension Strings**

Extension String	Resulting Action
302	Dial out extension 302 and establish a call
302,2	Dial out extension 302 and establish a call, wait 3 seconds then send the DTMF tone '2'
302,25,,,4,,1	Dial out extension 302 and establish a call, wait 3 seconds then send the DTMF tone '2', send out DTMF tone 5, wait 6 seconds, send out DTMF tone 4, wait 4 seconds, send out DTMF tone 1

**Note** The maximum number of total characters in the dial-out field is 64.

### 2.3.7.2 Point-to-Point Configuration

When the device is set to not register with a SIP server (see [Figure 2-23](#)), it is possible to set the device to dial out to a single endpoint.

In this case, the dial-out extension should be the IP address of the remote device. The device can also receive Point-to-Point calls. The delayed DTMF functionality is available in the Point-to-Point Mode.

**Note** Receiving point-to-point SIP calls may not work with all phones.

**Figure 2-23. SIP Page Set to Point-to-Point Mode**

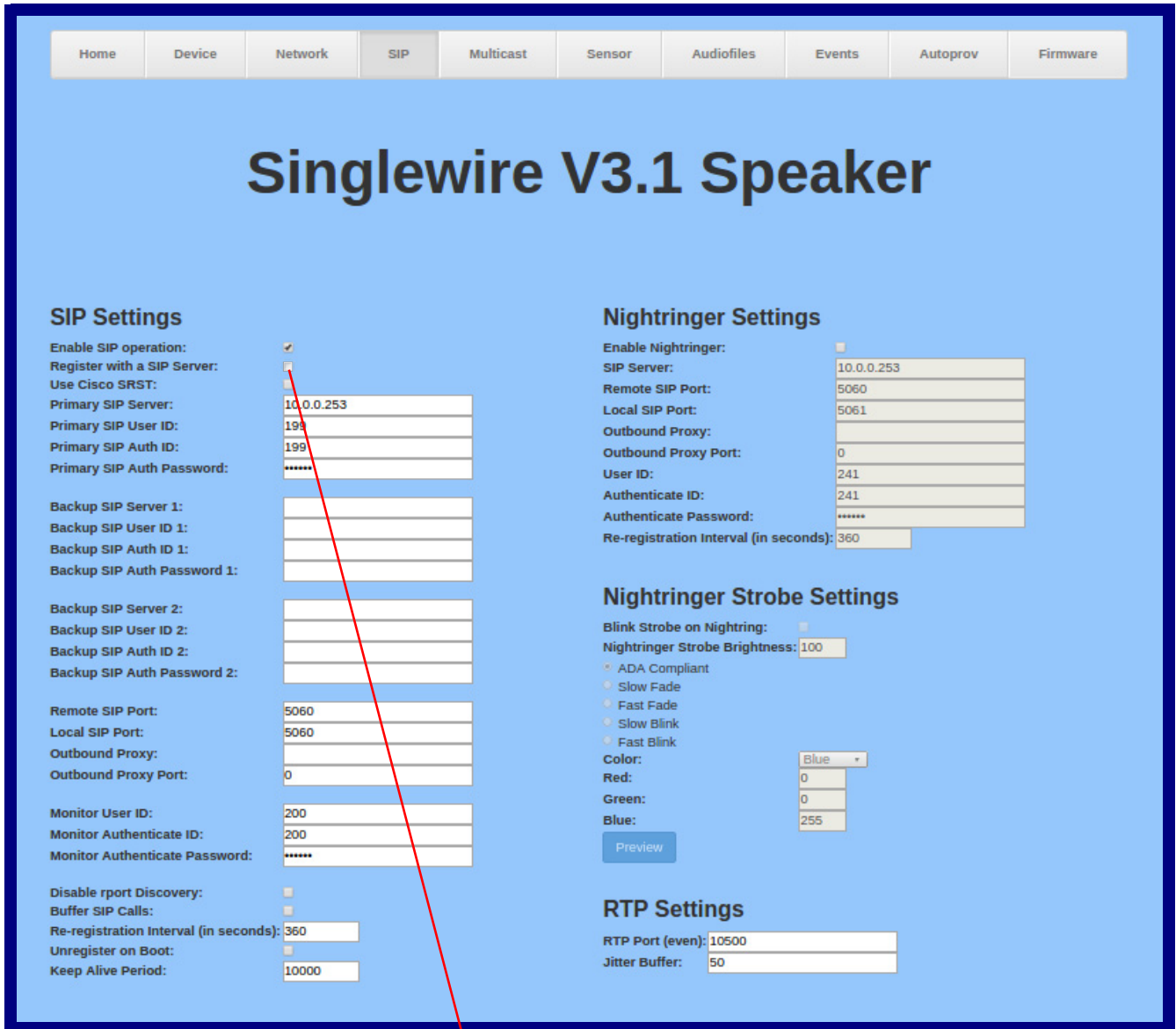

Device is set to NOT register with a SIP server

### 2.3.7.3 Delayed DTMF

On the **SIP Configuration** page the dial out extension supports the addition of comma delimited pauses and sending additional DTMF tones (using rfc2833). The first comma will pause three seconds after a call is first established with a remote device. Subsequent commas will pause for 2 seconds. A pause of one second will be sent after each numerical digit.

**Table 2-15. Examples of Dial-Out Extension Strings**

<b>Extension String</b>	<b>Resulting Action</b>
302	Dial out extension 302 and establish a call
302,2	Dial out extension 302 and establish a call, wait 3 seconds then send the DTMF tone '2'
302,25,,,4,,1	Dial out extension 302 and establish a call, wait 3 seconds then send the DTMF tone '2', send out DTMF tone 5, wait 6 seconds, send out DTMF tone 4, wait 4 seconds, send out DTMF tone 1

**Note** The maximum number of total characters in the dial-out field is 25.



---

## 2.3.8 Configure the Multicast Parameters

The Multicast Configuration page allows the device to join up to ten paging zones for receiving ulaw/alaw encoded RTP audio streams.

A paging zone can consist of one or many CyberData multicast group-enabled products. There is no limit to how many speakers can be in a given paging zone. Each multicast group is defined by a multicast address and port number.

Each multicast group is assigned a priority, allowing simultaneously arriving pages to be serviced based on importance. Multicast groups are compatible with IGMP through version 3. The device supports simultaneous SIP and Multicast.

1. Click on the **Multicast** menu button to open the **Multicast** page. See [Figure 2-24](#).

**Figure 2-24. Multicast Configuration Page**

Home Device Network SIP **Multicast** Sensor Audiofiles Events Autoprov Firmware

# Singlewire V3.1 Speaker

## Multicast Settings

Enable Multicast Operation:

Priority	Address	Port	Name	Buffer	Beep	Relay
9	239.168.3.10	11000	Emergency	<input type="checkbox"/>	<input type="checkbox"/>	<input type="checkbox"/>
8	239.168.3.9	10000	MG8	<input type="checkbox"/>	<input type="checkbox"/>	<input type="checkbox"/>
7	239.168.3.8	9000	MG7	<input type="checkbox"/>	<input type="checkbox"/>	<input type="checkbox"/>
6	239.168.3.7	8000	MG6	<input type="checkbox"/>	<input type="checkbox"/>	<input type="checkbox"/>
5	239.168.3.6	7000	MG5	<input type="checkbox"/>	<input type="checkbox"/>	<input type="checkbox"/>
4	239.168.3.5	6000	MG4	<input type="checkbox"/>	<input type="checkbox"/>	<input type="checkbox"/>
3	239.168.3.4	5000	MG3	<input type="checkbox"/>	<input type="checkbox"/>	<input type="checkbox"/>
2	239.168.3.3	4000	MG2	<input type="checkbox"/>	<input type="checkbox"/>	<input type="checkbox"/>
1	239.168.3.2	3000	MG1	<input type="checkbox"/>	<input type="checkbox"/>	<input type="checkbox"/>
0	239.168.3.1	2000	Background Music	<input type="checkbox"/>	<input type="checkbox"/>	<input type="checkbox"/>

Polycorn Default Channel

Polycorn Priority Channel

Polycorn Emergency Channel

## Multicast Strobe Settings

Blink Strobe on Multicast:

Brightness:

- ADA Compliant
- Slow Fade
- Fast Fade
- Slow Blink
- Fast Blink

Color:

Red:

Green:

Blue:

*SIP calls are considered priority 4.5*

*Port range can be from 2000-65535*

*Priority 9 is the highest and 0 is the lowest*

*A higher priority audio stream will always supersede a lower one*

*\* You need to reboot for changes to take effect*











2. On the **Multicast** page, enter values for the parameters indicated in [Table 2-16](#).

**Note** The question mark icon (?) in the following table shows which web page items will be defined after the **Toggle Help** button is pressed.

**Table 2-16. Multicast Configuration Parameters**

Web Page Item	Description
Enable Multicast Operation	Enables or disables multicast operation.
Priority	Indicates the priority for the multicast group. Priority <b>9</b> is the highest (emergency streams). <b>0</b> is the lowest (background music). SIP calls are considered priority <b>4.5</b> . See <a href="#">Section 2.3.8.1, "Assigning Priority"</a> for more details.
Address	Enter the multicast IP Address for this multicast group (15 character limit).
Port	Enter the port number for this multicast group (5 character limit [range can be from 2000 to 65535]).  <b>Note:</b> The multicast ports have to be even values. The webpage will enforce this restriction.
Name	Assign a descriptive name for this multicast group (25 character limit).
Buffer	Device will buffer up to four minutes of audio and then play back the recording after the multicast stream finishes or after the buffer is full.
Beep	When selected, the device will play a beep before multicast audio is sent.
Relay	When selected, the device will activate a relay before multicast audio is sent.
Polycom Default Channel	When a default Polycom channel/group number is selected, the device will subscribe to the default channel for one-way group pages. Group Numbers 1-25 are supported. Or, select <b>Disabled</b> to disable this channel.
Polycom Priority Channel	When a priority Polycom channel/group number is selected, the device will subscribe to the priority channel for one-way group pages. Group Numbers 1-25 are supported. Or, select <b>Disabled</b> to disable this channel.
Polycom Emergency Channel	When an emergency Polycom channel/group number is selected, the device will subscribe to the default channel for one-way group pages. Group Numbers 1-25 are supported. Or, select <b>Disabled</b> to disable this channel.
<b>Multicast Strobe Settings</b>	
Blink Strobe on Multicast ?	When selected, the Strobe will blink a scene when a multicast is received.
Multicast Strobe Brightness ?	How bright the strobe will blink on a multicast page. This is the maximum brightness for "fade" type scenes.
ADA Compliant ?	Strobe will blink ON at the specified brightness for 150ms then OFF for 350ms during the duration of the event.
Slow Fade ?	Strobe will increase in brightness from 0 to the specified brightness and back to 0 over the course of about 3.5 seconds during the duration of the event.

**Table 2-16. Multicast Configuration Parameters (continued)**

Web Page Item	Description
Fast Fade 	Strobe will increase in brightness from 0 to the specified brightness and back to 0 over the course of about 1.5 seconds during the duration of the event.
Slow Blink 	Strobe will blink ON at the specified brightness for one second then OFF for one second during the duration of the event.
Fast Blink 	Strobe will blink ON at the specified brightness then OFF five times per second during the duration of the event.
Multicast Call Color 	Select desired color (only one may be chosen).
Red 	The red LED value for Multicast.
Green 	The green LED value for Multicast.
Blue 	The blue LED value for Multicast.
	Use this button to preview the strobe flashing behavior for the <b>Multicast Strobe Settings</b> .
	Click the <b>Save</b> button to save your configuration settings. <b>Note:</b> You need to reboot for changes to take effect.
	Click on the <b>Reboot</b> button to reboot the system.

**Note** You must click on the **Save** button and then the **Reboot** button for the changes to take effect.

### 2.3.8.1 Assigning Priority

The device will prioritize simultaneous audio streams according to their priority in the list.

If both SIP and Multicast is enabled, SIP audio streams are considered priority **4.5**. SIP audio will interrupt multicast streams with priority **0** through **4** and will be interrupted by multicast streams with priority **5** through **9**.

During priority **9** multicast streams, the volume is set to maximum.

**Note** SIP calls, multicast streams, ring tones, ringback tones, and nightring tones are all prioritized.

Ringtones and Nightringtones

Ringtones all play at the same priority level. This means that it is possible to have a nightring tone and a normal ringtone playing at the same time.

---

## 2.3.9 Configure the Sensor Configuration Parameters

The door sensor (pins 5 and 6) on the header can be used to monitor a door's open or closed state. There is an option on the **Sensor** page to trigger on an open or short condition on these pins. The door sensor alarm will be activated when the **Door Open Timeout** parameter has been met.

The intrusion sensor is an optical sensor installed on the board and will be activated when the board is removed from the case.

Each sensor can trigger up to five different actions:

- Flash the LED until the sensor is deactivated (roughly 10 times/second)
- Activate the relay until the sensor is deactivated
- Loop an audio file out of the speaker until the sensor is deactivated
- Call an extension and establish two way audio
- Call an extension and play a pre-recorded audio file

**Note** Calling a preset extension can be set up as a point-to-point call, but currently can't send delayed DTMF tones.

1. Click **Sensor** menu button to open the **Sensor** page ([Figure 2-25](#)).

Figure 2-25. Sensor Configuration Page

Home Device Network SIP Multicast **Sensor** Audiofiles Events Autopro Firmware

# Singlewire V3.1 Speaker

## Sensor Settings

Sensor Normally Closed:  Yes  No

Sensor Timeout (in seconds):

Activate Relay:

Play Audio Locally:

Make call to extension:

Dial Out Extension:

Dial Out ID:

Play recorded audio:

Repeat Sensor Message:

## Sensor Strobe Settings

Blink Strobe on Sensor:

Sensor Strobe Brightness:

- ADA Compliant
- Slow Fade
- Fast Fade
- Slow Blink
- Fast Blink

Sensor Color:

Red:

Green:

Blue:











2. On the **Sensor** page, enter values for the parameters indicated in [Table 2-17](#).

**Note** The question mark icon (?) in the following table shows which web page items will be defined after the **Toggle Help** button is pressed.

**Table 2-17. Sensor Configuration Parameters**

Web Page Item	Description
<b>Sensor Settings</b>	
Sensor Normally Closed ?	Select the inactive state of the sensor. The sensor is also known as the Sense Input on the device's terminal block. See the Operations Guide for more information.
Sensor Timeout (in seconds) ?	The time (in seconds) the device will wait before it performs an action when the on-board door sensor is activated. The action(s) performed are based on the configured Sensor Settings below. Enter up to 5 digits.
Activate Relay ?	When selected, the device's on-board relay will be activated until the on-board door sensor is deactivated.
Play Audio Locally ?	When selected, the device will loop an audio file out of the speaker until the door sensor is deactivated.
Make call to extension ?	When selected, the device will call an extension when the on-board door sensor is activated. Use the <b>Dial Out Extension</b> field below to specify the extension the device will call.
Dial Out Extension ?	Specify the extension the device will call when the on-board door sensor is activated. Enter up to 64 alphanumeric characters.
Dial Out ID ?	An additional Caller identification string added to outbound calls. Enter up to 64 alphanumeric characters.
Play recorded audio ?	When selected, the device will call the <b>Dial Out Extension</b> and play an audio file to the phone answering the SIP call (corresponds to <b>Door Ajar</b> on the <b>Audiofiles</b> page).
Repeat Sensor Message ?	The number of times to repeat the audio message through the local speaker or to the remote endpoint. A value of 0 will repeat forever. Enter a value from 0-65536.
	Click the <b>Test Sensor</b> button to test the sensor.
<b>Sensor Strobe Settings</b>	
Blink Strobe on Sensor ?	When selected, the Strobe will blink a scene when the sensor is triggered.
Sensor Strobe Brightness ?	How bright the strobe will blink when the sensor is triggered. This is the maximum brightness for "fade" type scenes.
ADA Compliant ?	Strobe will blink ON at the specified brightness for 150ms then OFF for 350ms during the duration of the event.
Slow Fade ?	Strobe will increase in brightness from 0 to the specified brightness and back to 0 over the course of about 3.5 seconds during the duration of the event.
Fast Fade ?	Strobe will increase in brightness from 0 to the specified brightness and back to 0 over the course of about 1.5 seconds during the duration of the event.

**Table 2-17. Sensor Configuration Parameters (continued)**

Web Page Item	Description
Slow Blink 	Strobe will blink ON at the specified brightness for one second then OFF for one second during the duration of the event.
Fast Blink 	Strobe will blink ON at the specified brightness then OFF five times per second during the duration of the event.
Sensor Color 	Select desired color (only one may be chosen).
Red 	The red LED value for Sensor.
Green 	The green LED value for Sensor.
Blue 	The blue LED value for Sensor.
	Use this button to preview the strobe flashing behavior for the <b>Sensor Strobe Settings</b> .
	Click the <b>Save</b> button to save your configuration settings. <b>Note:</b> You need to reboot for changes to take effect.
	Click on the <b>Reboot</b> button to reboot the system.
	Click on the <b>Toggle Help</b> button to see a short description of some of the web page items. First click on the <b>Toggle Help</b> button, and you will see a question mark (  ) appear next to some of the web page items. Move the mouse pointer to hover over a question mark to see a short description of a specific web page item.

**Note** You must click on the **Save** button and then the **Reboot** button for the changes to take effect.



## 2.3.10 Configure the Audio Configuration Parameters

The **Audiofiles** page is used to add custom audio to the board. User uploaded audio will take precedence over the audio files shipped with the device.

1. Click on the **Audiofiles** menu button to open the **Audiofiles** page (Figure 2-26).

Figure 2-26. Audiofiles Configuration Page



**Figure 2-27. Audiofiles Page**







2. On the **Audiofiles** page, enter values for the parameters indicated in [Table 2-18](#).

**Note** The question mark icon (?) in the following table shows which web page items will be defined after the **Toggle Help** button is pressed.

**Table 2-18. Audiofiles Configuration Parameters**

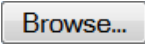
Web Page Item	Description
Available Space	Shows the space available for the user to save custom audio files if they want to change the message when the door or sensor is triggered.
0-9	<p>The name of the audio configuration option is the same as the spoken audio that plays on the board (24 character limit).</p> <p>'0' corresponds to the spoken word "zero."</p> <p>'1' corresponds to the spoken word "one."</p> <p>'2' corresponds to the spoken word "two."</p> <p>'3' corresponds to the spoken word "three."</p> <p>'4' corresponds to the spoken word "four."</p>

**Table 2-18. Audiofiles Configuration Parameters (continued)**

Web Page Item	Description
0-9	'5' corresponds to the spoken word "five." '6' corresponds to the spoken word "six." '7' corresponds to the spoken word "seven." '8' corresponds to the spoken word "eight." '9' corresponds to the spoken word "nine."
Dot	Corresponds to the spoken word "dot." (24 character limit)
Audiotest	Corresponds to the message " <b><i>This is the CyberData IP speaker test message...</i></b> " (24 character limit)
Enter Code	Corresponds to the message "Enter Code" (24 character limit).
Invalid Code	Corresponds to the message "Invalid Code" (24 character limit).
Page tone	Corresponds to a simple tone used for beep on initialization and beep on page (24 character limit).
Your IP Address is	Corresponds to the message "Your IP address is..." (24 character limit).
Rebooting	Corresponds to the spoken word "Rebooting" (24 character limit).
Restoring default	Corresponds to the message "Restoring default" (24 character limit).
Ringback tone	This is the ringback tone that plays when calling a remote extension (24 character limit).
Ring tone	This is the tone that plays when set to ring when receiving a call (24 character limit).
Sensor Triggered	Corresponds to the message "Sensor Triggered" (24 character limit).
Night Ring	Specifies the ringtone for nightring. By default this parameter uses the same audio file that is selected for the <b>Ring Tone</b> parameter.
	Click on the <b>Browse</b> button to navigate to and select an audio file. <b>Note:</b> The name of this button may be different and will depend on the web browser that you are using.
	The <b>Play</b> button will play that audio file.
	The <b>Delete</b> button will delete any user uploaded audio and restore the stock audio file.
	The <b>Save</b> button will download a new user audio file to the board once you've selected the file by using the <b>Browse</b> button. The <b>Save</b> button will delete any pre-existing user-uploaded audio files.

### 2.3.10.1 User-created Audio Files

User created audio files should be saved in the following format:

RIFF (little-endian) data, WAVE audio, Microsoft PCM, 16 bit, mono 8000 Hz

You can use the free utility *Audacity* to convert audio files into this format. See [Figure 2-28](#) through [Figure 2-30](#).

**Figure 2-28. Audacity 1**

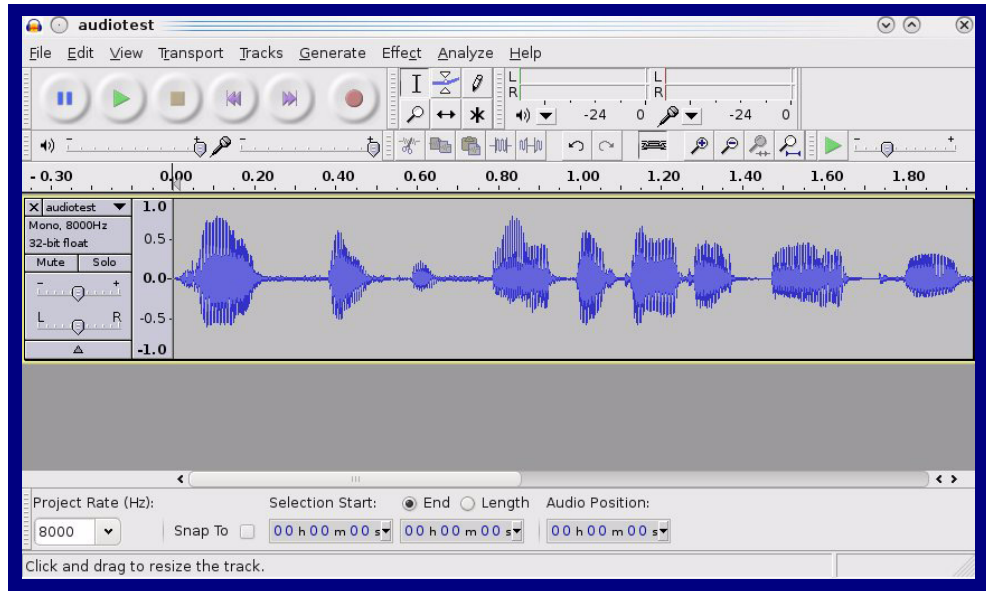

**Figure 2-29. Audacity 2**

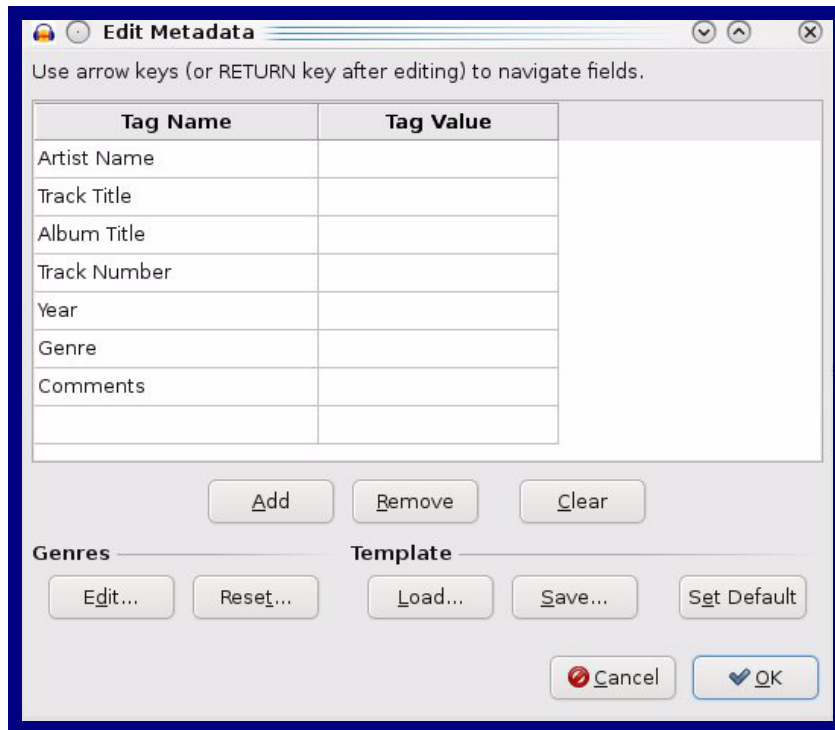

When you export an audio file with Audacity, save the output as:

- **WAV (Microsoft) signed 16 bit PCM.**

**Figure 2-30. WAV (Microsoft) signed 16 bit PCM**

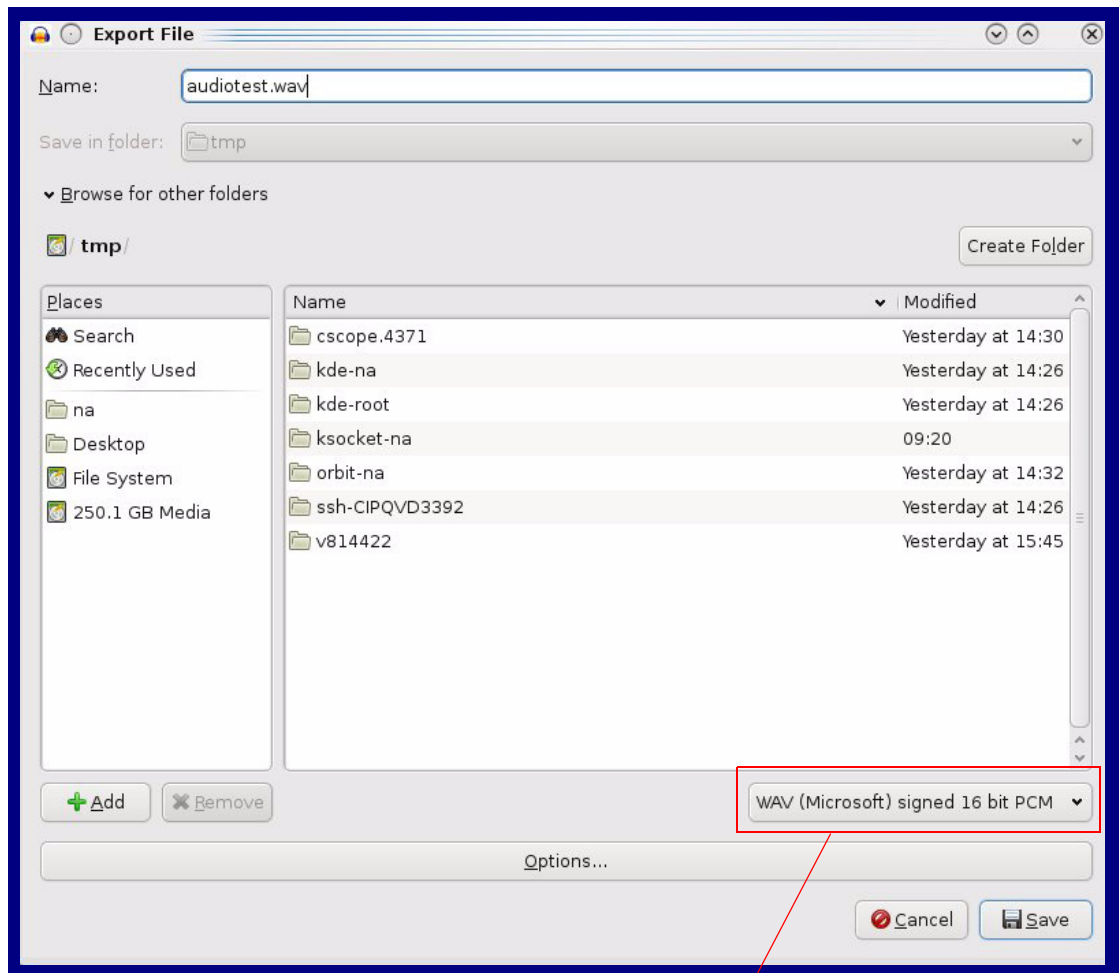

WAV (Microsoft) signed 16 bit PCM

## 2.3.11 Configure the Events Parameters

The **Events** page specifies a remote server that can be used to receive HTTP POST events when actions take place on the board.

1. Click on the **Events** menu button to open the **Events** page (Figure 2-31).

**Figure 2-31. Event Configuration Page**

Home Device Network SIP Multicast Sensor Audiofiles **Events** Autoprov Firmware

# Singlewire V3.1 Speaker

Enable Event Generation:

### Events

Enable Call Start Events:

Enable Call Terminated Events:

Enable Relay Activated Events:

Enable Relay Deactivated Events:

Enable Night Ring Events:

Enable Power On Events:

Enable Multicast Start Events:

Enable Multicast Stop Events:

Enable Sensor Events:

Enable 60 Second Heartbeat:

[Check All](#) [Uncheck All](#)

### Event Server

Server IP Address:



Server Port:

Server URL:

2. On the **Events** page, enter values for the parameters indicated in [Table 2-19](#).

**Note** The question mark icon (?) in the following table shows which web page items will be defined after the **Toggle Help** button is pressed.

**Table 2-19. Events Configuration Parameters**

Web Page Item	Description
Enable Event Generation ?	The device will send HTTP POST events to the specified remote server and port number whenever a certain action takes place. Select an event type below to generate an HTTP POST event.
<b>Events</b>	
Enable Call Start Events ?	When selected, the device will report the start of a SIP call.
Enable Call Terminated Events ?	When selected, the device will report the end of a SIP call.
Enable Relay Activated Events ?	When selected, the device will report relay activation.
Enable Relay Deactivated Events ?	When selected, the device will report relay deactivation.
Enable Night Ring Events ?	When selected, the device will report when it starts ringing upon an incoming SIP call to the Nightringer extension. As a reminder, the Nightringer extension always rings upon an incoming SIP call and it is not possible to alter this behavior.
Enable Power On Events ?	When selected, the device will report when it boots.
Enable Multicast Start Events ?	When selected, the device will report when the device starts playing a multicast audio stream.
Enable Multicast Stop Events ?	When selected, the device will report when the device stops playing a multicast audio stream.
Enable Sensor Events ?	When selected, the device will report when the on-board sensor is activated.
Enable 60 Second Heartbeat Events ?	When enabled, the device will report a Heartbeat event every 60 seconds. SIP registration is not required to generate Heartbeat events.
Check All	Click on <b>Check All</b> to select all of the events on the page.
Uncheck All	Click on <b>Uncheck All</b> to de-select all of the events on the page.
<b>Event Server</b>	
Server IP Address ?	The IPv4 address of the event server in dotted decimal notation.
Server Port ?	Specify the event server port number. The supported range is 0-65536. Enter up to 5 digits.
Server URL ?	Generally, the destination URL is the name of the application that receives the events and the string in the HTTP POST command. It can be a script used to parse and process the HTTP POST events. Enter up to 127 characters.
	Click the <b>Save</b> button to save your configuration settings. <b>Note:</b> You need to reboot for changes to take effect.
	Click on the <b>Reboot</b> button to reboot the system.

**Table 2-19. Events Configuration Parameters(continued)**

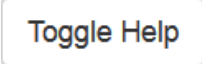
Web Page Item	Description
	Click on the <b>Toggle Help</b> button to see a short description of some of the web page items. First click on the <b>Toggle Help</b> button, and you will see a question mark (?) appear next to some of the web page items. Move the mouse pointer to hover over a question mark to see a short description of a specific web page item.

**Note** You must click on the **Save** button and then the **Reboot** button for the changes to take effect.



### 2.3.11.1 Example Packets for Events

The server and port are used to point to the listening server and the 'Remote Event Server URL' is the destination URL (typically the script running on the remote server that's used to parse and process the POST events).

**Note** The XML is URL-encoded before transmission so the following examples are not completely accurate.

Here are example packets for every event:

```
POST xmlparse_engine HTTP/1.1
Host: 10.0.3.79
User-Agent: CyberData/1.0.0
Content-Length: 197
Content-Type: application/x-www-form-urlencoded

<?xml version="1.0" encoding="ISO-8859-1"?>
<cyberdata NAME='CyberData VoIP Device' MAC='0020f70015b6'>
<event>POWERON</event>
</cyberdata>
```

```
POST xmlparse_engine HTTP/1.1
Host: 10.0.3.79
User-Agent: CyberData/1.0.0
Content-Length: 199
Content-Type: application/x-www-form-urlencoded

<?xml version="1.0" encoding="ISO-8859-1"?>
<cyberdata NAME='CyberData VoIP Device' MAC='0020f70015b6'>
<event>HEARTBEAT</event>
</cyberdata>
```

```
POST xmlparse_engine HTTP/1.1
Host: 10.0.3.79
User-Agent: CyberData/1.0.0
Content-Length: 196
Content-Type: application/x-www-form-urlencoded

<?xml version="1.0" encoding="ISO-8859-1"?>
<cyberdata NAME='CyberData VoIP Device' MAC='0020f70015b6'>
<event>BUTTON</event>
</cyberdata>
```

```
POST xmlparse_engine HTTP/1.1
Host: 10.0.3.79
User-Agent: CyberData/1.0.0
Content-Length: 201
Content-Type: application/x-www-form-urlencoded

<?xml version="1.0" encoding="ISO-8859-1"?>
<cyberdata NAME='CyberData VoIP Device' MAC='0020f70015b6'>
<event>CALL_ACTIVE</event>
</cyberdata>
POST xmlparse_engine HTTP/1.1
Host: 10.0.3.79
```

```
User-Agent: CyberData/1.0.0
Content-Length: 205
Content-Type: application/x-www-form-urlencoded

<?xml version="1.0" encoding="ISO-8859-1"?>
<cyberdata NAME='CyberData VoIP Device' MAC='0020f70015b6'>
<event>CALL_TERMINATED</event>
</cyberdata>

POST xmlparse_engine HTTP/1.1
Host: 10.0.3.79
User-Agent: CyberData/1.0.0
Content-Length: 197
Content-Type: application/x-www-form-urlencoded

<?xml version="1.0" encoding="ISO-8859-1"?>
<cyberdata NAME='CyberData VoIP Device' MAC='0020f70015b6'>
<event>RINGING</event>
</cyberdata>

POST xmlparse_engine HTTP/1.1
Host: 10.0.3.79
User-Agent: CyberData/1.0.0
Content-Length: 234
Content-Type: application/x-www-form-urlencoded

<?xml version="1.0" encoding="ISO-8859-1"?>
<cyberdata NAME='CyberData VoIP Device' MAC='0020f70015b6'>
<event>MULTICAST_START</event>
<index>8</index>
</cyberdata>

POST xmlparse_engine HTTP/1.1
Host: 10.0.3.79
User-Agent: CyberData/1.0.0
Content-Length: 233
Content-Type: application/x-www-form-urlencoded

<?xml version="1.0" encoding="ISO-8859-1"?>
<cyberdata NAME='CyberData VoIP Device' MAC='0020f70015b6'>
<event>MULTICAST_STOP</event>
<index>8</index>
</cyberdata>

POST xmlparse_engine HTTP/1.1
Host: 10.0.3.79
User-Agent: CyberData/1.0.0
Content-Length: 234
Content-Type: application/x-www-form-urlencoded
<?xml version="1.0" encoding="ISO-8859-1"?>
<cyberdata NAME='CyberData VoIP Device' MAC='0020f70015b6'>
<event>RELAY_ACTIVATED</event>
</cyberdata>
POST xmlparse_engine HTTP/1.1
Host: 10.0.3.79
```

```
User-Agent: CyberData/1.0.0
Content-Length: 234
Content-Type: application/x-www-form-urlencoded
<?xml version="1.0" encoding="ISO-8859-1"?>
<cyberdata NAME='CyberData VoIP Device' MAC='0020f70015b6'>
<event>RELAY_DEACTIVATED</event>
</cyberdata>
```

```
POST xmlparse_engine HTTP/1.1
Host: 10.0.3.79
User-Agent: CyberData/1.0.0
Content-Length: 234
Content-Type: application/x-www-form-urlencoded
<?xml version="1.0" encoding="ISO-8859-1"?>
<cyberdata NAME='CyberData VoIP Device' MAC='0020f70015b6'>
<event>NIGHTRINGING</event>
</cyberdata>
```

## 2.3.12 Configure the Autoprovisioning Parameters

Autoprovisioning can be used to automatically configure your device. The autoprovisioning file is an xml file with the device configuration. Values found in this file will override values stored in on-board memory.

**Note** By default, the device will try to set up its configuration with autoprovisioning.

1. Click the **Autoprov** menu button to open the **Autoprovisioning** page. See [Figure 2-32](#).

**Figure 2-32. Autoprovisioning Page**

Home Device Network SIP Multicast Sensor Audiofiles Events Autoprov Firmware

# Singlewire V3.1 Speaker

Disable Autoprovisioning:

Autoprovisioning Server:

Autoprovisioning Filename:

Use tftp:

Username:

Password:

Autoprovisioning autoupdate (in minutes): 0

Autoprovision at time (HHMMSS):

Autoprovision when idle (in minutes > 10): 0

See the manual to learn how to use autoprovisioning to configure your device.  
Autoprovisioning happens on boot.  
The device will first look for a configured server address and filename.  
If these haven't been configured, it will look for an autoprovisioning server in your list of DHCP options and try to download '0002c1812aa6.xml' and if this fails, '000000cd.xml'.

Save Reboot Toggle Help

Download Template

Autoprovisioning log

```
00:00 Autoprovisioning Device...
00:00 Autoprov found option 43 in DHCP server="http://chalmers.cyberdata.net"
00:00 Autoprov looking for 0002c1812aa6.xml at http://chalmers.cyberdata.net
00:00 Autoprov looking for 000000cd.xml at http://chalmers.cyberdata.net
00:00 Failed to fetch autoprov file
00:00 Autoprov found option 72 in DHCP server="10.0.1.118"
00:00 Autoprov looking for 0002c1812aa6.xml at 10.0.1.118
00:00 Autoprov looking for 000000cd.xml at 10.0.1.118
00:00 Failed to fetch autoprov file
00:00 Autoprov found option 150 in DHCP server="10.0.5.120"
```



- On the **Autoprovisioning** page, you may enter values for the parameters indicated in [Table 2-20](#).

**Note** The question mark icon (?) in the following table shows which web page items will be defined after the **Toggle Help** button is pressed.

**Table 2-20. Autoprovisioning Configuration Parameters**

Web Page Item	Description
Disable Autoprovisioning ?	Prevent the device from automatically trying to download a configuration file. See <a href="#">Section 2.3.12.1, "Autoprovisioning"</a> for more information.
Autoprovisioning Server ?	Enter the IPv4 address of the provisioning server in dotted decimal notation.
Autoprovisioning Filename ?	<p>The autoprovisioning filename is the configuration filename. The default autoprovisioning filename is in the format of <b>&lt;mac address&gt;.xml</b>.</p> <p>Supported filename extensions are .txt, and .xml. The current filename is denoted by an asterisk at the bottom of the <a href="#">Autoprovisioning Page</a>. Enter up to 256 characters.</p> <p>A file may have any name with an xml extension. If a file name is entered, the device will look for the specified file name, and only that file.</p>
Use tftp ?	The device will use TFTP (instead of http) to download autoprovisioning files.
Username ?	The username used to authenticate with an autoprovisioning server. Leave this field blank to disable authentication.
Password ?	The password used to authenticate with an autoprovisioning server. Leave this field blank to disable authentication.
Autoprovisioning Autoupdate (in minutes) ?	<p>The reoccurring time (in minutes) the device will wait before checking for new autoprovisioning files. Enter up to 6 digits. A value of 0 will disable this option.</p> <p><b>Note:</b> To use the auto update options, enable the <a href="#">Set Time with NTP Server on boot</a> setting on the <a href="#">Device Configuration Page</a> page (see <a href="#">Table 2-7</a>).</p>
Autoprovision at time (HHMMSS) ?	<p>The time of day the device will check for a new autoprovisioning file. The time must be 6 characters in length and in HHMMSS format. An empty value will disable this option.</p> <p><b>Note:</b> To use the auto update options, enable the <a href="#">Set Time with NTP Server on boot</a> setting on the <a href="#">Device Configuration Page</a> page (see <a href="#">Table 2-7</a>).</p>
Autoprovision when idle (in minutes > 10) ?	<p>The idle time (in minutes greater than 10) after which the device will check for a new autoprovisioning file. Enter up to 6 digits. A value of 0 will disable this option.</p> <p><b>Note:</b> To use the auto update options, enable the <a href="#">Set Time with NTP Server on boot</a> setting on the <a href="#">Device Configuration Page</a> page (see <a href="#">Table 2-7</a>).</p>
	<p>Click the <b>Save</b> button to save your configuration settings.</p> <p><b>Note:</b> You need to reboot for changes to take effect.</p>

**Table 2-20. Autoprovisioning Configuration Parameters (continued)**

Web Page Item	Description
	Click on the <b>Reboot</b> button to reboot the system.
	Click on the <b>Toggle Help</b> button to see a short description of some of the web page items. First click on the <b>Toggle Help</b> button, and you will see a question mark (?) appear next to some of the web page items. Move the mouse pointer to hover over a question mark to see a short description of a specific web page item.
	Press the <b>Download Template</b> button to create an autoprovisioning file for the device. See <a href="#">Section 2.3.12.3, "Download Template Button"</a>
Autoprovisioning log	The autoprovisioning log provides information about the latest autoprovisioning attempt (i.e. dhcp options and server accessed and files parsed or not found).

**Note** You must click on the **Save** button and then the **Reboot** button for the changes to take effect.

### 2.3.12.1 Autoprovisioning

On boot, the device will look for an autoprovisioning server configured on the [Autoprovisioning Page](#) or specified as a DHCP option. When it finds a server, it will try to download the following (in order of preference):

1. The file configured on the autoprovisioning page.
2. A file named according to it's mac address (for example: 0020f7350058.xml).
3. The file 000000cd.xml

The file can be hosted using a standard web server (like apache, IIS, or nginx), and the device can download over SSL. The file server can be an ipv4 address in dotted decimal notation or a fully qualified domain name.

By default, the device will get its autoprovisioning server from the DHCP options. See [Section 2.3.12.2, "Sample dhcpd.conf"](#) for an example of how to configure dhcpd to offer autoprovisioning server addresses. If multiple options are set, the device will attempt to download autoprovisioning files from every server.

The DHCP option determines the protocol used to download the autoprovisioning file. The device looks for DHCP options in the following order:

1. Option 43 - a FQDN or an IP address to an http server
2. Option 72 - an IP address to an http server
3. Option 150 - an IP address to a tftp server
4. Option 66 - an IP address to a tftp server or if the entry starts with 'http', a FQDN to a http server.

You can download an autoprovisioning template file from the [Autoprovisioning Page](#) using the **Download Template** button (see [Table 2-20](#)). This file contains every configuration option that can be set on the board.

Autoprovisioning files can contain the whole configuration or a subset of this file. The first autoprovisioning file can also contain links to other autoprovisioning files.

The <MiscSettings> section contains some examples of additional autoprovisioning files:

```
<MiscSettings>
  <DeviceName>CyberData VoIP Device</DeviceName>
<!-- <AutprovFile>common.xml</AutprovFile>-->
<!-- <AutprovFile>sip_reg[macaddress].xml</AutprovFile>-->
<!-- <AutprovFile>audio[macaddress]</AutprovFile>-->
<!-- <AutprovFile>device[macaddress].xml</AutprovFile>-->
</MiscSettings>
```

After downloading the first autoprovisioning file, the device will step through up to twenty additional <AutprovFile> entries and try to download these files from the same server.

When the device finds a filename with the string **[macaddress]**, it will replace this string with the mac address.

As an example, the user has configured option 43 on their DHCP server to “http://example.com,” and on their server, they have a file named **0020f7123456.xml** (the same as the mac address of the device).

The file 0020f7123456.xml contains:

```
<?xml version="1.0" encoding="utf-8" ?>
<specific>
  <MiscSettings>
    <DeviceName>Newname</DeviceName>
    <AutoprovFile>common.xml</AutoprovFile>
    <AutoprovFile>sip_reg[macaddress].xml</AutoprovFile>
    <AutoprovFile>audio[macaddress]</AutoprovFile>
    <AutoprovFile>device.xml</AutoprovFile>
  </MiscSettings>
</specific>
```

1. The device will first set its name to 'Newname'.
2. It will try to download <http://example.com/common.xml>.
3. It will try to download [http://example.com/sip\\_reg0020f7123456.xml](http://example.com/sip_reg0020f7123456.xml).
4. It will try to download <http://example.com/audio0020f7123456>.
5. It will try to download <http://example.com/device.xml>.

The device is reconfigured every time it downloads a new file so if two files configure the same option the last one will be the one that is saved.

It is possible to autoprovision autoprovisioning values (for example, to disable autoprovisioning or to configure a time to check for new files).

Checking for New  
Autoprovisioning  
Files after Boot

The device will always check for an autoprovisioning files on boot but it can be configured to also check after a periodic delay, when idle, or at a specified time. When one of these options is set, the device will download its autoprovisioning files again, and if it finds any differences from the files it downloaded on boot, it will force a reboot and reconfigure.



The Autoprovisioning Filename

The autoprovisioning filename can contain a file, a file path, or a directory.

**Table 2-21. Autoprovisioning File Name**

<b>Autoprovisioning Filename</b>	<b>Autoprovisioning Server</b>	<b>File Downloaded</b>
config.xml	10.0.1.3	10.0.1.3/config.xml
/path/to/config.xml	10.0.1.3	10.0.1.3/path/to/config.xml
subdirectory/path/	10.0.1.3	10.0.1.3/subdirectory/path/0020f7020002.xml

TFTP options may not support subdirectories. If a directory is set in the filename field, firmware and audio files will also be downloaded from this subdirectory.

If the filename ends with a forward slash “/,” the device will treat it as a subdirectory.

For example:

The autoprovisioning server is set to “https://www.example.com”

The autoprovisioning filename is set to “cyberdata/”

On boot, the device will try to download:

https://www.example.com/cyberdata/0020f7123456.xml

...and if this fails:

https://www.example.com/cyberdata/000000cd.xml

Audio files and firmware files will also add “cyberdata” to the URL before downloading.

```

Autoprovisioning <FirmwareSettings>
Firmware Updates <FirmwareFile>505-uImage-ceilingsspeaker</FirmwareFile>
                  <FirmwareServer>10.0.1.3</FirmwareServer>
                  <OutdoorIntercom30>firmware_file_v9.3.0</OutdoorIntercom30>
                  <OutdoorIntercom31>firmware_file_v10.3.0</OutdoorIntercom31>
                  <CallButton31>firmware_file_v10.3.0</CallButton31>
                  </FirmwareSettings>

```

In the <FirmwareSettings> section, the <FirmwareServer> element can be used to specify a different server for hosting firmware files. When this element is not available, the device will try to download the file from the autoprovisioning server.

The device will use the filename to determine when to autoprovision firmware updates. The default configuration is blank, so the first time you set a value in your autoprovisioning file, it may force a firmware update even if the firmware version has not changed.

The <FirmwareFile> name can contain path elements (i.e. /path/to/firmware/10.3.0-ulmage-[device\_file\_name]).

The device also supports product strings for downloading firmware. If the <FirmwareFile> option is not set, the device will look for its particular product string for a firmware filename. In this way, a generic autoprovisioning file can specify unique firmware for a range of products.

The list of valid product strings:

```

<ProductString>CallButton31</ProductString>
<ProductString>EmergencyIntercom31</ProductString>
<ProductString>EmergencyIntercom31SW</ProductString>
<ProductString>IndoorIntercom31</ProductString>
<ProductString>IndoorIntercom31SW</ProductString>
<ProductString>IndoorKeypad31</ProductString>
<ProductString>IndoorKeypad31SW</ProductString>
<ProductString>OfficeRinger31</ProductString>
<ProductString>OfficeRinger31SW</ProductString>
<ProductString>OutdoorIntercom31</ProductString>
<ProductString>OutdoorIntercom31SW</ProductString>
<ProductString>OutdoorKeypad31</ProductString>
<ProductString>OutdoorKeypad31SW</ProductString>
<ProductString>Strobe31</ProductString>
<ProductString>Strobe31SW</ProductString>

```

Autoprovisioning  
Example 1

Here's a simple example using four autoprovisioning files to configure two devices:

We boot up two devices with mac addresses **00:20:f7:02:00:01** and **00:20:f7:02:00:02** (Device1 and Device2).

The devices are set to use DHCP and that server provides an autoprovisioning server address with option 43. The address is "https://autoprovtest.server.net." The files on this server are as follows:

**000000cd.xml**

```
<MiscSettings>
<DeviceName>CyberData Autoprovisioned</DeviceName>
<AutprovFile>sip_common.xml</AutprovFile>
<AutprovFile>sip_[macaddress].xml</AutprovFile>
</MiscSettings>
```

**sip\_common.xml**

```
<SIPSettings>
<SIPServer>10.0.0.253</SIPServer>
<RemoteSIPPort>5060</RemoteSIPPort>
</SIPSettings>
```

**sip\_0020f7020001.xml**

```
<SIPSettings>
<SIPUserID>198</SIPUserID>
<SIPAuthPassword>ext198</SIPAuthPassword>
<DialoutExtension0>204</DialoutExtension0>
</SIPSettings>
```

**sip\_0020f7020002.xml**

```
<SIPSettings>
<SIPUserID>500</SIPUserID>
<SIPAuthPassword>ext500</SIPAuthPassword>
<DialoutExtension0>555</DialoutExtension0>
</SIPSettings>
```

On boot, Device1 tries to fetch the file **0020f7023614.xml** from "https://autoprovtest.server.net". This file is not available, so device1 then tries to fetch the file **000000cd.xml**. This file exists, and Device1 parses the three elements.

1. Device1 changes its device name to **CyberData Autoprovisioned**.
2. Device1 finds an AutprovFile element containing the filename **sip\_common.xml**. The device downloads **sip\_common.xml** from "https://autoprovtest.server.net," and imports this configuration, setting the sip server to **10.0.0.253** and the remote port to **5060.3**.
3. Device1 finds another AutprovFile element containing the filename **sip\_[macaddress].xml**. The device replaces the **[macaddress]** with its own mac address value creating **sip\_0020f7020001.xml**, downloads this file from "https://autoprovtest.server.net," and imports this configuration. This sets the user ID to **198**, the password to **ext198**, and the dialout extension to **204**. Device1 is now finished with autoprovisioning.

Device2 goes through the same steps by setting its device name to **CyberData Autoprovisioned**, its SIP server to **10.0.0.253**, and its port to **5060**. When Device2 “sees” **sip\_[macaddress].xml**, Device2 replaces it with its own mac address and downloads **sip\_0020f7020002.xml** from “https://autoprovtest.server.net.” Device2 sets the SIP User ID to **500**, the password to **ext500**, and the dialout extension to **555**.

#### Autoprovisioning Example 2

Here is another example of setting up your autoprovisioning files:

We boot up two devices with mac addresses **00:20:f7:02:00:01** and **00:20:f7:02:00:02** (Device1 and Device2) and boot them on a network with a DHCP server configured with an autoprovisioning server at **10.0.1.3** on option **150**. Our TFTP server has three files:

##### **0020f7020001.xml**

```
<MiscSettings>
<AutoprovFile>common_settings.xml</AutoprovFile>
</MiscSettings>
<SIPSettings>
<SIPUserID>198</SIPUserID>
<SIPAuthPassword>ext198</SIPAuthPassword>
<DialoutExtension0>204</DialoutExtension0>
</SIPSettings>
```

##### **0020f7020002.xml**

```
<MiscSettings>
<AutoprovFile>common_settings.xml</AutoprovFile>
</MiscSettings>
<SIPSettings>
<SIPUserID>500</SIPUserID>
<SIPAuthPassword>ext500</SIPAuthPassword>
<DialoutExtension0>555</DialoutExtension0>
</SIPSettings>
```

##### **common\_settings.xml**

```
<MiscSettings>
<DeviceName>CyberData Autoprovisioned</DeviceName>
</MiscSettings>
<SIPSettings> <SIPServer>10.0.0.253</SIPServer>
<RemoteSIPPort>5060</RemoteSIPPort>
</SIPSettings>
```

1. On boot, Device1 downloads **0020f7020001.xml** from **10.0.1.3** and imports these values. The SIP User ID is **198**, the password is **ext198**, and the dialout extension is **204**.

2. Device1 then gets the filename **common\_settings.xml** from the AutoprovFile element and downloads this file from the TFTP server at **10.0.1.3**. and imports these settings. The device name is set to **CyberData Autoprovisioned**, the SIP server is set to **10.0.0.253**, and the port is set to **5060**.

Device2 does the same except it downloads **0020f7020002.xml** on boot and imports these values instead. The Sip User ID is **500**, password is **ext500**, and dialout extension is **555**. Device2 then downloads the **common\_settings.xml** file and imports those values. The device name is set to **CyberData Autoprovisioned**, the SIP server is set to **10.0.0.253**, and the port is set to **5060**.

## XML Files

XML files can contain <AutoprovFile> elements. If multiple DHCP options are specified, the device will try to download autoprovisioning files from each in turn. The device will only look for <AutoprovFile> elements in the first file downloaded from each server. You can specify up to 20 <AutoprovFile> elements in the first autoprovisioning file.

There are numerous ways to change an element of the **configuration(xml)** file. Using **sip ext** as an example, the extension can be changed:

Within the device-specific xml, i.e. **[macaddress].xml**, via the AutoprovFile element:<SIPSettings>/<SIPExt>

From the device specific xml, a pointer to a sip\_common file

From the device specific xml, a pointer to the device specific sip\_[macaddress].xml

From the common file, a pointer to sip\_common.xml

From the common file, a pointer to the device specific (sip\_[macaddress].xml)

## Autoprovisioned Audio Files

Audio files are stored in non-volatile memory and an autoprovisioned audio file will only have to be downloaded once for each device. Loading many audio files to the device from the web page could cause it to appear unresponsive. If this happens, wait until the transfer is complete and then refresh the page.

The device uses the file name to determine when to download a new audio file. This means that if you used autoprovisioning to upload a file and then changed the contents of this file at the TFTP server, the device will not recognize that the file has changed (because the file name is the same).

Since audio files are stored in non-volatile memory, if autoprovisioning is disabled after they have been loaded to the board, the audio file settings will not change. You can force a change to the audio files on the board by clicking **Restore Default** on the **Audio Configuration** page or by changing the autoprovisioning file with “**default**” set as the file name.

## 2.3.12.2 Sample dhcpd.conf

```
#
# Sample configuration file for ISC dhcpd for Debian
#

ddns-update-style none;

option domain-name "voiplab";
option domain-name-servers 10.0.0.252;
option option-150 code 150 = ip-address;
option ntp-servers north-america.pool.ntp.org;
option space VendorInfo;
option VendorInfo.text code 10 = { text };
authoritative;
log-facility local7;

subnet 10.0.0.0 netmask 255.0.0.0 {
    max-lease-time 3600;
    default-lease-time 3600;

    option routers                10.0.0.1;
    option subnet-mask            255.0.0.0;

    option domain-name            "voiplab";
    option domain-name-servers    10.0.0.252;

    option time-offset            -8;                # Pacific Standard Time

#   option www-server             99.99.99.99;        # OPTION 72

#   option tftp-server-name       "10.0.1.52";        # OPTION 66
#   option tftp-server-name       "http://test.cyberdata.net"; # OPTION 66

#   option option-150            10.0.0.252;        # OPTION 150

# These two lines are needed for option 43
#   vendor-option-space VendorInfo;                # OPTION 43
#   option VendorInfo.text "http://test.cyberdata.net"; # OPTION 43

    range 10.10.0.1 10.10.2.1; }
}
```

### 2.3.12.3 Download Template Button

The **Download Template** button allows the user to generate, download, edit, and then store an autoprovisioning template on the server that serves the autoprovisioning files for devices.

To generate an autoprovisioning template directly from the device, complete the following steps:

1. On the **Autoprovisioning** page, click on the **Download Template** button.
2. You will see a window prompting you to save a configuration file (**.xml**) to a location on your computer ([Figure 2-33](#)). The configuration file is the basis for the default configuration settings for your unit).
3. Choose a location to save the configuration file and click on **OK**. See [Figure 2-33](#).

**Figure 2-33. Configuration File**

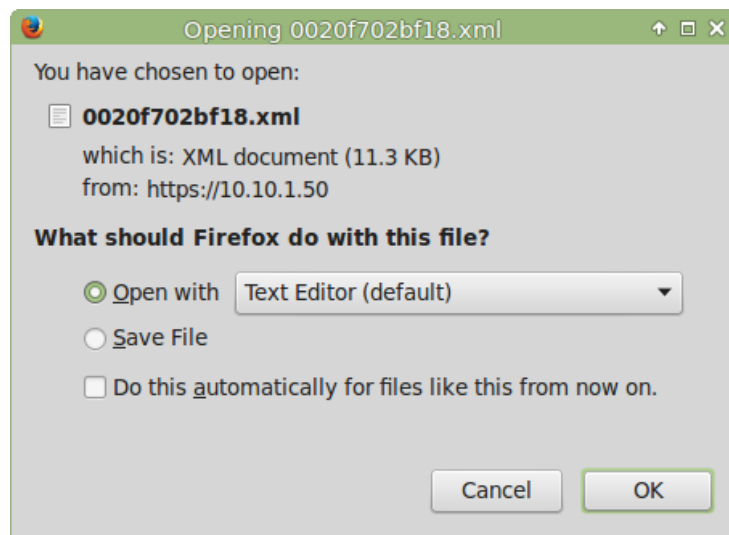

4. At this point, you can open and edit the autoprovisioning template to change the configuration settings in the template for the unit.
5. You can then upload the autoprovisioning file to a TFTP or HTTP server where the file can be loaded onto other devices.

---

## 2.4 Upgrade the Firmware and Reboot the Singlewire InformaCast Talk-Back Speaker

---

### 2.4.1 Downloading the Firmware

To download the firmware to your computer:

1. Download the latest firmware file from the **Downloads** tab at the following webpage:  
<http://www.cyberdata.net/voip/011399/>
2. Unzip the firmware version file. This file may contain the following:
  - Firmware file
  - Release notes
3. Log in to the home page as instructed in [Section 2.3.4, "Log in to the Configuration Home Page"](#).



- Click on the **Firmware** menu button to open the **Firmware** page. See [Figure 2-34](#).

 GENERAL ALERT	<p><b>Caution</b></p> <p><b>Equipment Hazard:</b> CyberData strongly recommends that you first reboot the device before attempting to upgrade the firmware of the device. See <a href="#">Section 2.4.2</a>, "Reboot the Device".</p>
--	---

**Figure 2-34. Firmware Page**





- Click on the **Browse** button, and then navigate to the location of the firmware file.
- Select the firmware file.
- Click on the **Upload** button.

**Note** Do not reboot the device after clicking on the **Upload** button.

**Note** This starts the upgrade process. Once the Singlewire InformaCast Talk-Back Speaker has uploaded the file, the **Uploading Firmware** countdown page appears, indicating that the firmware is being written to flash. The Singlewire InformaCast Talk-Back Speaker will automatically reboot when the upload is complete. When the countdown finishes, the **Firmware** page will refresh. The uploaded firmware filename should be displayed in the system configuration (indicating a successful upload and reboot).

- [Table 2-22](#) shows the web page items on the **Firmware** page.

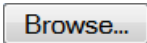
**Table 2-22. Firmware Parameters**

Web Page Item	Description
Current Firmware Version	Shows the current firmware version.
	Use the <b>Browse</b> button to navigate to the location of the firmware file that you want to upload.
	Click on the <b>Upload</b> button to automatically upload the selected firmware and reboot the system.

## 2.4.2 Reboot the Device

To reboot a Singlewire InformaCast Talk-Back Speaker, log in to the web page as instructed in [Section 2.3.4, "Log in to the Configuration Home Page"](#).

1. Click on the **Reboot** button on the **Home** page ([Figure 2-35](#)). A normal restart will occur.

Figure 2-35. Home Page

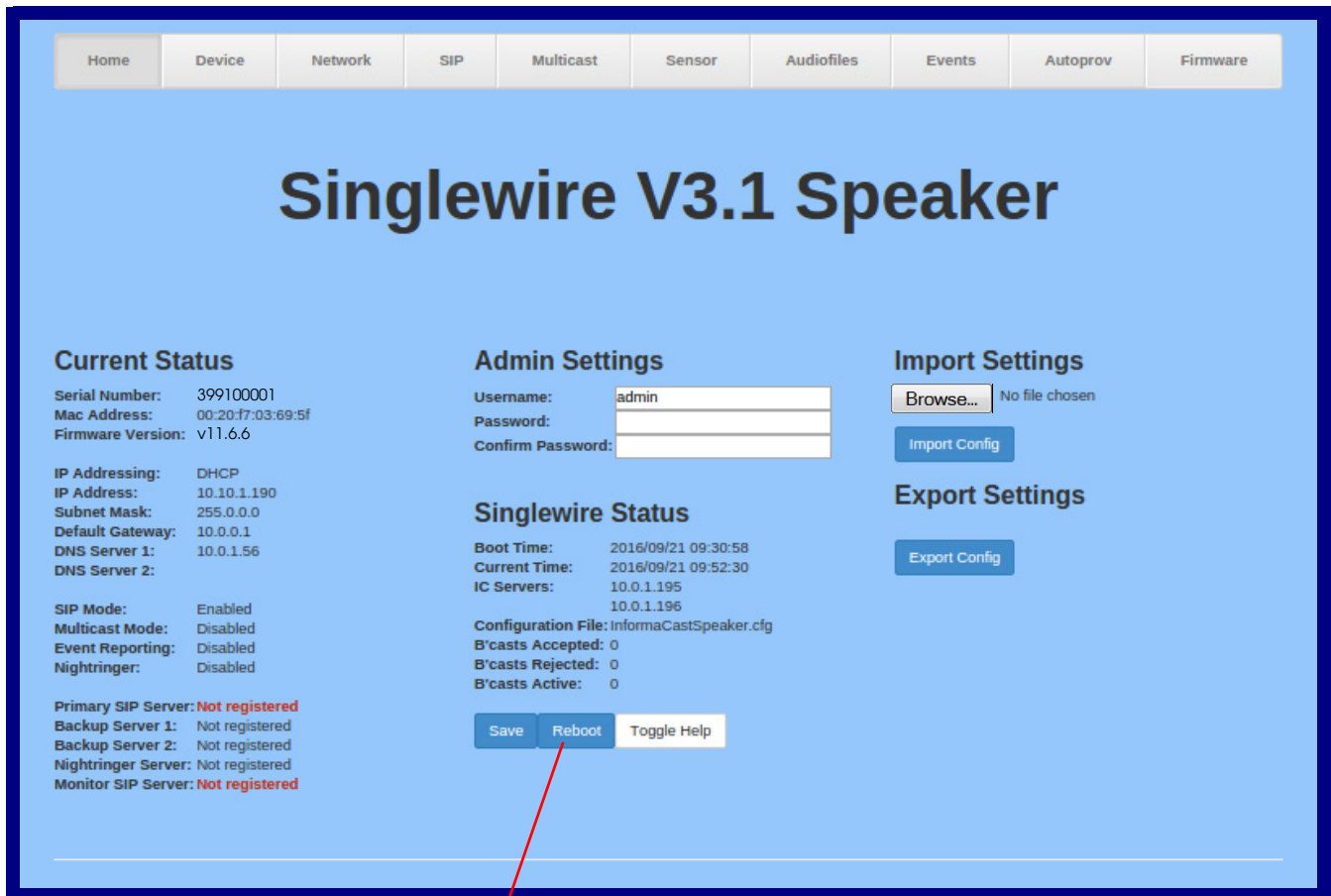

Reboot

## 2.5 Command Interface

Some functions on the device can be activated using simple POST commands to the web interface. The examples in [Table 2-23](#) use the free unix utility, **wget**, but any program that can send http POST commands to the device should work.

### 2.5.1 Command Interface Post Commands

**Note** These commands require an authenticated session (a valid username and password to work).

**Table 2-23. Command Interface Post Commands**

Device Action	HTTP Post Command <sup>a</sup>
Trigger relay (for configured delay)	wget --user admin --password admin --auth-no-challenge --no-check-certificate --quiet -O /dev/null "https://10.0.3.71/cgi-bin/command.cgi" --post-data "test_relay=yes"
Place call to extension (example: extension 130)	wget --user admin --password admin --auth-no-challenge --no-check-certificate --quiet -O /dev/null "https://10.0.3.71/cgi-bin/command.cgi" --post-data "call=130"
Terminate active call	wget --user admin --password admin --auth-no-challenge --no-check-certificate --quiet -O /dev/null "https://10.0.3.71/cgi-bin/command.cgi" --post-data "terminate=yes"
Force reboot	wget --user admin --password admin --auth-no-challenge --no-check-certificate --quiet -O /dev/null "https://10.0.3.71/cgi-bin/command.cgi" --post-data "reboot=yes"
Test Audio button	wget --user admin --password admin --auth-no-challenge --no-check-certificate --quiet -O /dev/null "https://10.0.3.71/cgi-bin/command.cgi" --post-data "test_audio=yes"
Announce IP address	wget --user admin --password admin --auth-no-challenge --no-check-certificate --quiet -O /dev/null "https://10.0.3.71/cgi-bin/command.cgi" --post-data "speak_ip_address=yes"
Play the "0" audio file	wget --user admin --password admin --auth-no-challenge --no-check-certificate --quiet -O /dev/null "https://10.0.3.71/cgi-bin/audiofiles.cgi" --post-data "play_0=yes"
Play the "1" audio file	wget --user admin --password admin --auth-no-challenge --no-check-certificate --quiet -O /dev/null "https://10.0.3.71/cgi-bin/audiofiles.cgi" --post-data "play_1=yes"
Play the "2" audio file	wget --user admin --password admin --auth-no-challenge --no-check-certificate --quiet -O /dev/null "https://10.0.3.71/cgi-bin/audiofiles.cgi" --post-data "play_2=yes"
Play the "3" audio file	wget --user admin --password admin --auth-no-challenge --no-check-certificate --quiet -O /dev/null "https://10.0.3.71/cgi-bin/audiofiles.cgi" --post-data "play_3=yes"
Play the "4" audio file	wget --user admin --password admin --auth-no-challenge --no-check-certificate --quiet -O /dev/null "https://10.0.3.71/cgi-bin/audiofiles.cgi" --post-data "play_4=yes"

**Table 2-23. Command Interface Post Commands (continued)**

<b>Device Action</b>	<b>HTTP Post Command<sup>a</sup></b>
Play the "5" audio file	<code>wget --user admin --password admin --auth-no-challenge --no-check-certificate --quiet -O /dev/null "https://10.0.3.71/cgi-bin/audiofiles.cgi" --post-data "play_5=yes"</code>
Play the "6" audio file	<code>wget --user admin --password admin --auth-no-challenge --no-check-certificate --quiet -O /dev/null "https://10.0.3.71/cgi-bin/audiofiles.cgi" --post-data "play_6=yes"</code>
Play the "7" audio file	<code>wget --user admin --password admin --auth-no-challenge --no-check-certificate --quiet -O /dev/null "https://10.0.3.71/cgi-bin/audiofiles.cgi" --post-data "play_7=yes"</code>
Play the "8" audio file	<code>wget --user admin --password admin --auth-no-challenge --no-check-certificate --quiet -O /dev/null "https://10.0.3.71/cgi-bin/audiofiles.cgi" --post-data "play_8=yes"</code>
Play the "9" audio file	<code>wget --user admin --password admin --auth-no-challenge --no-check-certificate --quiet -O /dev/null "https://10.0.3.71/cgi-bin/audiofiles.cgi" --post-data "play_9=yes"</code>
Play the "Dot" audio file	<code>wget --user admin --password admin --auth-no-challenge --no-check-certificate --quiet -O /dev/null "https://10.0.3.71/cgi-bin/audiofiles.cgi" --post-data "play_d=yes"</code>
Play the "Audio Test" audio file (from Audio Config)	<code>wget --user admin --password admin --auth-no-challenge --no-check-certificate --quiet -O /dev/null "https://10.0.3.71/cgi-bin/audiofiles.cgi" --post-data "play_audiotest=yes"</code>
Play the "Page Tone" audio file	<code>wget --user admin --password admin --auth-no-challenge --no-check-certificate --quiet -O /dev/null "https://10.0.3.71/cgi-bin/audiofiles.cgi" --post-data "play_pagetone=yes"</code>
Play the "Your IP Address Is" audio file	<code>wget --user admin --password admin --auth-no-challenge --no-check-certificate --quiet -O /dev/null "https://10.0.3.71/cgi-bin/audiofiles.cgi" --post-data "play_youripaddressis=yes"</code>
Play the "Rebooting" audio file	<code>wget --user admin --password admin --auth-no-challenge --no-check-certificate --quiet -O /dev/null "https://10.0.3.71/cgi-bin/audiofiles.cgi" --post-data "play_rebooting=yes"</code>
Play the "Restoring Default" audio file	<code>wget --user admin --password admin --auth-no-challenge --no-check-certificate --quiet -O /dev/null "https://10.0.3.71/cgi-bin/audiofiles.cgi" --post-data "play_restoringdefault=yes"</code>
Play the "Ringback tone" audio file	<code>wget --user admin --password admin --auth-no-challenge --no-check-certificate --quiet -O /dev/null "https://10.0.3.71/cgi-bin/audiofiles.cgi" --post-data "play_ringback=yes"</code>
Play the "Ring tone" audio file	<code>wget --user admin --password admin --auth-no-challenge --no-check-certificate --quiet -O /dev/null "https://10.0.3.71/cgi-bin/audiofiles.cgi" --post-data "play_ringtones=yes"</code>
Play the "Intrusion Sensor Triggered" audio file	<code>wget --user admin --password admin --auth-no-challenge --no-check-certificate --quiet -O /dev/null "https://10.0.3.71/cgi-bin/audiofiles.cgi" --post-data "play_intrusionsensortriggered=yes"</code>
Play the "Door Ajar" audio file	<code>wget --user admin --password admin --auth-no-challenge --no-check-certificate --quiet -O /dev/null "https://10.0.3.71/cgi-bin/audiofiles.cgi" --post-data "play_doorajar=yes"</code>
Play the "Night Ring" audio file	<code>wget --user admin --password admin --auth-no-challenge --no-check-certificate --quiet -O /dev/null "https://10.0.3.71/cgi-bin/audiofiles.cgi" --post-data "play_nightring=yes"</code>

**Table 2-23. Command Interface Post Commands (continued)**

<b>Device Action</b>	<b>HTTP Post Command<sup>a</sup></b>
Delete the "0" audio file	<code>wget --user admin --password admin --auth-no-challenge --no-check-certificate --quiet -O /dev/null "https://10.0.3.71/cgi-bin/audiofiles.cgi" --post-data "delete_0=yes"</code>
Delete the "1" audio file	<code>wget --user admin --password admin --auth-no-challenge --no-check-certificate --quiet -O /dev/null "https://10.0.3.71/cgi-bin/audiofiles.cgi" --post-data "delete_1=yes"</code>
Delete the "2" audio file	<code>wget --user admin --password admin --auth-no-challenge --no-check-certificate --quiet -O /dev/null "https://10.0.3.71/cgi-bin/audiofiles.cgi" --post-data "delete_2=yes"</code>
Delete the "3" audio file	<code>wget --user admin --password admin --auth-no-challenge --no-check-certificate --quiet -O /dev/null "https://10.0.3.71/cgi-bin/audiofiles.cgi" --post-data "delete_3=yes"</code>
Delete the "4" audio file	<code>wget --user admin --password admin --auth-no-challenge --no-check-certificate --quiet -O /dev/null "https://10.0.3.71/cgi-bin/audiofiles.cgi" --post-data "delete_4=yes"</code>
Delete the "5" audio file	<code>wget --user admin --password admin --auth-no-challenge --no-check-certificate --quiet -O /dev/null "https://10.0.3.71/cgi-bin/audiofiles.cgi" --post-data "delete_5=yes"</code>
Delete the "6" audio file	<code>wget --user admin --password admin --auth-no-challenge --no-check-certificate --quiet -O /dev/null "https://10.0.3.71/cgi-bin/audiofiles.cgi" --post-data "delete_6=yes"</code>
Delete the "7" audio file	<code>wget --user admin --password admin --auth-no-challenge --no-check-certificate --quiet -O /dev/null "https://10.0.3.71/cgi-bin/audiofiles.cgi" --post-data "delete_7=yes"</code>
Delete the "8" audio file	<code>wget --user admin --password admin --auth-no-challenge --no-check-certificate --quiet -O /dev/null "https://10.0.3.71/cgi-bin/audiofiles.cgi" --post-data "delete_8=yes"</code>
Delete the "9" audio file	<code>wget --user admin --password admin --auth-no-challenge --no-check-certificate --quiet -O /dev/null "https://10.0.3.71/cgi-bin/audiofiles.cgi" --post-data "delete_9=yes"</code>
Delete the "Audio Test" audio file	<code>wget --user admin --password admin --auth-no-challenge --no-check-certificate --quiet -O /dev/null "https://10.0.3.71/cgi-bin/audiofiles.cgi" --post-data "delete_audiotest=yes"</code>
Delete the "Page Tone" audio file	<code>wget --user admin --password admin --auth-no-challenge --no-check-certificate --quiet -O /dev/null "https://10.0.3.71/cgi-bin/audiofiles.cgi" --post-data "delete_pagetone=yes"</code>
Delete the "Your IP Address Is" audio file	<code>wget --user admin --password admin --auth-no-challenge --no-check-certificate --quiet -O /dev/null "https://10.0.3.71/cgi-bin/audiofiles.cgi" --post-data "delete_youripaddressis=yes"</code>
Delete the "Rebooting" audio file	<code>wget --user admin --password admin --auth-no-challenge --no-check-certificate --quiet -O /dev/null "https://10.0.3.71/cgi-bin/audiofiles.cgi" --post-data "delete_rebooting=yes"</code>
Delete the "Restoring Default" audio file	<code>wget --user admin --password admin --auth-no-challenge --no-check-certificate --quiet -O /dev/null "https://10.0.3.71/cgi-bin/audiofiles.cgi" --post-data "delete_restoringdefault=yes"</code>
Delete the "Ringback tone" audio file	<code>wget --user admin --password admin --auth-no-challenge --no-check-certificate --quiet -O /dev/null "https://10.0.3.71/cgi-bin/audiofiles.cgi" --post-data "delete_ringback=yes"</code>

**Table 2-23. Command Interface Post Commands (continued)**

<b>Device Action</b>	<b>HTTP Post Command<sup>a</sup></b>
Delete the "Ring tone" audio file	<code>wget --user admin --password admin --auth-no-challenge --no-check-certificate --quiet -O /dev/null "https://10.0.3.71/cgi-bin/audiofiles.cgi" --post-data "delete_ringtone=yes"</code>
Delete the "Intrusion Sensor Triggered" audio file	<code>wget --user admin --password admin --auth-no-challenge --no-check-certificate --quiet -O /dev/null "https://10.0.3.71/cgi-bin/audiofiles.cgi" --post-data "delete_intrusionsensortriggered=yes"</code>
Delete the "Door Ajar" audio file	<code>wget --user admin --password admin --auth-no-challenge --no-check-certificate --quiet -O /dev/null "https://10.0.3.71/cgi-bin/audiofiles.cgi" --post-data "delete_doorajar=yes"</code>
Delete the "Night Ring" audio file	<code>wget --user admin --password admin --auth-no-challenge --no-check-certificate --quiet -O /dev/null "https://10.0.3.71/cgi-bin/audiofiles.cgi" --post-data "delete_nightring=yes"</code>
Trigger the Door Sensor Test (Sensor Config page)	<code>wget --user admin --password admin --auth-no-challenge --no-check-certificate --quiet -O /dev/null "https://10.0.3.71/cgi-bin/sensor.cgi" --post-data "doortest=yes"</code>
Trigger the Intrusion Sensor Test (Sensor Config page)	<code>wget --user admin --password admin --auth-no-challenge --no-check-certificate --quiet -O /dev/null "https://10.0.3.71/cgi-bin/sensor.cgi" --post-data "intrusiontest=yes"</code>

a. Type and enter all of each http POST command on one line.

## 2.3 Identifying and Testing a Ceiling Speaker when Using InformaCast 8.1 or Later

This section describes the basic process for identifying and testing the CyberData IP Ceiling speaker when using Singlewire's InformaCast software version 4.0 or later.

**Note** If you have questions or need help, please consult your InformaCast documentation and or contact the CyberData support team.

**Note** CyberData's support is limited to IP endpoint functionality when used with an InformaCast system.

To add the Singlewire InformaCast Talk-Back Speaker to the InformaCast server:

1. Click **Edit IP Speakers** on the **Main Screen** of the **Singlewire Informacast Server Web Interface**.

Figure 2-36. Main Screen of the Singlewire InformaCast Server Web Interface

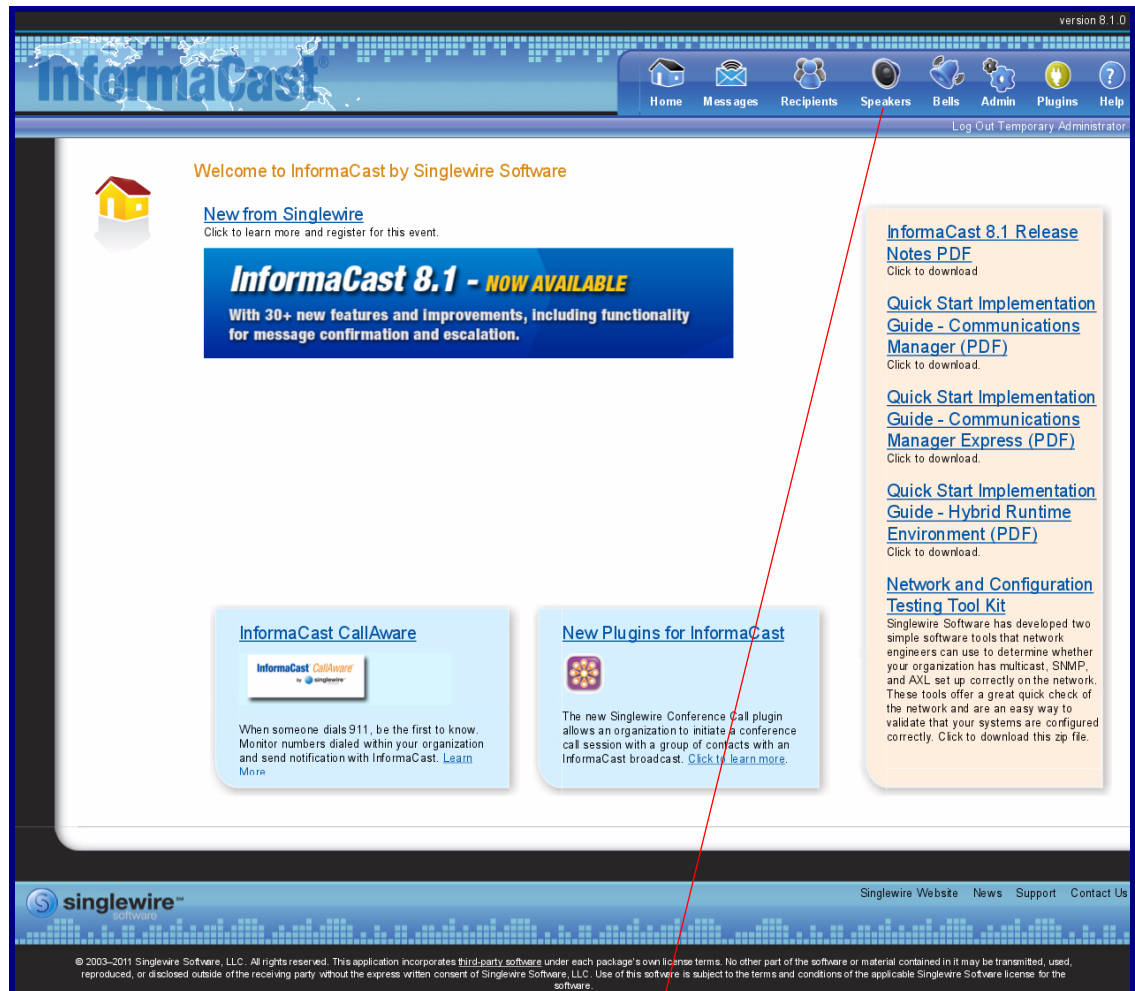

Edit IP Speakers



- On the **IP Speaker Configuration** page, InformaCast will indicate that it has detected new speakers. Click **View**.

Figure 2-37. IP Speaker Configuration Page

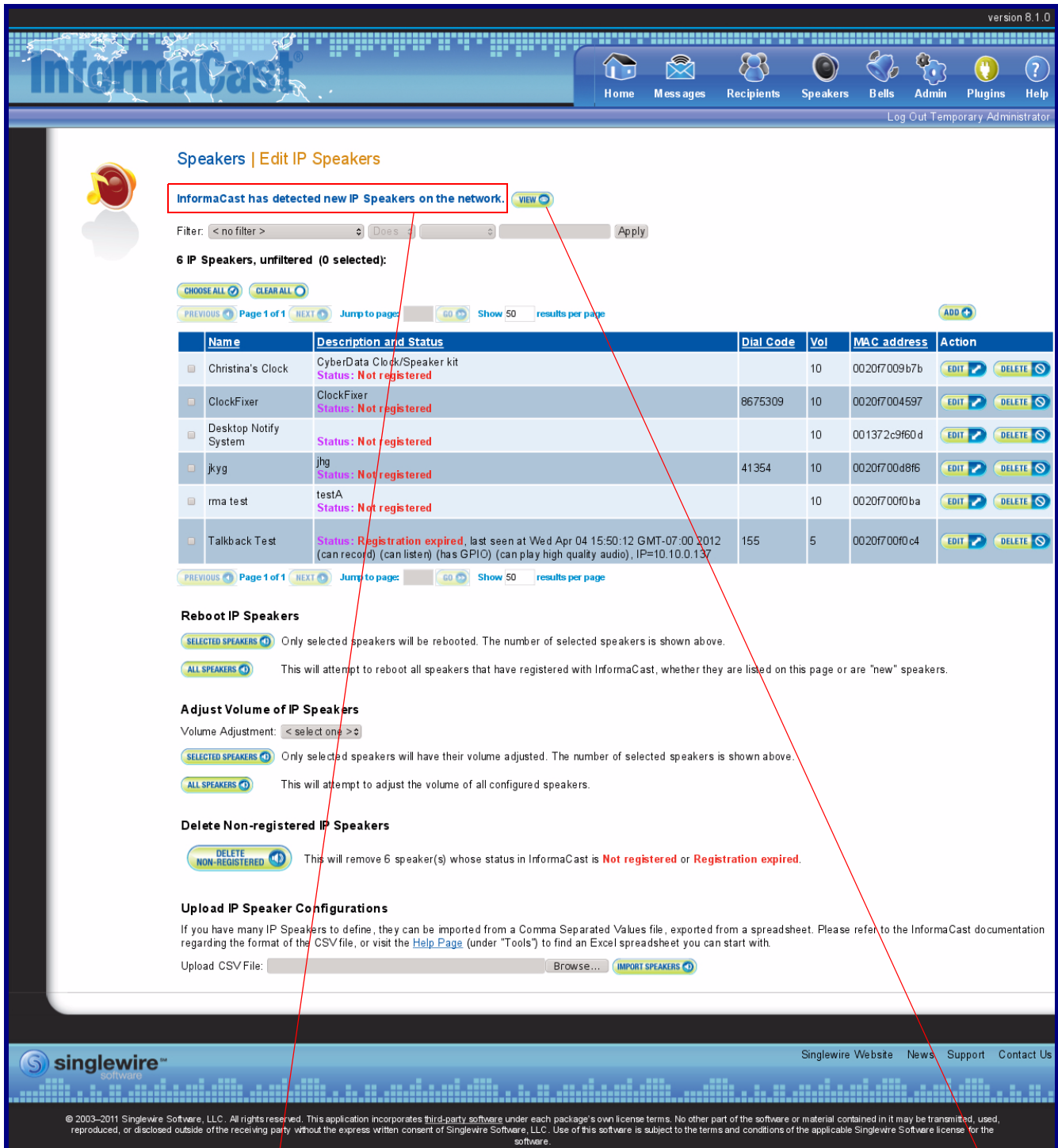

InformaCast has detected new speakers.

View



3. The **IP Speaker Configuration** page will show four newly detected speakers. Click **Test**.

Figure 2-38. IP Speaker Configuration Page

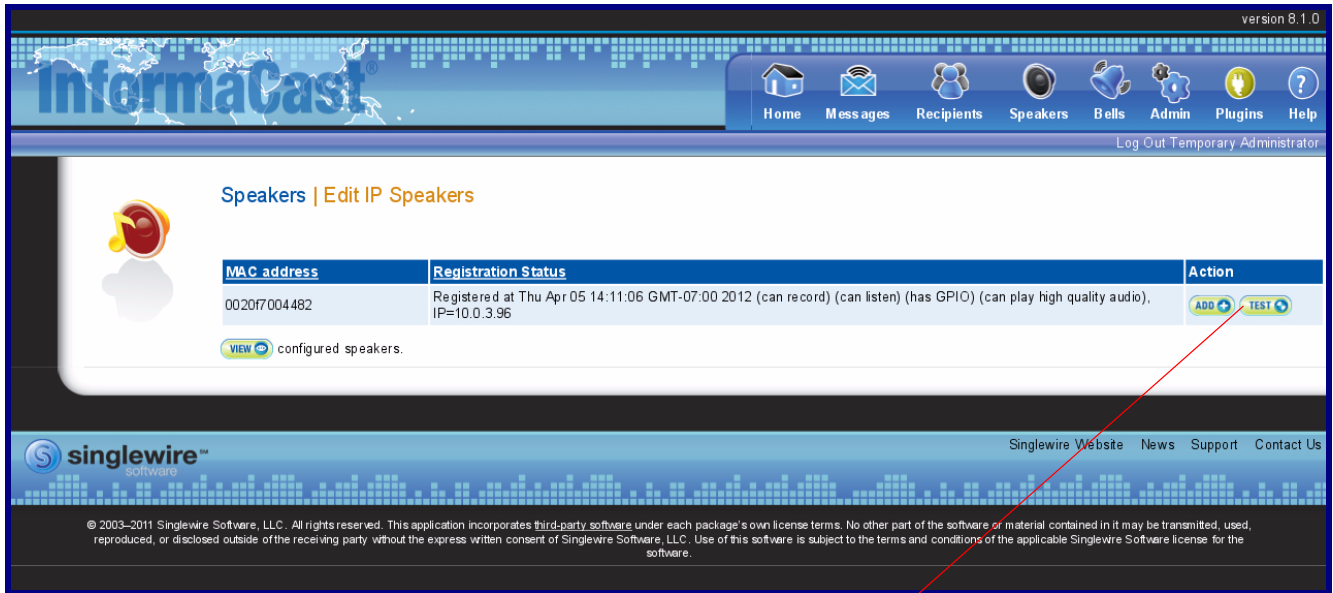

Test

4. On the **Test IP Speaker** page, Enter a number into the **Test duration** field.
5. Click **Test**.
6. You will hear a tone from the speaker being testing.
7. After the test, click **Cancel** to return to the **IP Configuration** page.

**Figure 2-39. Test IP Speaker Page**



Test duration

View Speaker's Status Page

Cancel

Test

8. On the **IP Speaker Configuration** page, Click **Add** to add a speaker to the InformaCast server.

**Figure 2-40. IP Configuration Page**

The screenshot shows the InformaCast web interface for IP speaker configuration. At the top, there's a navigation bar with icons for Home, Messages, Recipients, Speakers, Bells, Admin, Plugins, and Help. The main content area is titled 'Speakers | Edit IP Speakers' and includes a notification: 'InformaCast has detected new IP Speakers on the network.' Below this is a filter section and a table of 6 IP speakers. A red arrow points from the 'Add' button in the top right of the table to the 'Add' button in the footer of the page.

Name	Description and Status	Dial Code	Vol	MAC address	Action
<input type="checkbox"/> Christina's Clock	CyberData Clock/Speaker kit Status: <b>Not registered</b>		10	0020f7009b7b	<input type="button" value="EDIT"/> <input type="button" value="DELETE"/>
<input type="checkbox"/> ClockFixer	ClockFixer Status: <b>Not registered</b>	8675309	10	0020f7004597	<input type="button" value="EDIT"/> <input type="button" value="DELETE"/>
<input type="checkbox"/> Desktop Notify System	Status: <b>Not registered</b>		10	00137229f60d	<input type="button" value="EDIT"/> <input type="button" value="DELETE"/>
<input type="checkbox"/> jkyg	jhg Status: <b>Not registered</b>	41354	10	0020f700d8f6	<input type="button" value="EDIT"/> <input type="button" value="DELETE"/>
<input type="checkbox"/> rma test	testA Status: <b>Not registered</b>		10	0020f700f0ba	<input type="button" value="EDIT"/> <input type="button" value="DELETE"/>
<input type="checkbox"/> Talkback Test	Status: <b>Registration expired</b> , last seen at Wed Apr 04 15:50:12 GMT-07:00 2012 (can record) (can listen) (has GPIO) (can play high quality audio), IP=10.10.0.137	155	5	0020f700f0c4	<input type="button" value="EDIT"/> <input type="button" value="DELETE"/>

Add

9. On the **Add IP Speaker** page, Fill out appropriate fields and click **Add**.

**Figure 2-41. Add IP Speaker Page**

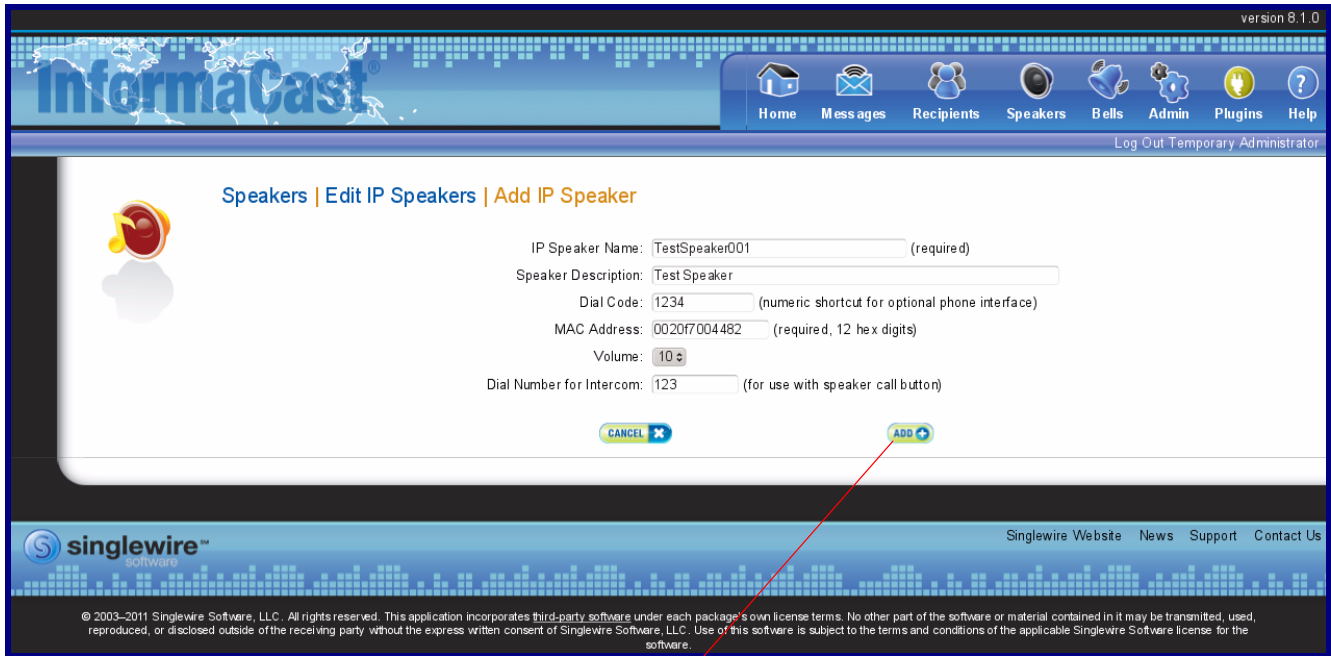

Add



Your speaker is now registered to the InformaCast server. You now can configure this device as part of the InformaCast system setup as required.

# Appendix A: Mounting the Speaker

## A.1 Mount the Speaker

Before you mount the speaker, make sure that you have received all the parts for each speaker. Refer to [Table A-1](#) and [Table A-2](#).

**Table A-1. Drop Ceiling Mounting Components (Part of the Accessory Kit)**

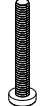
Quantity	Part Name	Illustration
3	#8 Nylon Thumb Nuts	
3	#8 Fender Washers	
3	8-32 x 1 1/4" Mounting Screws	

**Table A-2. Drywall Mounting Components (Part of the Accessory Kit)**

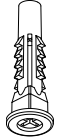
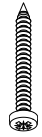
Quantity	Part Name	Illustration
3	Plastic Ribbed Anchors	
3	#8 Sheet Metal Screws	

To mount the speaker:

1. Use the **TEMPLATE** to cut the speaker hole and prepare holes for the screws (**Figure A-1**). This template is located on the back page of the *Installation Quick Reference Guide* that is delivered with each speaker.

**Figure A-1. Speaker Mounting**

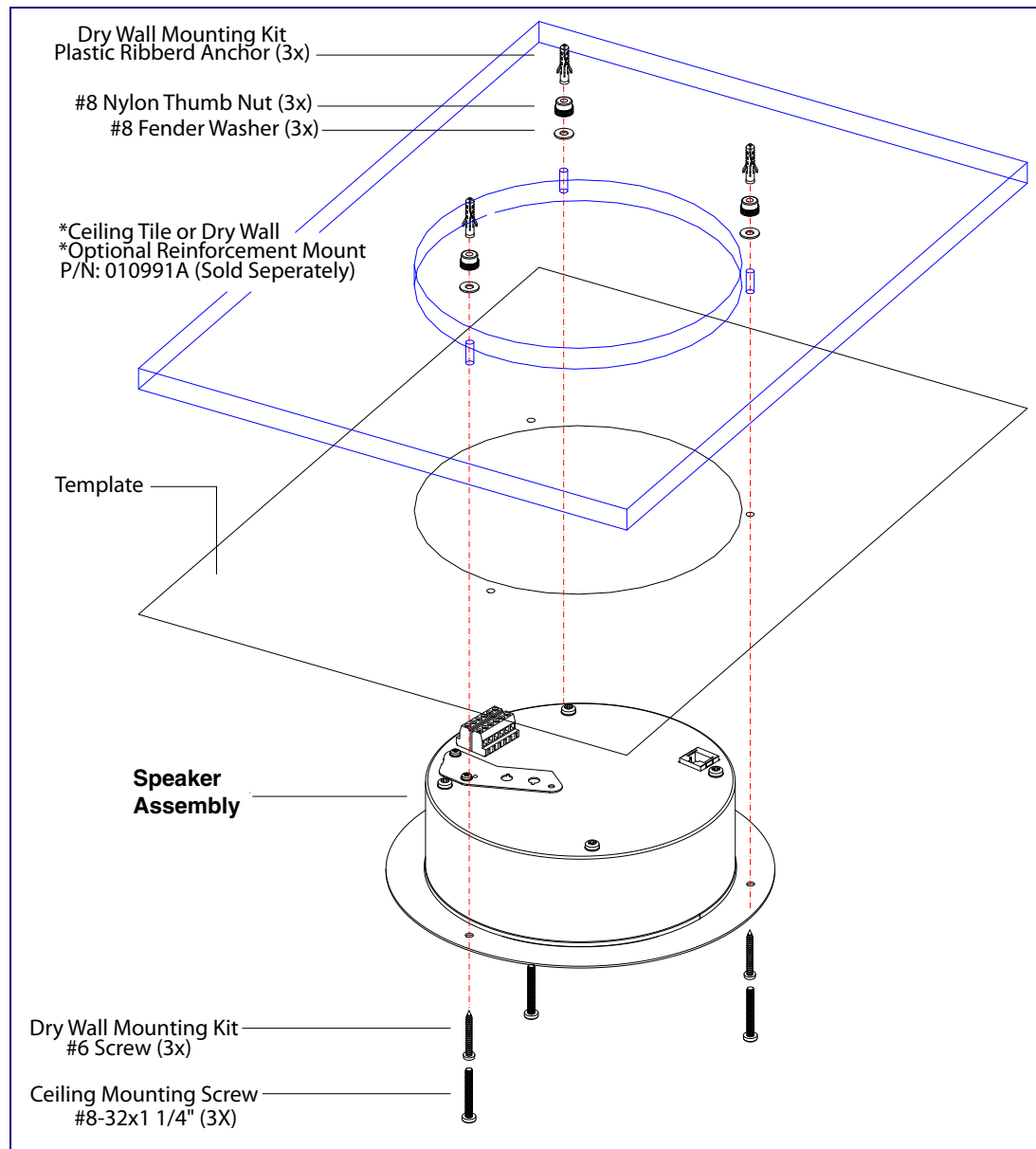

2. Plug the Ethernet cable into the Speaker Assembly. [Section 2.2.3, "Confirm that the Speaker is Operational and Linked to the Network"](#) explains how the **Link** and **Status** LEDs work.
3. At this point:
  - For *drop ceiling mounting*, position the **SPEAKER ASSEMBLY** in the ceiling so that its screw holes align with those you prepared.
  - For *drywall mounting*, place the three **PLASTIC RIBBED ANCHORS** in the holes you prepared, and position the **SPEAKER ASSEMBLY** over them, aligning the screw holes in the assembly with the anchors.
4. To fasten the speaker:
  - For *drop ceiling mounting*, use the three **8-32 x 1 1/4" MOUNTING SCREWS, #8 NYLON THUMB NUTS**, and **#8 FENDER WASHERS** to secure the speaker.

**Note** For weak ceiling tile, CyberData offers a reinforcing mount (CyberData part number 010991).

- For *drywall mounting*, use the three **#8 SHEET METAL SCREWS** to secure the speaker.

# Appendix B: Troubleshooting/Technical Support

---

## B.1 Frequently Asked Questions (FAQ)

To see a list of frequently asked questions for your product, click on the **FAQs** tab at the following webpage:

<http://www.cyberdata.net/voip/011399/>

---

## B.2 Documentation

The documentation for this product is released in an English language version only.

To download PDF copies of CyberData product documentation, click on the **Downloads** tab at the following webpage:

<http://www.cyberdata.net/voip/011399/>



---

## B.3 Contact Information

Contact            CyberData Corporation  
                      3 Justin Court  
                      Monterey, CA 93940 USA  
                      [www.CyberData.net](http://www.CyberData.net)  
                      Phone: 800-CYBERDATA (800-292-3732)  
                      Fax: 831-373-4193

Sales                Sales 831-373-2601, Extension 334

Technical          The fastest way to get technical support for your VoIP product is to submit a VoIP Technical  
Support            Support form at the following website:

<http://support.cyberdata.net/>

The Support Form initiates a ticket which CyberData uses for tracking customer requests. Most importantly, the Support Form tells us which PBX system and software version that you are using, the make and model of the switch, and other important information. This information is essential for troubleshooting. Please also include as much detail as possible in the **Comments** section of the Support Form.

Phone: (831) 373-2601, Extension 333

---

## B.4 Warranty and RMA Information

The most recent warranty and RMA information is available at the following website address:

<http://support.cyberdata.net/>

# Index

---

## Symbols

#8 fender washers 109, 111  
 #8 nylon thumb nuts 109, 111  
 #8 sheet metal screws 109, 111

## Numerics

8-32 x 1 1/4" mounting screws 109, 111

## A

activate relay (door sensor) 71  
 address, configuration login 38  
 adjusting volume 33  
 ambient operating temperature 5  
 analog speaker  
   analog volume control needs to be disabled 28  
 announcing a speaker's IP address 31, 33  
 audio configuration 73  
   night ring tone parameter 75  
 audio configuration page 73  
 audio files, user-created 76  
 audio output 5  
 audio sensitivity 5  
 audio test 31, 33  
 autoprovision at time (HHMMSS) 85  
 autoprovision when idle (in minutes > 10) 85  
 autoprovisioning 86  
   download template button 86  
 autoprovisioning autoupdate (in minutes) 85  
 autoprovisioning configuration 84, 85  
 autoprovisioning filename 85  
 autoprovisioning server (IP Address) 85

## B

backup SIP server 1 57  
 backup SIP server 2 57  
 backup SIP servers, SIP server  
   backups 57  
 blink button LED on monitor call 45  
 boost (volume) 44

## C

changing  
   the web access password 42  
 Chrome (web browser) 3  
 Cisco SRST 57  
 command interface 99  
 commands 99  
 configurable parameters 44, 53, 57  
 configuration  
   audio 73  
   default IP settings 34  
   device 22  
   door sensor 69  
   intrusion sensor 69  
   network 52  
   SIP 55  
 configuration home page 38  
 configuration page  
   configurable parameters 44, 53  
 confirming IP address 31, 33  
 contact information 113  
 contact information for CyberData 113  
 current network settings 53  
 CyberData contact information 113  
 CyberData support limited to IP endpoint functionality 103

## D

default  
   gateway 22, 34  
   IP address 22, 34  
   subnet mask 22, 34  
   username and password 22, 34  
   web login username and password 38  
 default gateway 22, 34, 53  
 default IP settings 34  
 default login address 38  
 device configuration 22, 42  
   device configuration parameters 85  
   the device configuration page 84  
 device configuration page 42  
 device configuration parameters 44  
 device configuration password  
   changing for web configuration access 42  
 dial out extension (door sensor) 71  
 dial out extension strings 62  
 dial-out extension strings 64  
 dimensions 5, 7  
 disable volume control dial 44

discovery utility program 38  
 DNS server 53  
 door sensor 69
 

- activate relay 71
- dial out extension 71
- door sensor normally closed 71
- play audio locally 71

 download autoprovisioning template button 86  
 drop ceiling mounting of speaker 111  
 drywall mounting of speaker 111  
 DTMF tones 62, 64  
 DTMF tones (using rfc2833) 62

## E

enable night ring events 79  
 Ethernet cable 111  
 ethernet port baud rate 5  
 event configuration
 

- enable night ring events 79

 expiration time for SIP server lease 58, 60  
 export settings 41

## F

factory default settings
 

- how to set 33

 features 3  
 Firefox (web browser) 3  
 firmware
 

- where to get the latest firmware 96

## G

get autoprovisioning template 86  
 GMT table 50  
 GMT time 50

## H

home page 38  
 http POST command 99

## I

identifier names (PST, EDT, IST, MUT) 50  
 identifying the speaker (when using InformaCast 4.0) 103

identifying your product 1  
 illustration of speaker mounting process 109  
 import settings 41  
 import/export settings 41  
 InformaCast
 

- Add IP Speaker Page 108
- IP Speaker Configuration page 104
- Test IP Speaker Page 106
- testing and identifying a Singlewire-enabled ceiling speaker 103

 InformaCast needs to be 4.0 or higher 2  
 installation, typical speaker system 2  
 Internet Explorer (web browser) 3  
 intrusion sensor 69  
 IP address 22, 34, 53  
 IP addressing
 

- default
  - IP addressing setting 22, 34

## L

lease, SIP server expiration time 58, 60  
 lengthy pages 68  
 link LED 111  
 local SIP port 58  
 log in address 38

## M

MGROUP
 

- MGROUP Name 67

 monitor authenticate ID 58  
 monitor authenticate password 58  
 monitor user ID 58  
 mounting a speaker 109  
 Mozilla Firefox (web browser) 3  
 multicast configuration 65, 73  
 Multicast IP Address 67

## N

navigation (web page) 35  
 navigation table 35  
 network configuration 52  
 network link activity, verifying 30  
 nightring tones 68  
 Nightringer 95  
 nightringer settings 60  
 NTP server 44

## O

overview 1

## P

pages (lengthy) 68

parts

- #8 fender washers 109
- #8 nylon thumb nuts 109
- #8 sheet metal screws 109
- 8-32 x 1 1/4" mounting screws 109
- plastic ribbed anchors 109

password

- for SIP server login 57
- login 38
- restoring the default 22, 34

plastic ribbed anchors 109, 111

play audio locally (door sensor) 71

point-to-point configuration 63

polycom default channel 67

polycom emergency channel 67

polycom priority channel 67

port

- local SIP 58
- remote SIP 58

posix timezone string

- timezone string 44

POST command 99

power input (J1) 5

power requirement 5

power, connecting to speaker 23

priority

- assigning 68

product

- mounting 109
- parts list 21

product features 3

product overview 1

- product features 3
- product specifications 5
- revision history 3

product specifications 5

## R

reboot 97, 98

remote SIP port 58

Reset Test Function Management (RTFM) button 31, 33

restoring the factory default settings 33

revision history 3

ringtones 68

lengthy pages 68

rport discovery setting, disabling 58

RTFM button 31, 33

## S

Safari (web browser) 3

sales 113

sensor

- sensor normally closed 71

- sensor timeout 71

sensor setup page 70

sensor setup parameters 69

sensors 71

server address, SIP 57

service 113

set time with external NTP server on boot 44

Singlewire Informacast Server Web Interface 103

Singlewire-enabled Ceiling Speaker

- how to identify 1

Singlewire-enabled Speaker

- installation 2

SIP

- enable SIP operation 57

- local SIP port 58

- user ID 57

SIP configuration 55

SIP configuration parameters

- outbound proxy 58, 60
- registration and expiration, SIP server lease 58, 60
- unregister on reboot 58
- user ID, SIP 57

SIP registration 57

SIP remote SIP port 58

SIP server 57

- password for login 57

- unregister from 58

- user ID for login 57

SIP server configuration 57

SIP volume 44

SRST 57

status LED 111

subnet mask 22, 34, 53

## T

tech support 113

technical support, contact information 113

template for speaker and screw holes 110

testing audio 31, 33

testing the speaker (when using InformaCast 4.0) 103

time zone string examples 50

---

typical system installation 2

## U

user ID  
    for SIP server login 57  
username  
    changing for web configuration access 42  
    default for web configuration access 38  
    restoring the default 22, 34

## V

verifying  
    network link and activity 30  
    power on to speaker 30  
VLAN ID 53  
VLAN Priority 53  
VLAN tagging support 53  
VLAN tags 53  
VoIP speaker assembly 111  
volume  
    multicast volume 44  
    ring volume 44  
    sensor volume 44  
    SIP volume 44  
volume boost 44  
volume control dial  
    disable 44  
volume, adjusting 33

## W

warranty policy at CyberData 113  
web access password 22, 34  
web access username 22, 34  
web configuration log in address 38  
web page  
    navigation 35  
web page navigation 35  
weight 5  
wget, free unix utility 99