



SIP Loudspeaker Amplifier (PoE) Operations Guide



Part #011405
Document Part #931236H
for Firmware Version 11.6.4

CyberData Corporation
3 Justin Court
Monterey, CA 93940
(831) 373-2601

Operations Guide 931236H
Part # 011405

COPYRIGHT NOTICE:

© 2018, CyberData Corporation, ALL RIGHTS RESERVED.

This manual and related materials are the copyrighted property of CyberData Corporation. No part of this manual or related materials may be reproduced or transmitted, in any form or by any means (except for internal use by licensed customers), without prior express written permission of CyberData Corporation. This manual, and the products, software, firmware, and/or hardware described in this manual are the property of CyberData Corporation, provided under the terms of an agreement between CyberData Corporation and recipient of this manual, and their use is subject to that agreement and its terms.

DISCLAIMER: Except as expressly and specifically stated in a written agreement executed by CyberData Corporation, CyberData Corporation makes no representation or warranty, express or implied, including any warranty or merchantability or fitness for any purpose, with respect to this manual or the products, software, firmware, and/or hardware described herein, and CyberData Corporation assumes no liability for damages or claims resulting from any use of this manual or such products, software, firmware, and/or hardware. CyberData Corporation reserves the right to make changes, without notice, to this manual and to any such product, software, firmware, and/or hardware.

OPEN SOURCE STATEMENT: Certain software components included in CyberData products are subject to the GNU General Public License (GPL) and Lesser GNU General Public License (LGPL) “open source” or “free software” licenses. Some of this Open Source Software may be owned by third parties. Open Source Software is not subject to the terms and conditions of the CyberData COPYRIGHT NOTICE or software licenses. Your right to copy, modify, and distribute any Open Source Software is determined by the terms of the GPL, LGPL, or third party, according to who licenses that software.

Software or firmware developed by CyberData that is unrelated to Open Source Software is copyrighted by CyberData, subject to the terms of CyberData licenses, and may not be copied, modified, reverse-engineered, or otherwise altered without explicit written permission from CyberData Corporation.

TRADEMARK NOTICE: CyberData Corporation and the CyberData Corporation logos are trademarks of CyberData Corporation. Other product names, trademarks, and service marks may be the trademarks or registered trademarks of their respective owners.



Technical Support

The fastest way to get technical support for your VoIP product is to submit a VoIP Technical Support form at the following website:

<http://support.cyberdata.net/>

Phone: (831) 373-2601, Ext. 333

Email: support@cyberdata.net

Fax: (831) 373-4193

Company and product information is at www.cyberdata.net.

Revision Information

Revision 931236H, which corresponds to firmware version 11.6.4, was released on January 23, 2018, and has the following changes:



- Updates [Table 2-2, "Parts List"](#) and [Table A-1, "Wall Mounting Components \(Part of the Accessory Kit\)"](#) to update the following text:
 - (3) #8 Plastic Anchors
 - (3) #8 x 1-1/4" Pan Head Phillips Self-Tapping Screws

Browsers Supported

The following browsers have been tested against firmware version 6.5.0:

- Internet Explorer (version: 10)
- Firefox (also called Mozilla Firefox) (version: 23.0.1 and 25.0)
- Chrome (version: 29.0.1547.66 m)
- Safari (version: 5.1.7)

Pictorial Alert Icons

	<p>General Alert <i>This pictorial alert indicates a potentially hazardous situation. This alert will be followed by a hazard level heading and more specific information about the hazard.</i></p>
	<p>Ground <i>This pictorial alert indicates the Earth grounding connection point.</i></p>

Hazard Levels

Danger: Indicates an imminently hazardous situation which, if not avoided, will result in death or serious injury. This is limited to the most extreme situations.

Warning: Indicates a potentially hazardous situation which, if not avoided, could result in death or serious injury.



Caution: Indicates a potentially hazardous situation which, if not avoided, could result in minor or moderate injury. It may also alert users against unsafe practices.

Notice: Indicates a statement of company policy (that is, a safety policy or protection of property).

- The safety guidelines for the equipment in this manual do not purport to address all the safety issues of the equipment. It is the responsibility of the user to establish appropriate safety, ergonomic, and health practices and determine the applicability of regulatory limitations prior to use. Potential safety hazards are identified in this manual through the use of words Danger, Warning, and Caution, the specific hazard type, and pictorial alert icons.

Important Safety Instructions

1. Read these instructions.
2. Keep these instructions.
3. Heed all warnings.
4. Follow all instructions.
5. Do not use this apparatus near water.
6. Clean only with dry cloth.
7. Do not block any ventilation openings. Install in accordance with the manufacturer's instructions.
8. Do not install near any heat sources such as radiators, heat registers, stoves, or other apparatus (including amplifiers) that produce heat.
9. Do not defeat the safety purpose of the polarized or grounding-type plug. A polarized plug has two blades with one wider than the other. A grounding type plug has two blades and a third grounding prong. The wide blade or the third prong are provided for your safety. If the provided plug does not fit into your outlet, consult an electrician for replacement of the obsolete outlet.
10. Protect the power cord from being walked on or pinched particularly at plugs, convenience receptacles, and the point where they exit from the apparatus.
11. Only use attachments/accessories specified by the manufacturer.
12. Refer all servicing to qualified service personnel. Servicing is required when the apparatus has been damaged in any way, such as power-supply cord or plug is damaged, liquid has been spilled or objects have fallen into the apparatus, the apparatus has been exposed to rain or moisture, does not operate normally, or has been dropped.
13. Prior to installation, consult local building and electrical code requirements.
- 14. WARNING: The SIP Loudspeaker Amplifier (PoE) enclosure is not rated for any AC voltages!**

 <p>GENERAL ALERT</p>	<p>Warning</p> <p><i>Electrical Hazard:</i> This product should be installed by a licensed electrician according to all local electrical and building codes.</p>
 <p>GENERAL ALERT</p>	<p>Warning</p> <p><i>Electrical Hazard:</i> To prevent injury, this apparatus must be securely attached to the floor/wall in accordance with the installation instructions.</p>
 <p>GENERAL ALERT</p>	<p>Warning</p> <p>The PoE connector is intended for intra-building connections only and does not route to the outside plant.</p>

Abbreviations and Terms

Abbreviation or Term	Definition
A-law	A standard companding algorithm, used in European digital communications systems to optimize, i.e., modify, the dynamic range of an analog signal for digitizing.
AVP	Audio Video Profile
Cat 5	TIA/EIA-568-B Category 5
DHCP	Dynamic Host Configuration Protocol
LAN	Local Area Network
LED	Light Emitting Diode
Mbps	Megabits per Second.
NTP	Network Time Protocol
PBX	Private Branch Exchange
PoE	Power over Ethernet (as per IEEE 802.3af standard)
RTFM	Reset Test Function Management
SIP	Session Initiated Protocol
u-law	A companding algorithm, primarily used in the digital telecommunication
UC	Unified Communications
VoIP	Voice over Internet Protocol

Chapter 1 Product Overview	1
1.1 How to Identify This Product	1
1.2 Typical System Installation	2
1.3 Product Features	3
1.4 Supported Protocols	4
1.5 Supported SIP Servers	4
1.6 Specifications	5
1.7 Typical Coverage	6
1.8 Typical Warehouse Paging Setup	6
1.9 Compliance	7
1.9.1 CE Testing	7
1.9.2 FCC Statement	7
Chapter 2 Installing the SIP Loudspeaker Amplifier (PoE)	8
2.1 Parts List	8
2.2 SIP Loudspeaker Amplifier (PoE) Setup	9
2.2.1 SIP Loudspeaker Amplifier (PoE) Components	10
2.2.2 NEMA Box Components of the SIP Loudspeaker Amplifier (PoE)	11
2.2.3 Connecting the SIP Loudspeaker Amplifier (PoE)	12
2.2.4 SIP Loudspeaker Amplifier (PoE) System Installation and Connection Options	15
2.2.5 Strobe Connections Behind the Port Cover	17
2.2.6 Connecting the Strobe	18
2.2.7 SIP Loudspeaker Amplifier (PoE) Jumpers	20
2.2.8 Ethernet Connection	20
2.2.9 Loudspeaker Type	21
2.2.10 Cabling/Wiring	21
2.2.11 Confirm Operation	22
2.2.12 Confirm the IP Address and Test the Audio	23
2.2.13 Adjust the Volume	24
2.3.1 Factory Default Settings	27
2.3.2 SIP Loudspeaker Amplifier (PoE) Web Page Navigation	28
2.3.3 Using the Toggle Help Button	29
2.3.4 Using the Toggle Help Button	31
2.3.5 Log in to the Home Page	33
2.3.6 Configure the Device	37
2.3.7 Configure the Network Parameters	44
2.3.8 Configure the SIP (Session Initiation Protocol) Parameters	47
2.3.9 Configure the Multicast Parameters	56
2.3.10 Configure the Sensor Page Parameters	60
2.3.11 Configure the Audiofiles Page Parameters	64
2.3.12 Configure the Events Parameters	71
2.3.13 Configure the Autoprovisioning Parameters	77
2.4.1 Downloading the Firmware	89
2.4.2 Reboot the Device	91
2.5.1 Command Interface Post Commands	92
Appendix A Mounting the Amplifier	96
A.1 Mount the Amplifier	96
Appendix B Setting up a TFTP Server	98
B.1 Set up a TFTP Server	98
B.1.1 In a LINUX Environment	98
B.1.2 In a Windows Environment	98
Appendix C Troubleshooting/Technical Support	99
C.1 Frequently Asked Questions (FAQ)	99
C.2 Documentation	99
C.3 Contact Information	100
C.4 Warranty and RMA Information	100

1 Product Overview

1.1 How to Identify This Product

To identify the SIP Loudspeaker Amplifier (PoE), look for a model number label similar to the one shown in [Figure 1-1](#). Confirm the following:

- The model number on the label should be **011405**.

Figure 1-1. Model Number Label

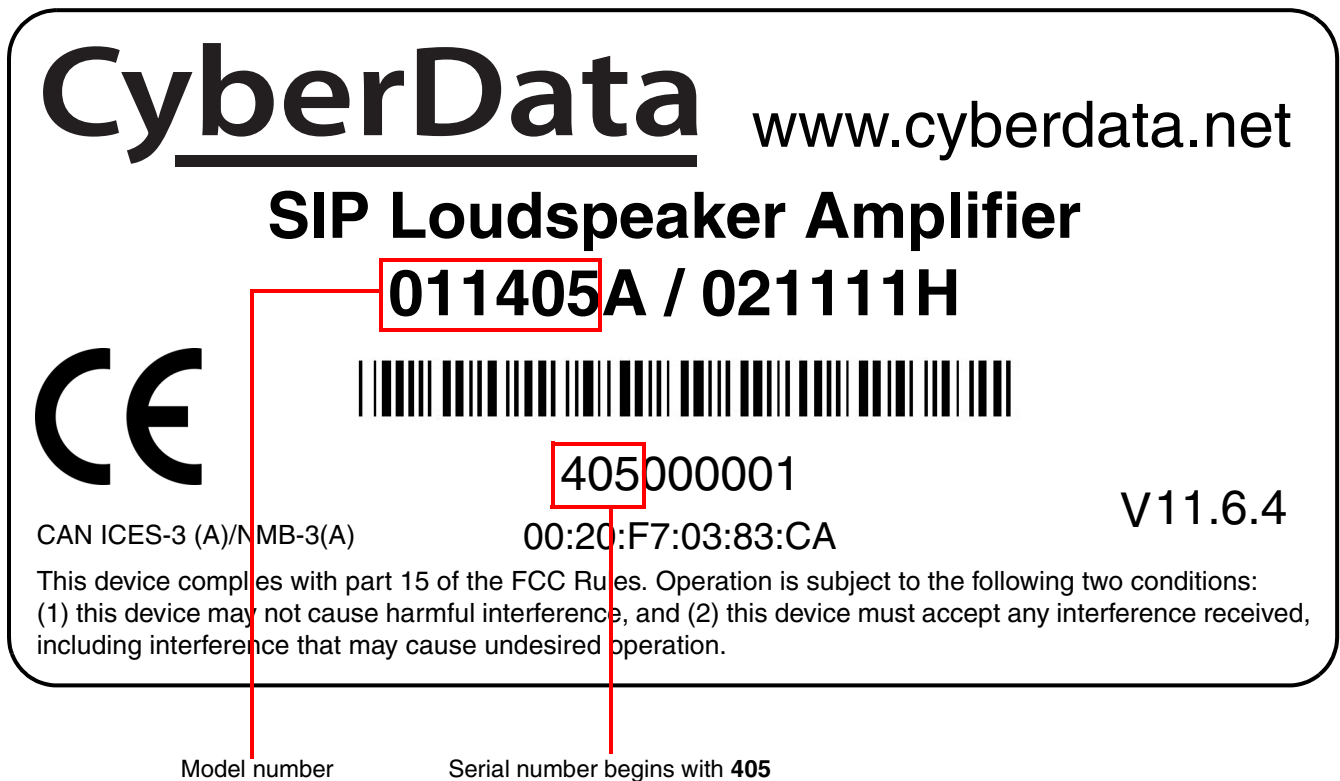

1.2 Typical System Installation

Figure 1-2 illustrates how the SIP Loudspeaker Amplifier (PoE) is normally installed as part of a public address system.

Figure 1-2. Typical Installation

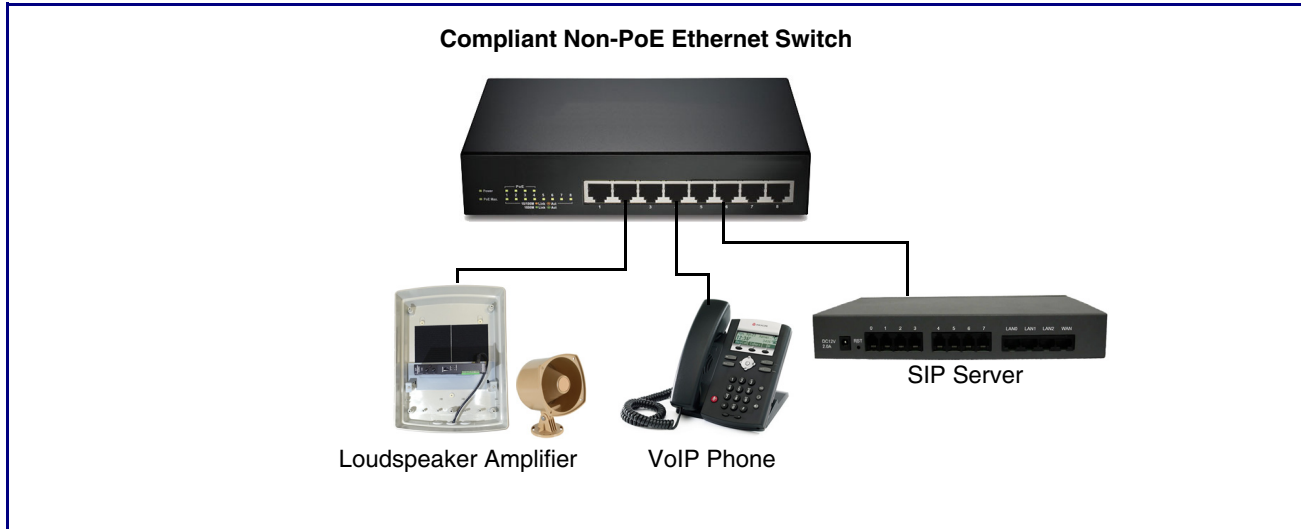

1.3 Product Features

- SIP-enhanced interoperability for hosted environments
- Support for security code access for SIP paging
- Page to Polycom phones
- Autoprovisioning via HTTPS
- HTTPS web based configuration
- Support for G.722 codecs
- 802.11q VLAN tagging
- Configurable sense input for use with fault detection
- Configurable event generation for device health and status monitoring
- Optional direct connect RGB strobe kit connection
- 9 user-uploadable page messages
- Features
- Packaged in a NEMA 3/3x (IP55)-rated enclosure
- Dual-speed ethernet 10/100 Mbps
- Web-based configuration
- PoE 802.3at and 802.3af-enabled Line-in for background music
- Line-out connector
- DTMF controlled relay
- Direct 8 Ohm speaker drive
- User-uploadable tones and messages
- Digital and manual volume control
- Second SIP endpoint "Night Ringer"
- Autoprovisioning
- Auto-call voice message from input port sense Can support two horns
- HTTP Command Interface
- 10 channel prioritized Multicast ports
- Built-in diagnostics
- Delayed page support
- Cisco SRST

1.4 Supported Protocols

The SIP Loudspeaker Amplifier (PoE) supports:

- SIP
- Multicast
- HTTP and HTTPS web-based configuration

Provides an intuitive user interface for easy system configuration and verification of SIP Loudspeaker Amplifier (PoE) operations.

- DHCP Client

Dynamically assigns IP addresses in addition to the option to use static addressing.

- TFTP Client

Facilitates hosting for the configuration file for Autoprovisioning.

- RTP
- RTP/AVP - Audio Video Profile
- SPEEX
- Audio Encodings

PCMU (G.711 mu-law)

PCMA (G.711 A-law)

G.722

Packet Time 20 ms

1.5 Supported SIP Servers

The following link contains information on how to configure the SIP Loudspeaker Amplifier (PoE) for the supported SIP servers:

<http://www.cyberdata.net/connecting-to-ip-pbx-servers/>

1.6 Specifications

Table 1-1. Specifications

Specifications	
Ethernet I/F	10/100 Mbps
Protocol	SIP RFC 3261 Compatible
Power Input	PoE 802.3at or 802.3af
Audio Output	802.3af - SPL 114 dB @ 1 meter ^a 802.3at - SPL 117 dB @ 1 meter ^a
Line In:	
Input Signal Amplitudes	2.0 VPP maximum
Input Impedance	10k Ohm
Line Out:	
Output Signal Amplitudes	2.0 VPP maximum
Output Level	+2dBm nominal
Total Harmonic Distortion	0.5% maximum
Output Impedance	10k Ohm
Operating Range (with NEMA enclosure)	Temperature: -40° C to 55° C (-40° F to 131° F) Humidity: 5-95%, non-condensing Enclosure: NEMA3/3X (IP55 rated)
Storage Temperature	-40° C to 70° C (-40° F to 158° F)
Storage Altitude	Up to 15,000 ft. (4573 m)
Payload Types	G.711 a-law, G.711 u-law, and G.722
Dimensions ^b	10 in. [254 mm] Length 4 in. [101.6 mm] Width 14 in. [355.6 mm] Height
Boxed Weight	6.5 lbs. [2.95 kg]
Compliance	CE; EMC Directive – Class A EN 55032 & EN 55024, LV Safety Directive – EN 60950-1, RoHS Compliant, FCC; Part 15 Class A, Industry Canada; ICES-3 Class A, IEEE 802.3 Compliant
Part Number	011405
Loudspeaker Part Number	011068

a. When used with the 011068 Mini Horn.

b. Dimensions are measured from the perspective of the product being upright with the front of the product facing you.

1.7 Typical Coverage

With one horn attached to Paging Amplifier under standard 802.3af PoE power, coverage is up to 5,000 square feet. With two horns attached to the Paging Amplifier under 802.3at PoE (high power), coverage is up to 10,000 square feet depending on ambient background noise levels.

1.8 Typical Warehouse Paging Setup

Figure 1-3. Typical Warehouse Paging Setup

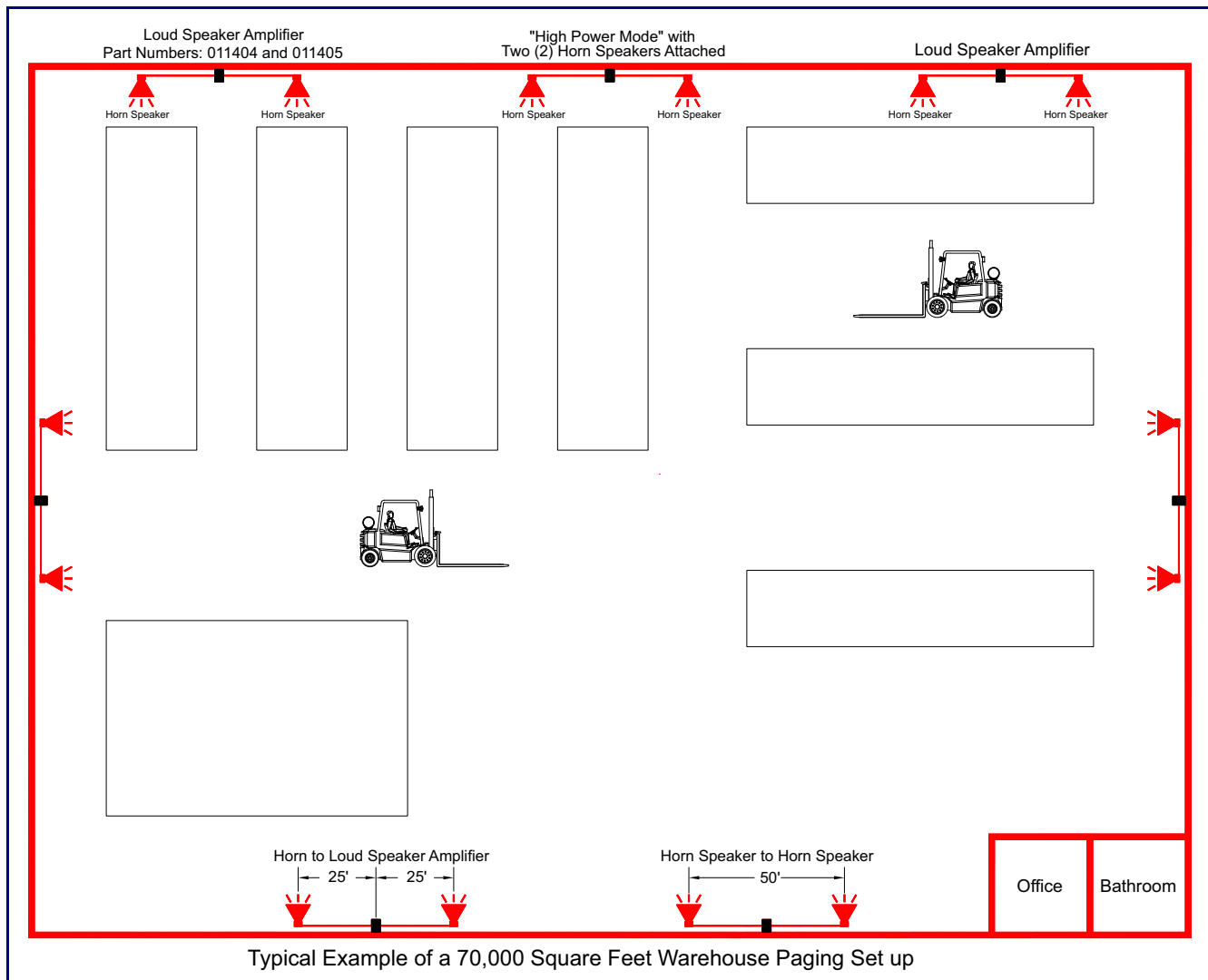

1.9 Compliance

1.9.1 CE Testing

CE testing has been performed according to EN ISO/IEC 17050 for Emissions, Immunity, and Safety.

Note You can download the Declaration of Conformity document from the **Downloads** tab of the product's webpage.

1.9.2 FCC Statement

This equipment has been tested and found to comply with the limits for a Class B digital device, pursuant to part 15 of the FCC Rules. These limits are designed to provide reasonable protection against harmful interference when the equipment is operated in a commercial environment. This equipment generates, uses, and can radiate radio frequency energy and, if not installed and used in accordance with the instruction manual, may cause harmful interference to radio communications. Operation of this equipment in a residential area is likely to cause harmful interference in which case the user will be required to correct the interference at his own expense.

2 Installing the SIP Loudspeaker Amplifier (PoE)

2.1 Parts List

Table 2-2 illustrates the parts for each SIP Loudspeaker Amplifier (PoE) and includes a kit for mounting.

Table 2-2. Parts List

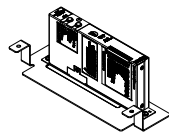
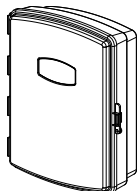
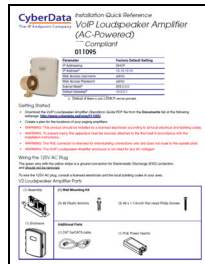
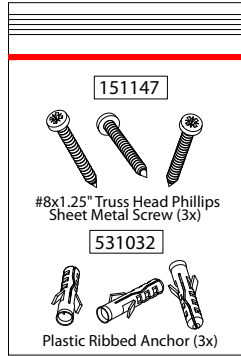
Quantity	Part Name	Illustration
1	SIP Loudspeaker Amplifier (PoE) Assembly	
1	Enclosure	
1	Installation Quick Reference Guide	
1	Mounting Accessory Kit which includes: (3) #8 Plastic Anchors (3) #8 x 1-1/4" Pan Head Phillips Self-Tapping Screws	

2.2 SIP Loudspeaker Amplifier (PoE) Setup

Set up and configure each SIP Loudspeaker Amplifier (PoE) *before* you mount it.

CyberData delivers each SIP Loudspeaker Amplifier (PoE) with the factory default values indicated in

Table 2-3:

Table 2-3. Factory Default Settings—Default of Network

Parameter	Factory Default Setting
IP Addressing	DHCP
IP Address ^a	10.10.10.10
Web Access Username	admin
Web Access Password	admin
Subnet Mask ^a	255.0.0.0
Default Gateway ^a	10.0.0.1

a. Default if there is not a DHCP server present.

2.2.1 SIP Loudspeaker Amplifier (PoE) Components

Figure 2-4 shows the components of the SIP Loudspeaker Amplifier (PoE).

Figure 2-4. SIP Loudspeaker Amplifier (PoE) Components

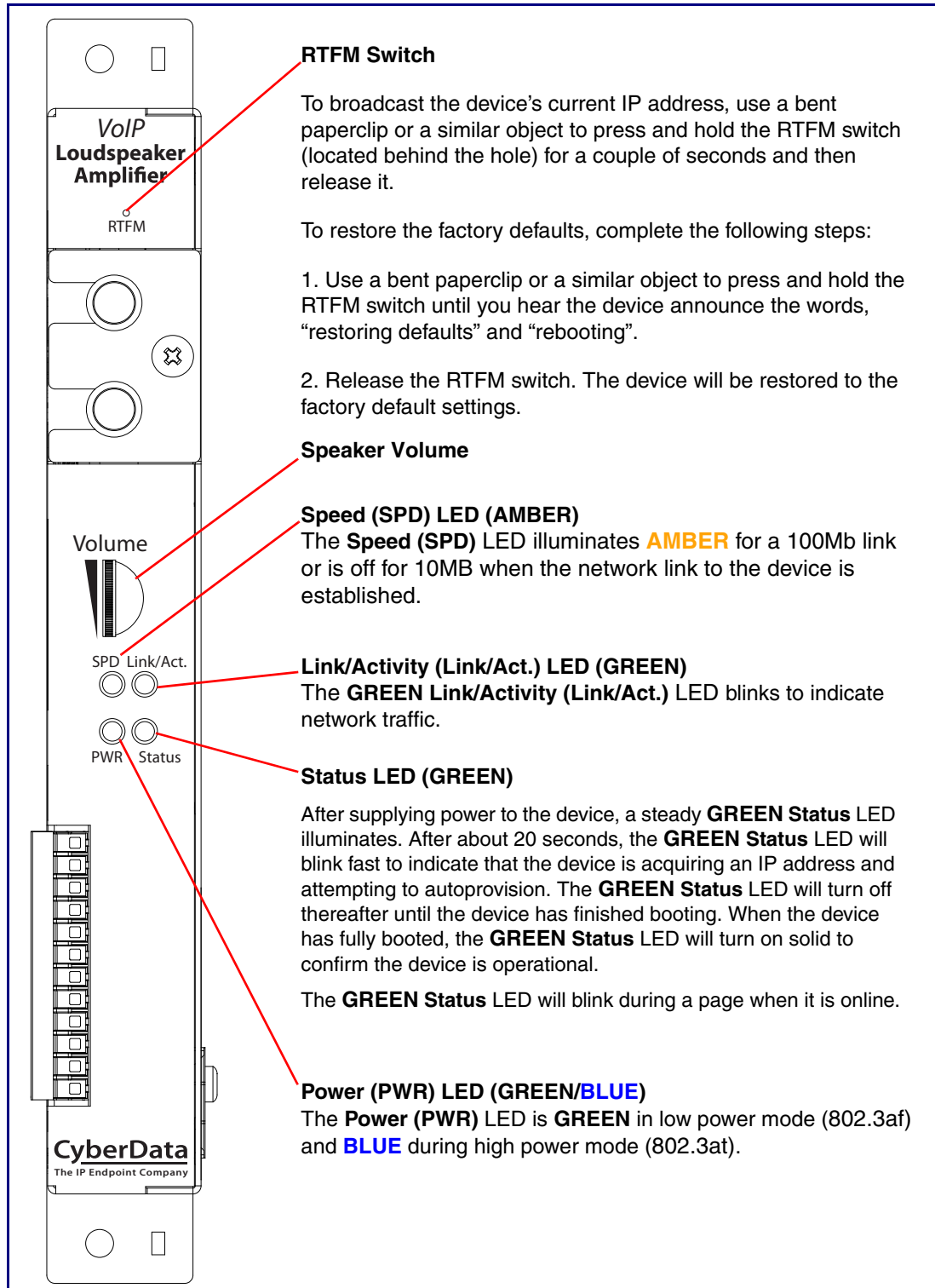

2.2.2 NEMA Box Components of the SIP Loudspeaker Amplifier (PoE)

Figure 2-5 shows all of the NEMA box components of the SIP Loudspeaker Amplifier (PoE).

Figure 2-5. Loudspeaker Amplifier Components—PoE

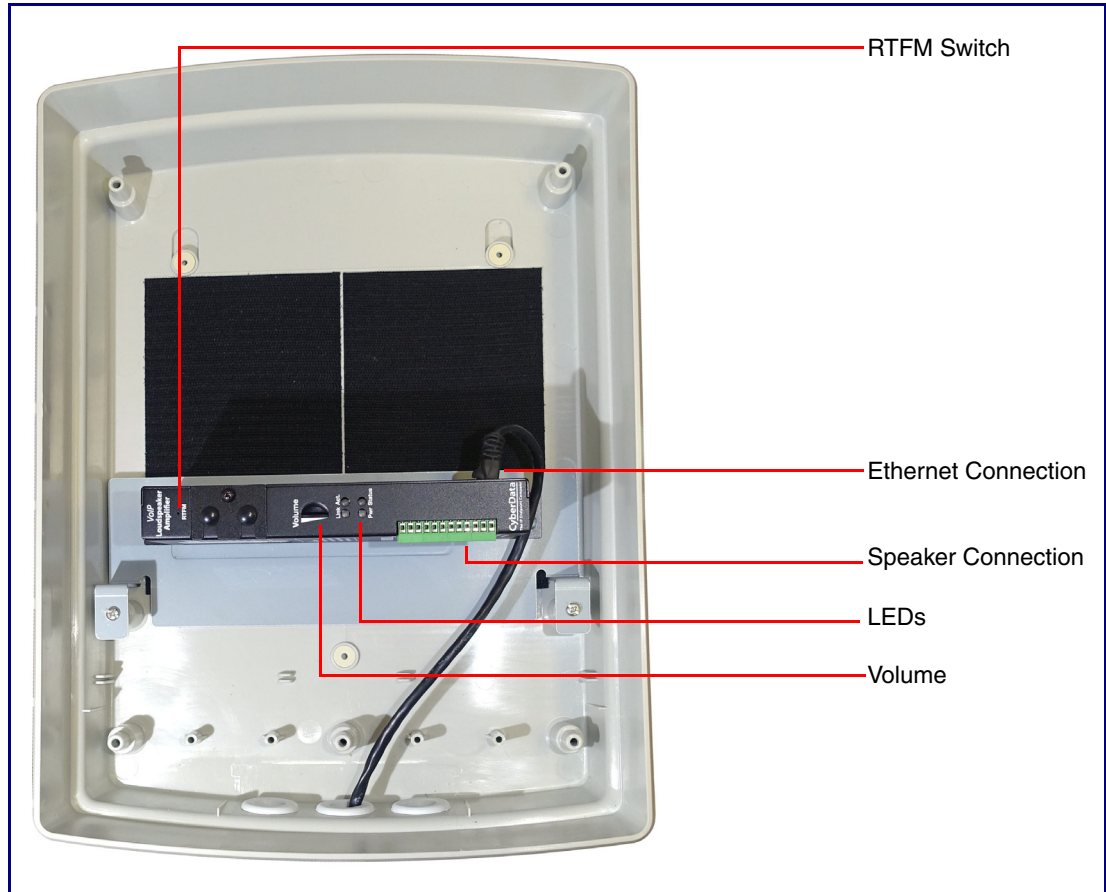

2.2.3 Connecting the SIP Loudspeaker Amplifier (PoE)

2.2.3.1 Using the Amplified Outputs

Low Power Mode (One Speaker) The following figure illustrate how to connect the SIP Loudspeaker Amplifier (PoE) and use the amplified outputs in low power mode to one speaker or horn.

Figure 2-6. Using the Amplified Outputs—Low Power Mode with One Speaker

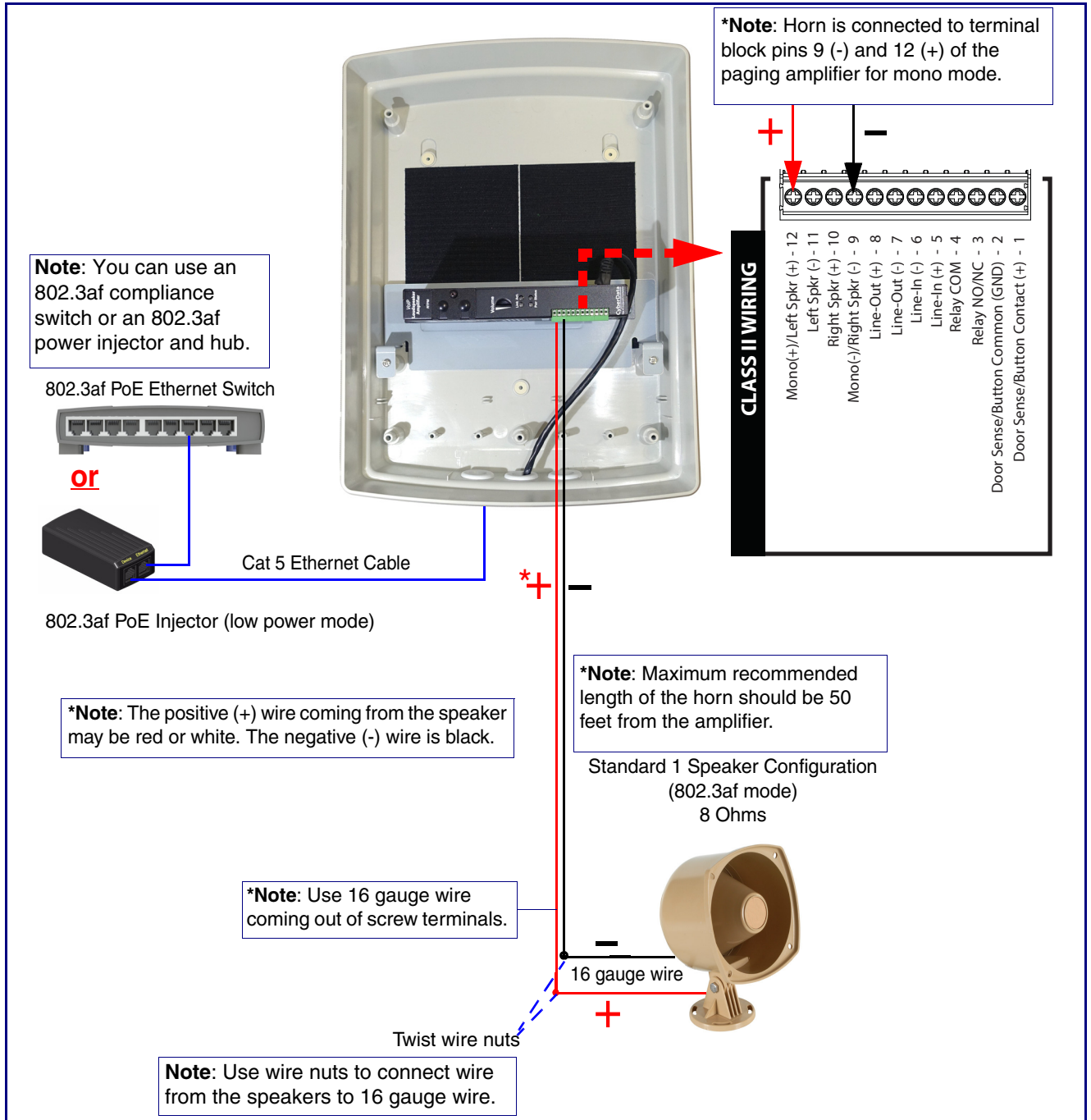

High Power Mode (One Speaker) The following figure illustrate how to connect the SIP Loudspeaker Amplifier (PoE) and use the amplified outputs in high power mode to one speaker or horn.

Figure 2-7. Using the Amplified Outputs—High Power Mode with One Speaker

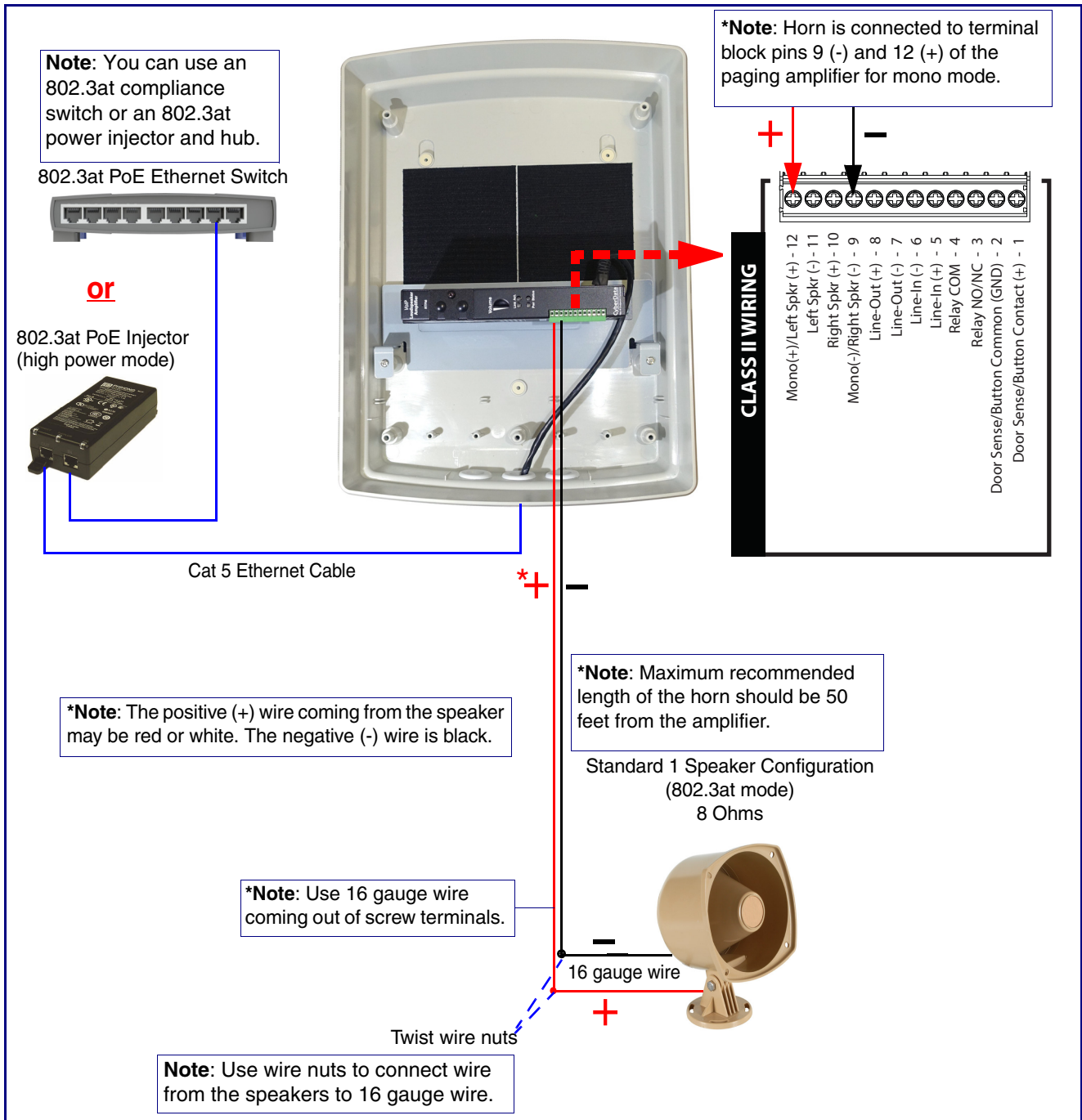

High Power Mode (Two Speakers) The following figure illustrate how to connect the SIP Loudspeaker Amplifier (PoE) and use the amplified outputs in high power mode to two speakers or horns.

Figure 2-8. Using the Amplified Outputs—High Power Mode with Two Speakers

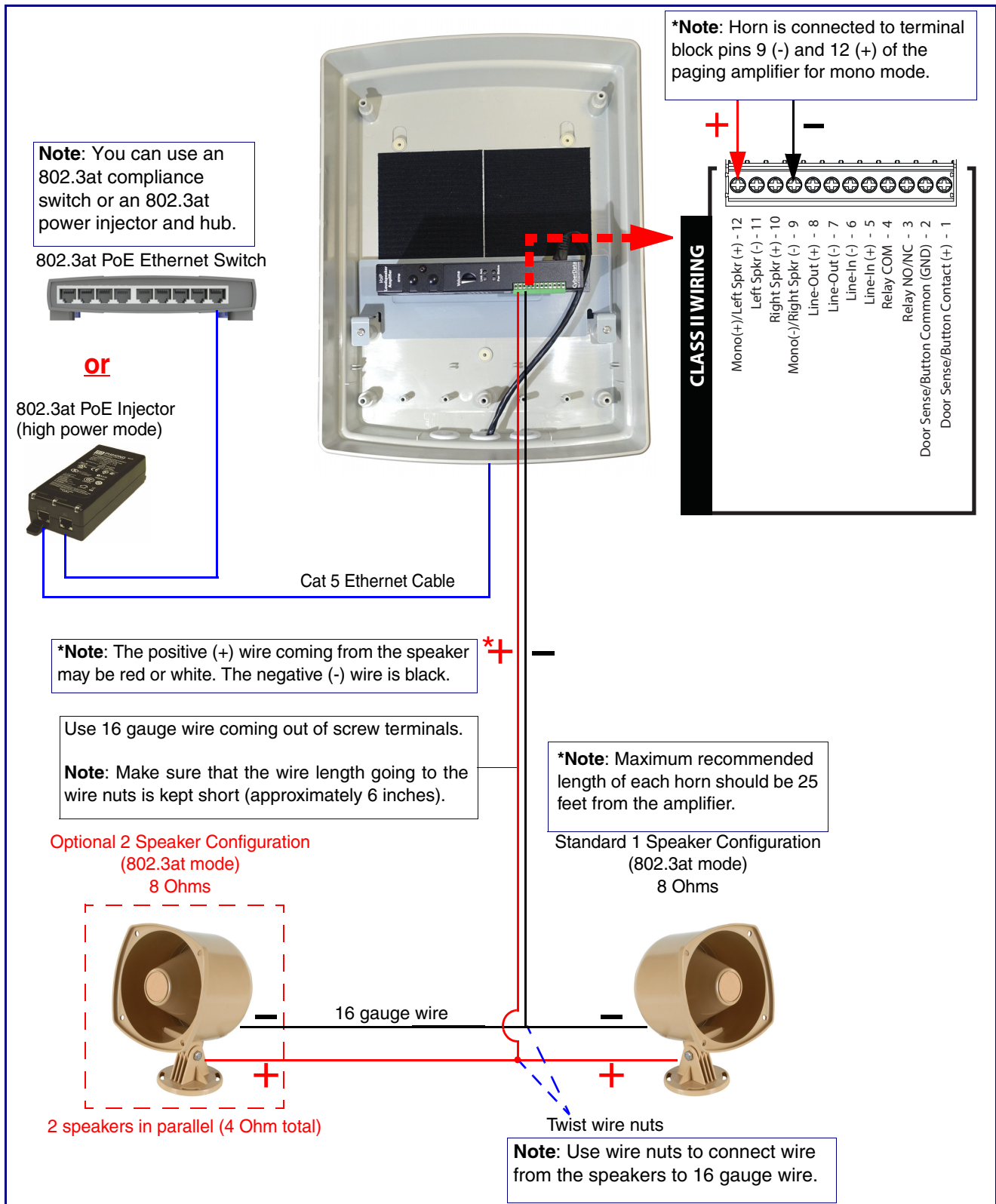

2.2.4 SIP Loudspeaker Amplifier (PoE) System Installation and Connection Options

The following figures show the connection options for the SIP Loudspeaker Amplifier (PoE).

Figure 2-9. SIP Loudspeaker Amplifier (PoE) Connections

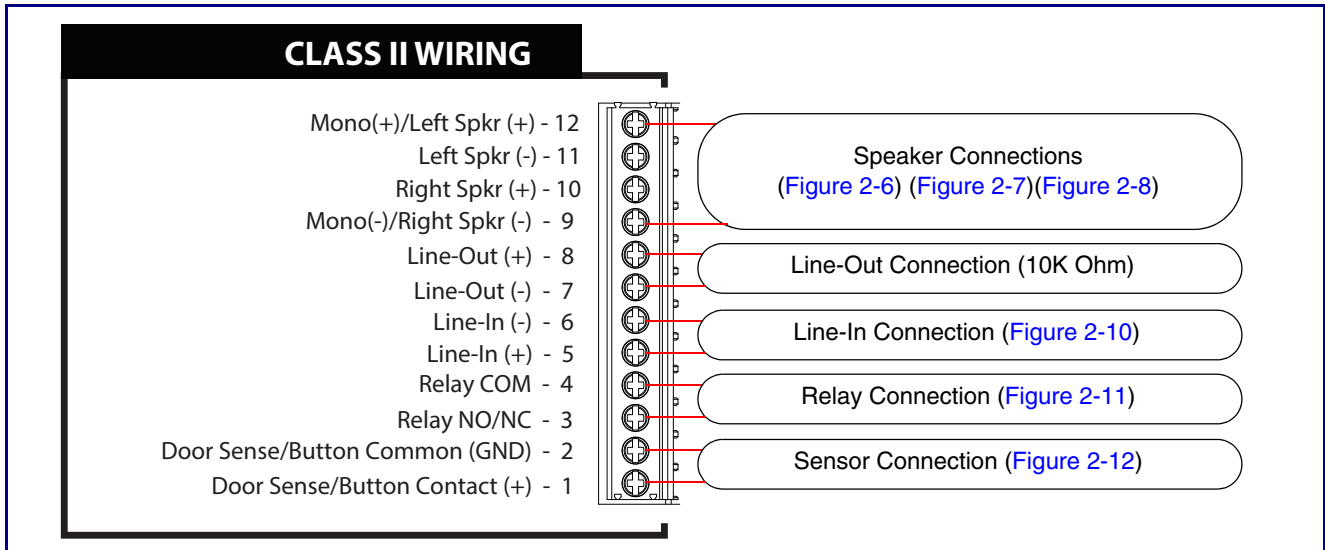

Figure 2-10. Line-In Connection

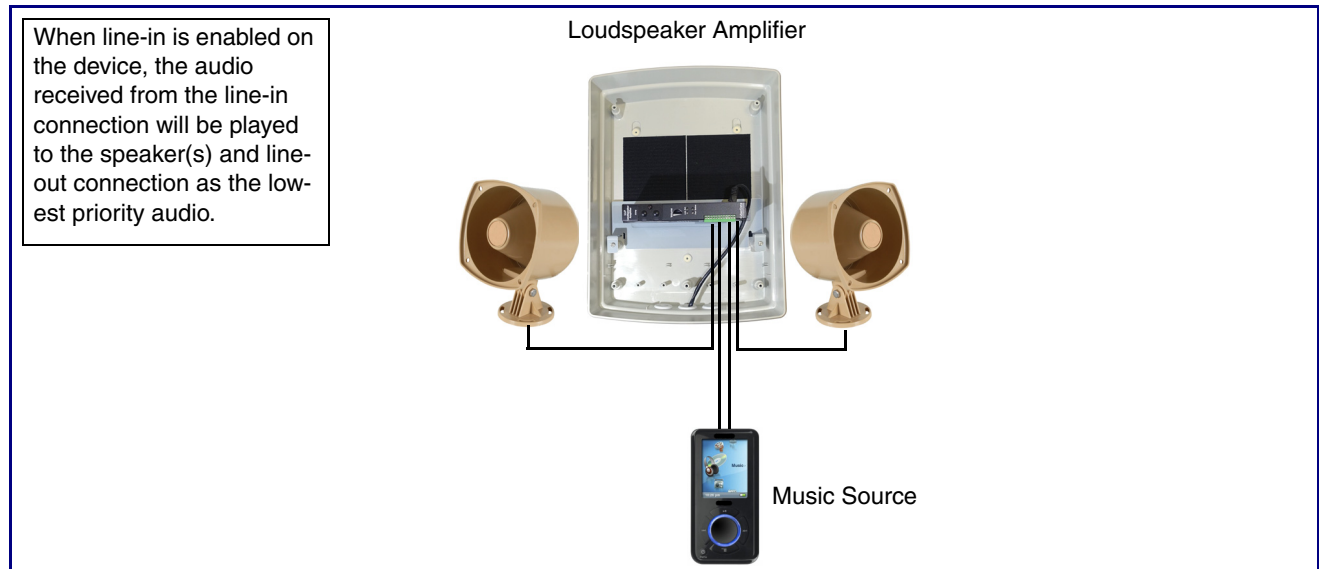

Figure 2-11. Relay or LED Strobe Connection

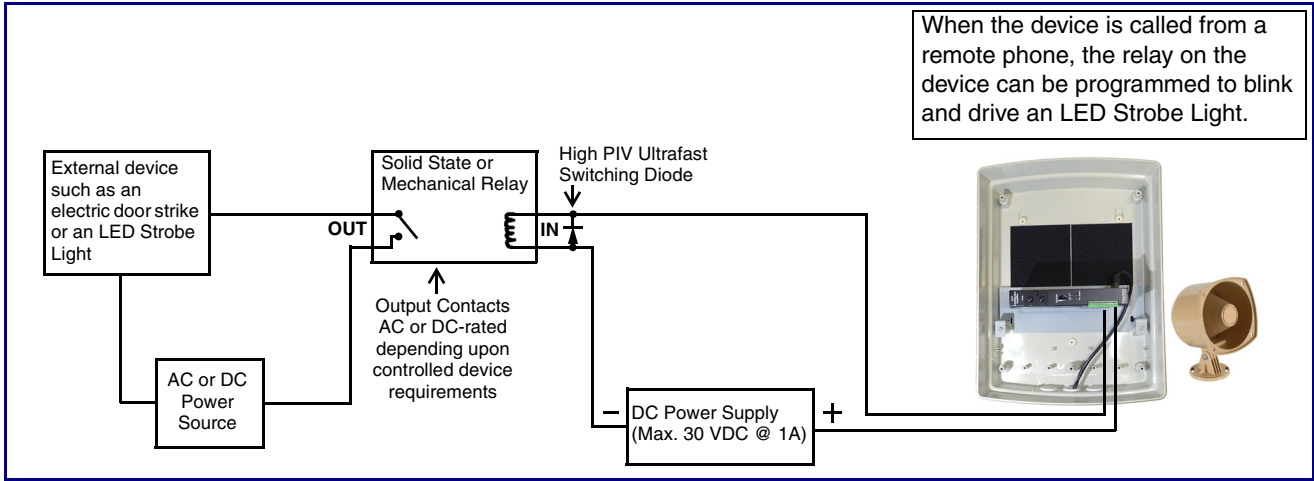
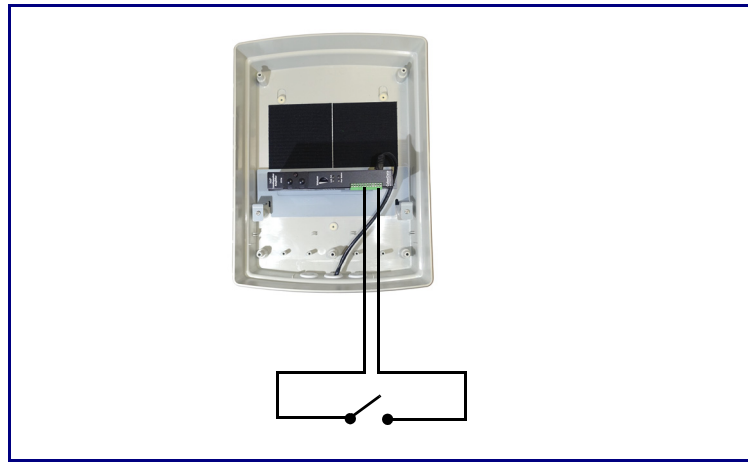

Figure 2-12. Sensor Connection



2.2.5 Strobe Connections Behind the Port Cover

See [Figure 2-13](#) for the additional connection options for the SIP Loudspeaker Amplifier (PoE).

Figure 2-13. Connections Behind the Port Cover

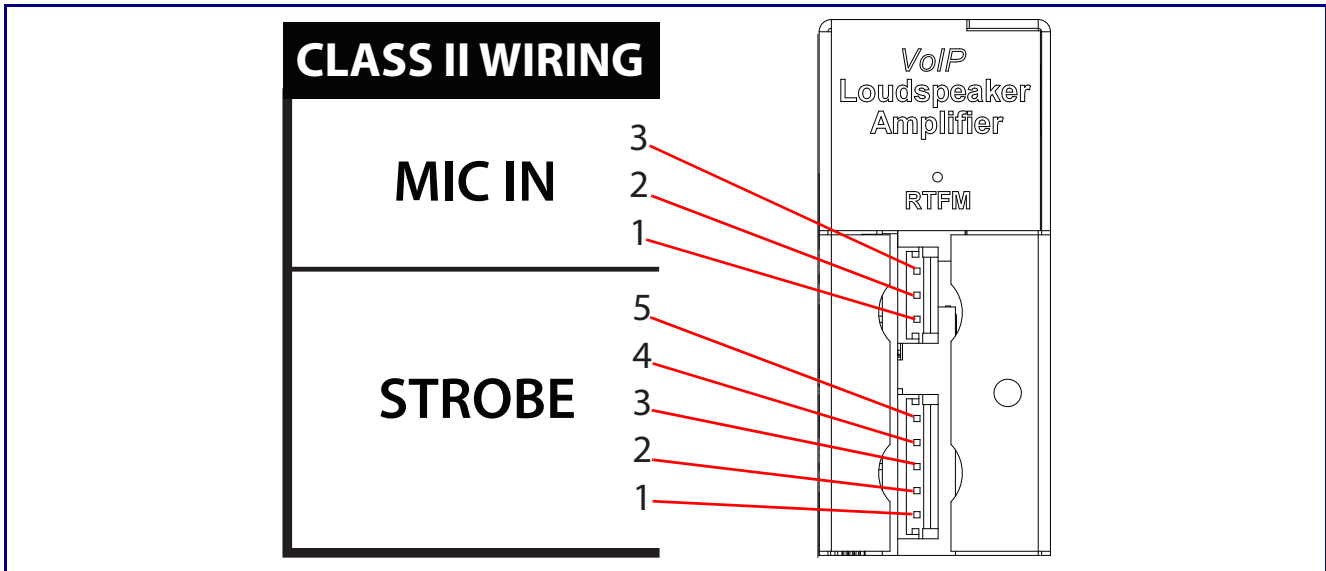

See [Table 2-4](#) for the descriptions of the connections behind the port cover.

Table 2-4. Connections Behind the Port Cover

Name	Connection	Description
MIC IN	J6-1	Microphone chassis ground connections
	J6-2	Microphone positive input
	J6-3	Microphone negative input
Strobe Connections		
Name	Connection	Description
STROBE	J9-1	Ground
	J9-2	Strobe positive power (+24V)
	J9-3	Ground
	J9-4	I2C data
	J9-5	I2C clock

2.2.6 Connecting the Strobe

1. Insert the network cable through any available rubber grommet at the bottom of the enclosure. See [Figure 2-14](#).
2. Connect the Network Cable to the Paging Amplifier. See [Figure 2-14](#).

Figure 2-14. Connecting the Strobe

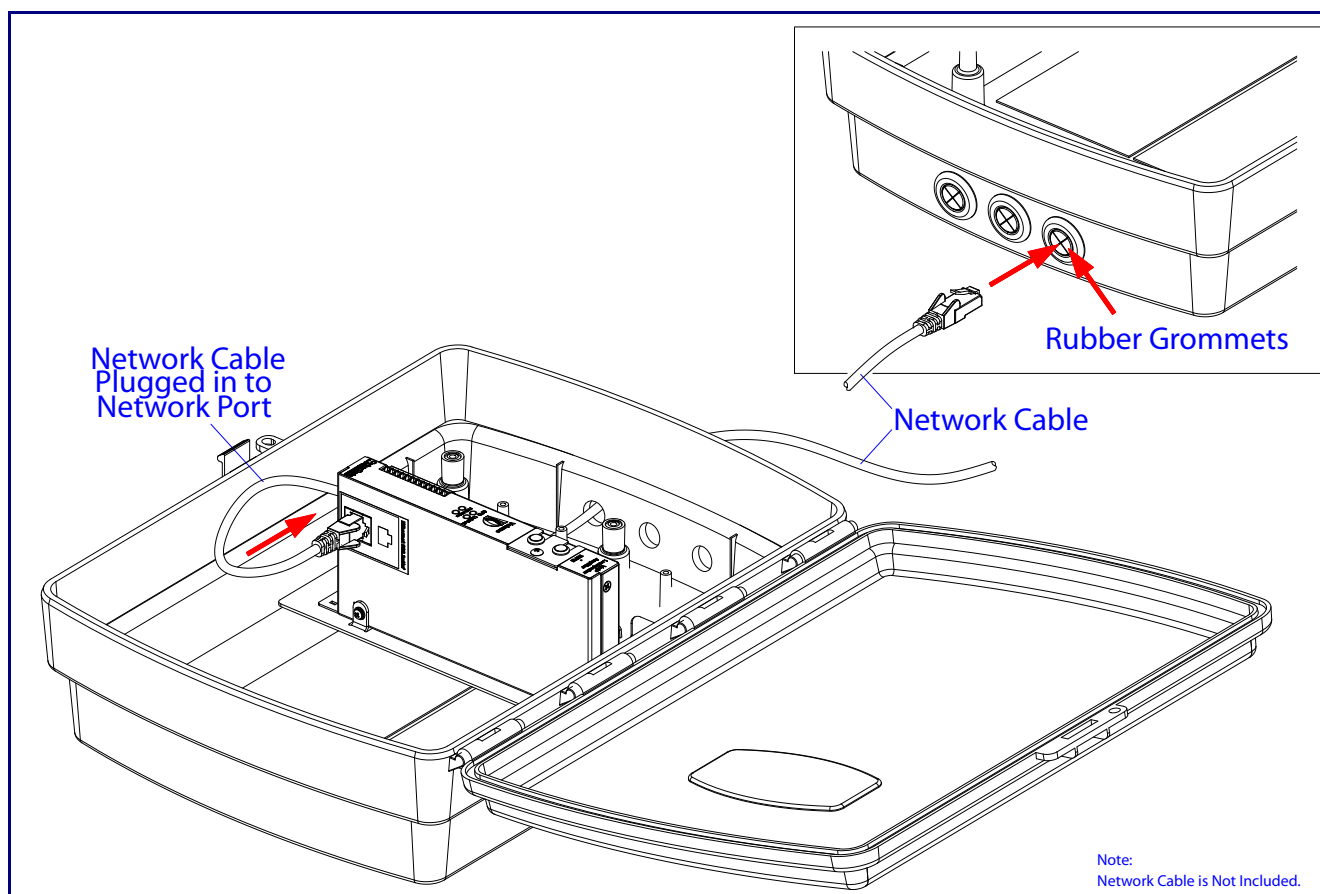

3. Remove the mounting screw to remove the cover plate. See [Figure 2-15](#).
4. Remove the hole plug and grommet. See [Figure 2-15](#).
5. Slide the cover plate through the slot on the cable grommet. See [Figure 2-15](#).
6. Install the mounting screw to secure the cover plate. See [Figure 2-15](#).

Figure 2-15. Connecting the Strobe

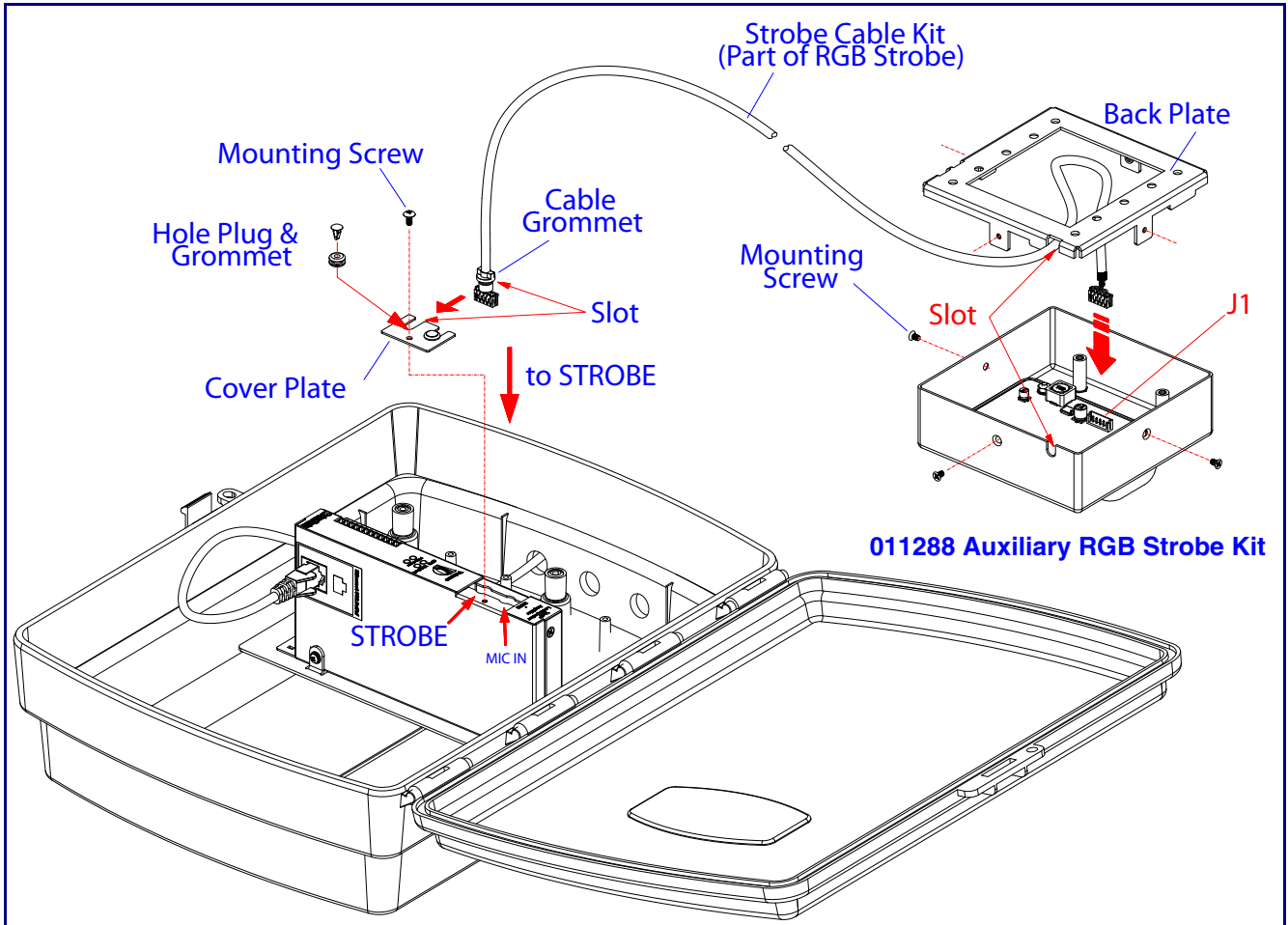

2.2.7 SIP Loudspeaker Amplifier (PoE) Jumpers

See [Figure 2-16](#) for the jumper locations.

Figure 2-16. Jumper Locations

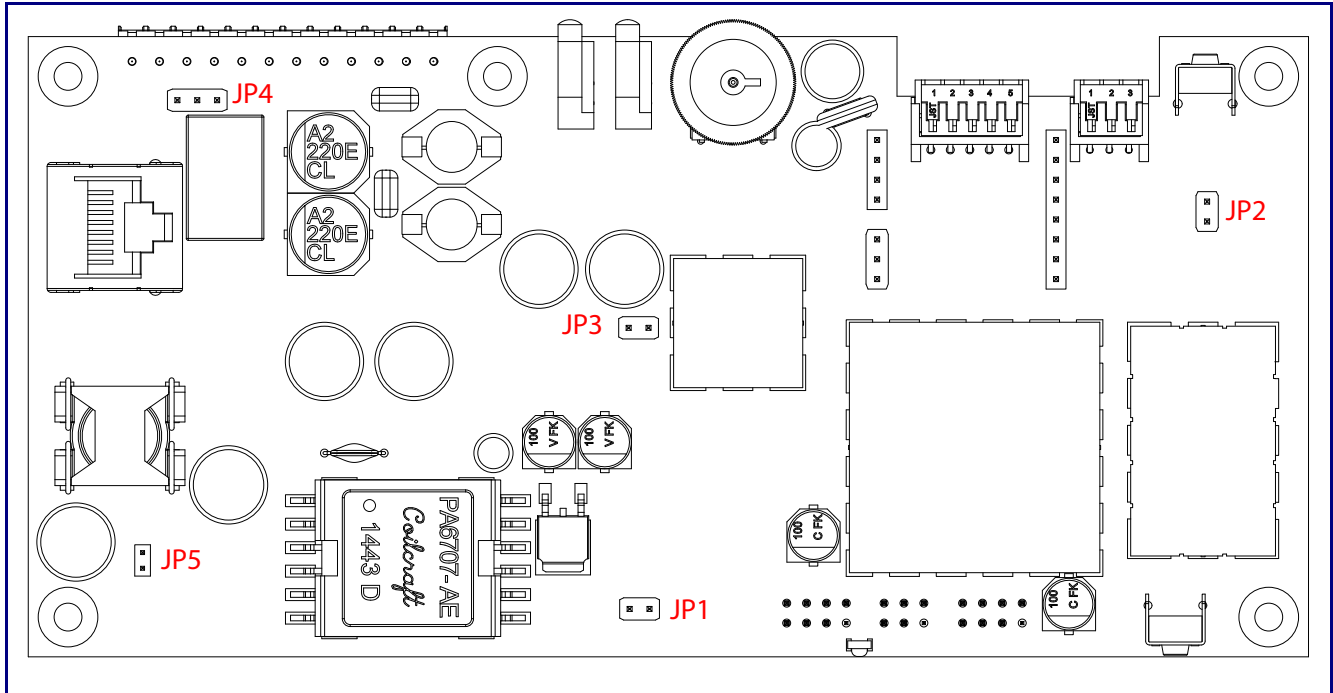

See [Table 2-5](#) for the jumper descriptions.

Table 2-5. Jumper Descriptions

Jumper	Description
JP1	Reset—Factory Only
JP2	RTFM (not installed)
JP3	Audio Enable Jumper—Factory Only
JP4	Relay NO/NC (default to NO)—Factory Only
JP5	PoE IEEE 802.3at—Factory Only

2.2.8 Ethernet Connection

See [Table 2-6](#) for details about the SIP Loudspeaker Amplifier (PoE) connection.

Table 2-6. SIP Loudspeaker Amplifier (PoE) Connection

Connection	Connection Details	Location
Ethernet	Use a RJ 45 cable.	SIP Loudspeaker Amplifier (PoE)

2.2.9 Loudspeaker Type

Using the amplified output, the CyberData SIP Loudspeaker Amplifier (PoE) supports the 011068 Loudspeaker or equivalent unamplified loudspeaker.

Figure 2-17. 011068 Loudspeaker



2.2.10 Cabling/Wiring

Using the amplified output, you may connect a 011068 loudspeaker or equivalent unamplified speaker to a SIP Loudspeaker Amplifier (PoE-powered) with good quality speaker wire that is 16 gauge and limited to 25 feet in length with two loudspeakers or 50 feet in length with one loudspeaker.

2.2.11 Confirm Operation

After connecting the device to the 802.3af compliant ethernet hub, use the LEDs on the device to confirm that the device is operational and linked to the network.

Table 2-7. SIP Loudspeaker Amplifier (PoE) LEDs

LED	Color	Function
Power (PWR)	BLUE/GREEN	<p>The 802.3at power injector that is provided with the device should cause the Power (PWR) LED to illuminate BLUE to indicate that high power is available.</p> <p>The Power (PWR) LED may illuminate GREEN if a low power mode (802.3af) power source is used (not included and sold separately).</p>
Status	GREEN	<p>After supplying power to the device, a steady GREEN Status LED illuminates.</p> <p>After about 20 seconds, the GREEN Status LED will blink fast to indicate that the device is acquiring an IP address and attempting to autoprovision. The GREEN Status LED will turn off thereafter until the device has finished booting. When the device has fully booted, the GREEN Status LED will turn on solid to confirm the device is operational.</p> <p>The GREEN Status LED will blink during a page when it is online.</p>
Speed (SPD)	AMBER	The Speed (SPD) LED illuminates AMBER for a 100Mb link or is off for 10MB when the network link to the device is established.
Link/Activity (Link/Act.)	GREEN	The Link/Activity (Link/Act.) GREEN LED blinks to indicate network traffic.

Figure 2-18. SIP Loudspeaker Amplifier (PoE) LEDs

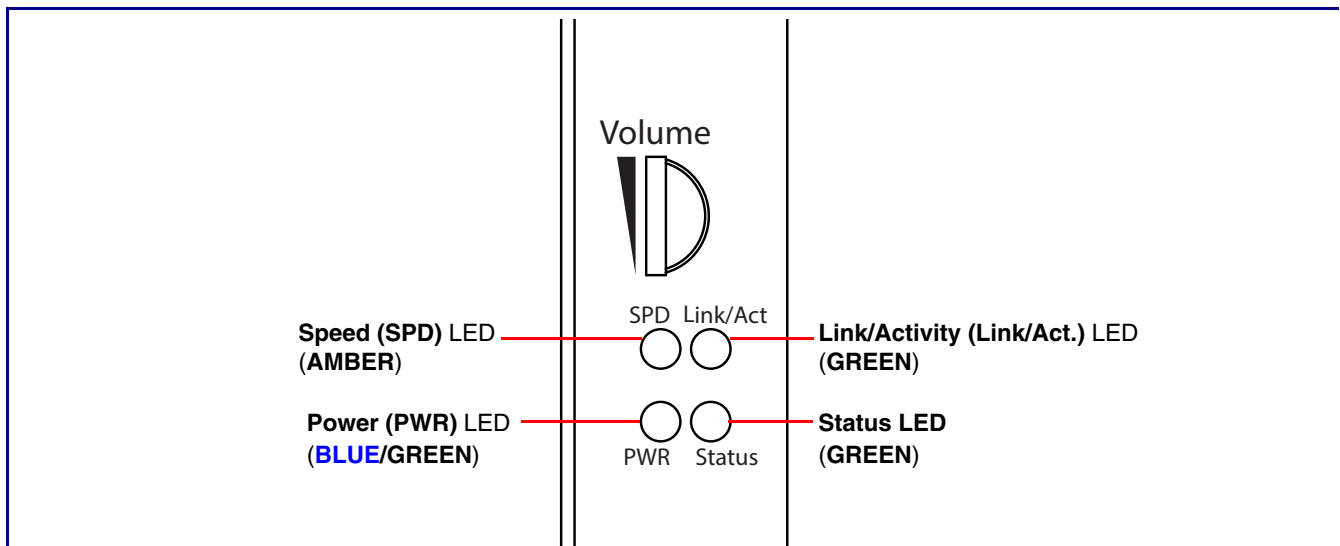

2.2.12 Confirm the IP Address and Test the Audio

2.2.12.1 RTFM Switch

When the SIP Loudspeaker Amplifier (PoE) is operational and linked to the network, use the Reset Test Function Management (**RTFM**) switch ([Figure 2-19](#)) (located behind the hole on the device) to announce and confirm the device's IP Address and test the audio to verify that it is working.

Figure 2-19. RTFM Switch

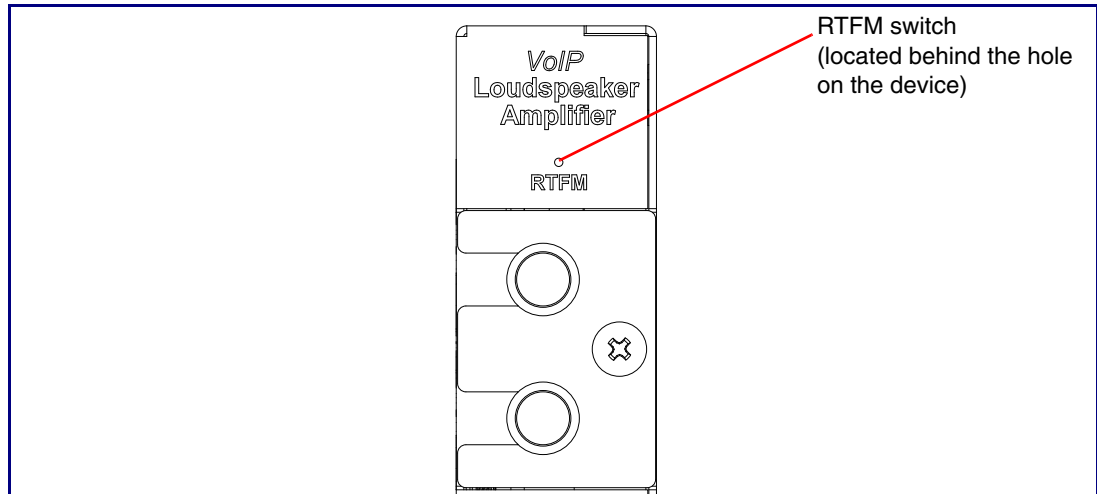

Announcing the IP Address To announce a device's current IP address:

- Use a bent paperclip or a similar object to press and hold the RTFM switch for a couple of seconds and then release it.



Caution

Equipment Caution: Pressing and holding the RTFM switch for more than five seconds will restore the device to the factory default settings. See the [“Restoring the Factory Default Settings”](#) section.

Restoring the Factory Default Settings

To restore the factory default settings, complete the following steps:

1. Use a bent paperclip or a similar object to press and hold the RTFM switch until you hear the device announce the words, “restoring defaults” and “rebooting”.
2. Release the RTFM switch. The device will be restored to the factory default settings.

2.2.13 Adjust the Volume

There are two ways to adjust the volume for the SIP Loudspeaker Amplifier (PoE):

- The **SIP Volume** setting on the **Device Page**
- The external **Volume** dial (Figure 2-21) on the SIP Loudspeaker Amplifier (PoE) face

Figure 2-20. External Volume Dial

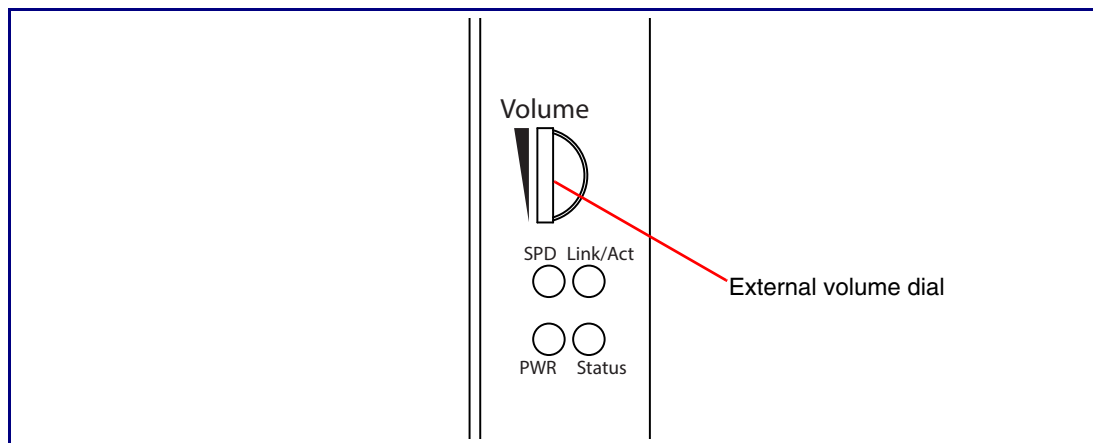

2.2.13.1 The SIP Volume Setting

To adjust the volume of the device with the **SIP Volume** setting on the **Device Page**, complete the following steps:

1. Go to the **Home Page**.
2. Select the **Device Page** page.
3. In the **SIP Volume** box, type a number between **0** (lowest) and **9** (highest).
4. Select **Save**.

2.2.13.2 The Multicast Volume Setting

To adjust the **Multicast Volume** volume with the **Multicast Volume** setting on the **Device Page**, complete the following steps:

1. Go to the **Home Page**.
2. Select the **Device Page**.
3. In the **Multicast Volume** box, type a number between **0** (lowest) and **9** (highest).
4. Select **Save**.

2.2.13.3 The Ring Volume Setting

To adjust the **Ring Volume** volume with the **Ring Volume** setting on the **Device Page**, complete the following steps:

1. Go to the **Home Page**.
2. Select the **Device Page**.
3. In the **Multicast Volume** box, type a number between **0** (lowest) and **9** (highest).
4. Select **Save**.

2.2.13.4 The Sensor Volume Setting

To adjust the **Sensor Volume** volume with the **Sensor Volume** setting on the **Device Page**, complete the following steps:

1. Go to the **Home Page**.
2. Select the **Device Page**.
3. In the **Sensor Volume** box, type a number between **0** (lowest) and **9** (highest).
4. Select **Save**.

2.2.13.5 The Loopback Volume Setting

To adjust the **Loopback Volume** volume with the **Loopback Volume** setting on the **Device Page**, complete the following steps:

1. Go to the **Home Page**.
2. Select the **Device Page**.
3. In the **Loopback Volume** box, type a number between **0** (lowest) and **9** (highest).
4. Select **Save**.

2.2.13.6 External Volume Dial

To adjust the SIP Loudspeaker Amplifier (PoE) volume with the external volume dial, complete the following steps:

1. Turn the external **Volume** dial ([Figure 2-20](#)) on the SIP Loudspeaker Amplifier (PoE) face.

Note For the lineout volume, the volume is fixed and the volume control is adjusted through an external amplifier.

Figure 2-21. External Volume Dial

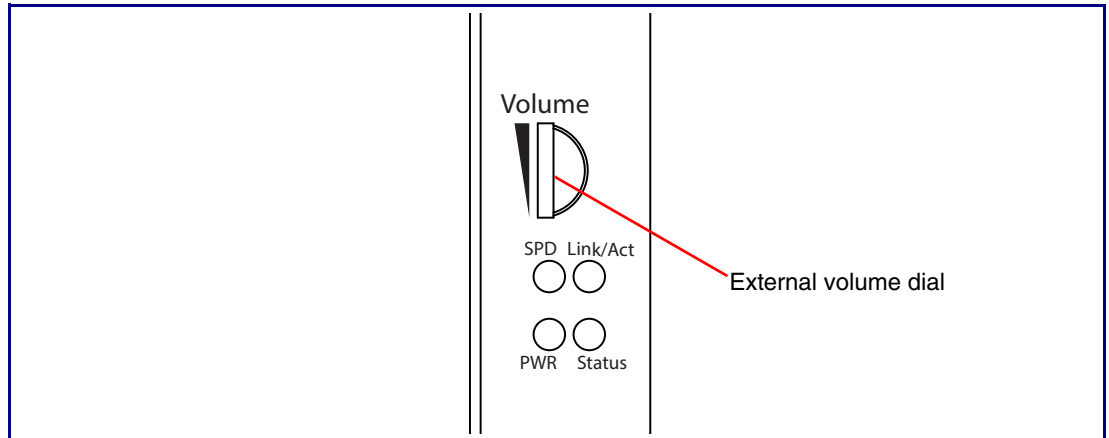

2.3 Configure the SIP Loudspeaker Amplifier (PoE) Parameters

To configure the SIP Loudspeaker Amplifier (PoE) online, use a standard web browser.

Configure each SIP Loudspeaker Amplifier (PoE) and verify its operation *before* you mount it. When you are ready to mount an SIP Loudspeaker Amplifier (PoE), refer to [Appendix A, "Mounting the Amplifier"](#) for instructions.

2.3.1 Factory Default Settings

All SIP Loudspeaker Amplifier (PoE)s are initially configured with the following default IP settings:

When configuring more than one SIP Loudspeaker Amplifier (PoE), attach the SIP Loudspeaker Amplifier (PoE)s to the network and configure one at a time to avoid IP address conflicts.

Table 2-8. Factory Default Settings





Parameter	Factory Default Setting
IP Addressing	DHCP
IP Address ^a	10.10.10.10
Web Access Username	admin
Web Access Password	admin
Subnet Mask ^a	255.0.0.0
Default Gateway ^a	10.0.0.1

a. Default if there is not a DHCP server present.

2.3.2 SIP Loudspeaker Amplifier (PoE) Web Page Navigation

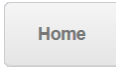
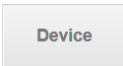
Table 2-9 shows the navigation buttons that you will see on every SIP Loudspeaker Amplifier (PoE) web page.

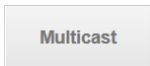
Table 2-9. Web Page Navigation

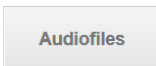
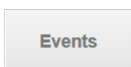
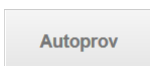
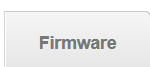
Web Page Item	Description
	Link to the Home page.
	Link to the Device page.
	Link to the Network page.
	Link to go to the SIP page.
	Link to the Multicast page.
	Link to the Sensor page.
	Link to the Audiofiles page.
	Link to the Events page.
	Link to the Autoprovisioning page.
	Link to the Firmware page.

2.3.3 Using the Toggle Help Button

The **Toggle Help** button allows you to see a short description of some of the settings on the webpage. To use the **Toggle Help** button, do the following:

1. Click on the **Toggle Help** button that is on the UI webpage. See [Figure 2-22](#) and [Figure 2-23](#).

Figure 2-22. Toggle/Help Button

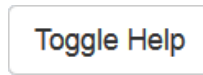

2. You will see a question mark (?) appear next to each web page item that has been provided with a short description by the Help feature. See [Figure 2-23](#).

Figure 2-23. Toggle Help Button and Question Marks

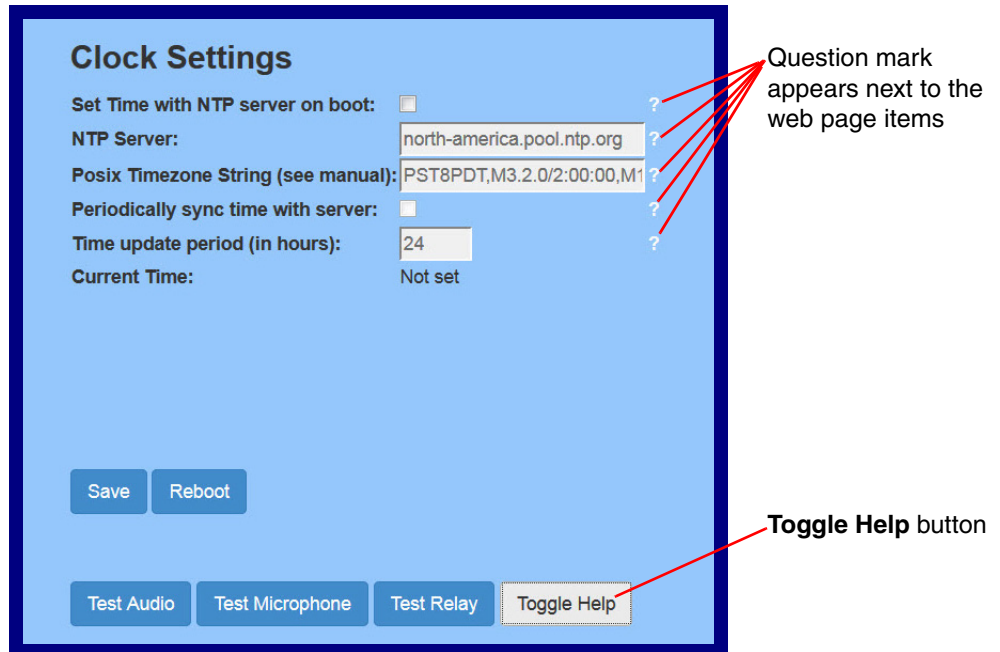

3. Move the mouse pointer to hover over the question mark (?), and a short description of the web page item will appear. See [Figure 2-24](#).

Figure 2-24. Short Description Provided by the Help Feature

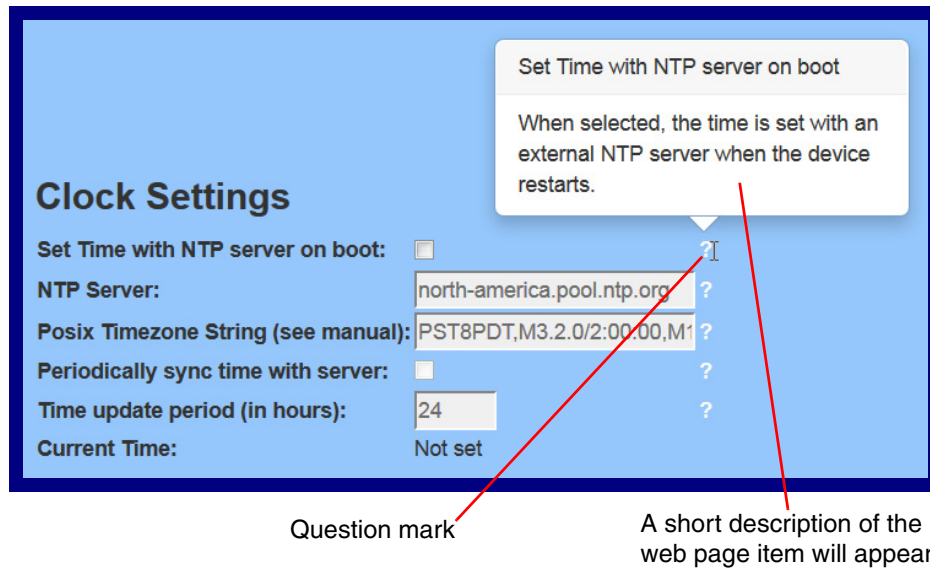

2.3.4 Using the Toggle Help Button

The **Toggle Help** button allows you to see a short description of some of the settings on the webpage. To use the **Toggle Help** button, do the following:

1. Click on the **Toggle Help** button that is on the UI webpage. See [Figure 2-22](#) and [Figure 2-23](#).

Figure 2-25. Toggle/Help Button

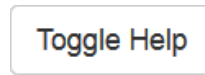

2. You will see a question mark (?) appear next to each web page item that has been provided with a short description by the Help feature. See [Figure 2-23](#).

Figure 2-26. Toggle Help Button and Question Marks

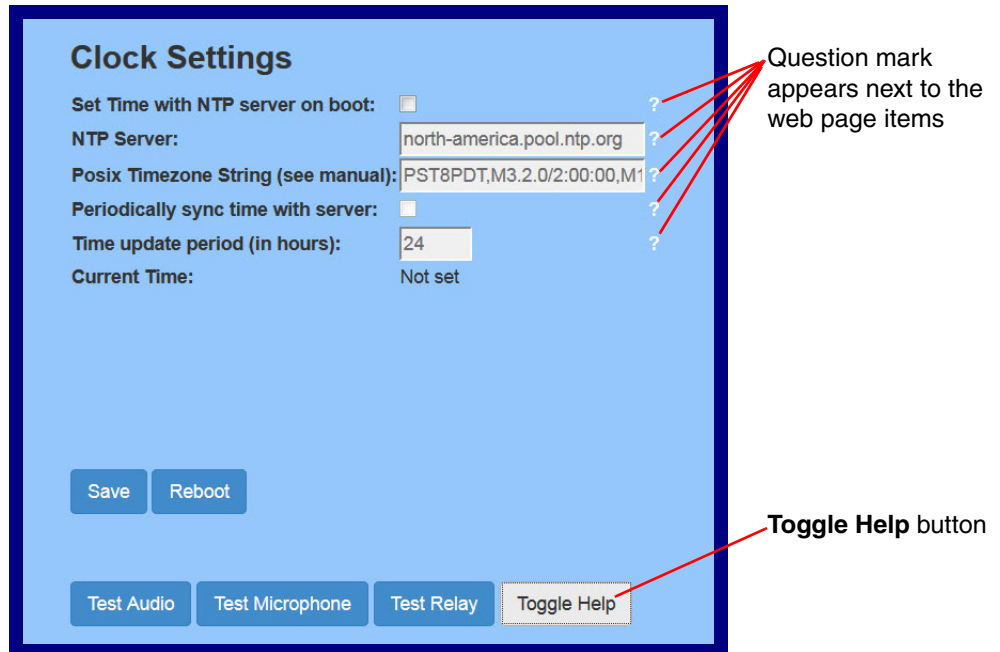

3. Move the mouse pointer to hover over the question mark (?), and a short description of the web page item will appear. See [Figure 2-24](#).

Figure 2-27. Short Description Provided by the Help Feature

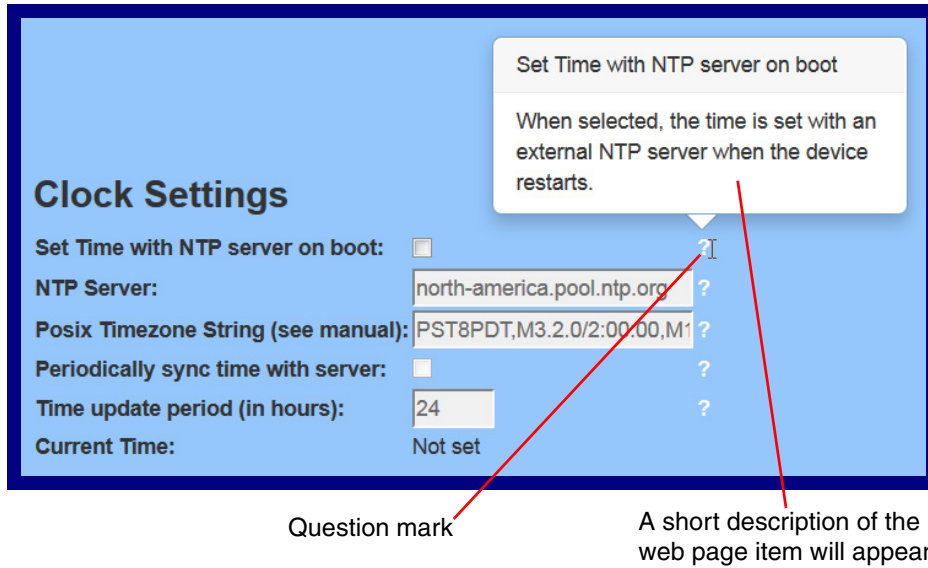

2.3.5 Log in to the Home Page

1. Open your browser to the device IP address.

Note If the network does not have access to a DHCP server, the device will default to an IP address of 10.10.10.10.

Note Make sure that the PC is on the same IP network as the SIP Loudspeaker Amplifier (PoE).

Note You may also download CyberData's VoIP Discovery Utility program which allows you to easily find and configure the default web address of the CyberData VoIP products.

CyberData's VoIP Discovery Utility program is available at the following website address:

<http://www.cyberdata.net/assets/common/discovery.zip>

Note The device ships in DHCP mode. To get to the **Home** page, use the discovery utility to scan for the device on the network and open your browser from there.

2. When prompted, use the following default **Web Access Username** and **Web Access Password** to access the **Home Page** (Figure 2-28):

Web Access Username: **admin**

Web Access Password: **admin**

Figure 2-28. Home Page

Home Device Network SIP Multicast Sensor Audiofiles Events Autoprov Firmware

CyberData Paging Amplifier

Current Status

Serial Number: 405100001
Mac Address: 00:02:c1:81:0b:9b
Firmware Version: v11.6.4

IP Addressing: DHCP
IP Address: 10.10.1.152
Subnet Mask: 255.0.0.0
Default Gateway: 10.0.0.1
DNS Server 1: 10.0.1.56
DNS Server 2:

SIP Mode: Enabled
Multicast Mode: Disabled
Event Reporting: Disabled
Nightringer: Disabled

Primary SIP Server: **Not registered**
Backup Server 1: Not registered
Backup Server 2: Not registered
Nightringer Server: Not registered

Admin Settings

Username:
Password:
Confirm Password:

Import Settings

No file chosen

Export Settings

3. On the **Home** page, review the setup details and navigation buttons described in [Table 2-10](#).

Note The question mark icon (?) in the following table shows which web page items will be defined after the **Toggle Help** button is pressed.

Table 2-10. Home Page Overview





Web Page Item	Description
Admin Settings	
Username ?	The username to access the web interface. Enter up to 25 characters.
Password ?	The password to access the web interface. Enter up to 25 characters.
Confirm Password ?	Confirm the web interface password.
Current Status	
Serial Number	Shows the device serial number.
Mac Address	Shows the device Mac address.
Firmware Version	Shows the current firmware version.
IP Addressing	Shows the current IP addressing setting (DHCP or static).
IP Address	Shows the current IP address.
Subnet Mask	Shows the current subnet mask address.
Default Gateway	Shows the current default gateway address.
DNS Server 1	Shows the current DNS Server 1 address.
DNS Server 2	Shows the current DNS Server 2 address.
SIP Mode	Shows the current status of the SIP mode.
Multicast Mode	Shows the current status of the Multicast mode.
Event Reporting	Shows the current status of the Event Reporting mode.
Nightringer	Shows the current status of the Nightringer mode.
Primary SIP Server	Shows the current status of the Primary SIP Server.
Backup Server 1	Shows the current status of Backup Server 1.
Backup Server 2	Shows the current status of Backup Server 2.
Nightringer Server	Shows the current status of Nightringer Server.
Import Settings	
	Use this button to select a configuration file to import.
	After selecting a configuration file, click Import to import the configuration from the selected file. Then, click Save and Reboot to store changes.
Export Settings	
	Click Export to export the current configuration to a file.
	Click the Save button to save your configuration settings. Note: You need to reboot for changes to take effect.

Table 2-10. Home Page Overview (continued)

Web Page Item	Description
	Click on the Reboot button to reboot the system.
	Click on the Toggle Help button to see a short description of some of the web page items. First click on the Toggle Help button, and you will see a question mark (?) appear next to some of the web page items. Move the mouse pointer to hover over a question mark to see a short description of a specific web page item.

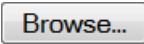
2.3.6 Configure the Device

1. Click the **Device** menu button to open the **Device** page. See [Figure 2-29](#).

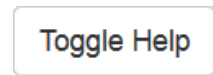
Figure 2-29. Device Page



2. On the **Device** page, you may enter values for the parameters indicated in [Table 2-11](#).

Note The question mark icon (?) in the following table shows which web page items will be defined after the **Toggle Help** button is pressed.











Table 2-11. Device Page Parameters

Web Page Item	Description
Volume Settings (0-9)	
Disable Volume Control Dial ?	Select this option to disable the volume control dial and enable digital volume control settings.
SIP Volume ?	Set the speaker volume for a SIP call. A value of 0 will mute the speaker during SIP calls.
Multicast Volume ?	Set the speaker volume for multicast audio streams. A value of 0 will mute the speaker during multicasts.
Ring Volume ?	Set the ring volume for incoming calls. A value of 0 will mute the speaker instead of playing the ring tone when Auto-Answer Incoming Calls is disabled.
Sensor Volume ?	Set the speaker volume for playing sensor activated audio. A value of 0 will mute the speaker during sensor activated audio.
Loopback Volume ?	Speaker volume for Line-in Loopback. This value only affects the volume of the speaker(s). Line-out volume must be controlled by the amplifier connected to the line-out port.
Volume Boost: ? No Volume Boost +4dB	Set the Boost level to increase the volume output of the speaker. Using Volume Boost may introduce audio clipping and/or distortion. Boost is only recommended for use with volumes set to level 9.
Clock Settings	
Set Time with NTP Server on boot ?	When selected, the time is set with an external NTP server when the device restarts.
NTP Server ?	Use this field to set the address (in IPv4 dotted decimal notation or as a canonical name) for the NTP Server. This field can accept canonical names of up to 64 characters in length.
Posix Timezone String ?	See Section 2.3.6.1, "Time Zone Strings" for information about how to use the Posix Timezone String to specify time zone and daylight savings time where applicable. Enter up to 63 characters.
Periodically sync time with server ?	When selected, the time is periodically updated with the NTP server at the configured interval below.
Time update period (in hours) ?	The time interval after which the device will contact the NTP server to update the time. Enter up to 4 digits.
Current Time ?	Allows you to input the current time. (6 character limit)
Power Settings	
802.3AT Mode ?	This device automatically detects if it is plugged into an 802.3AT (also known as PoE Plus) power source. 802.3AT provides more power than older 802.3AT power sources and allows this speaker to play audio at higher volumes. If you are sure this speaker is connected to an 802.3AT power source, but it is not being detected correctly, you can override the automatic settings below.

Table 2-11. Device Page Parameters (continued)

Web Page Item	Description
Force 802.3AT Mode (NOT recommended) ?	Enable this option if you are sure this speaker is connected to an 802.3AT power source, but it is not being detected correctly (not recommended).
Auxiliary Power Supply ?	This device can be connected to a +24VDC auxiliary power supply. Check this box if this is how this speaker is being powered.
Line-In Settings	
Enable Line-in to Line-out Loopback ?	Line-in audio will play back out the device's audio output ports. This is the lowest priority audio and will be preempted by any other audio stream.
DTMF Settings	
Require Security Code ?	When selected, the user will be prompted to enter a Security Code (entered on this page) before being able to execute a page when calling the device.
Security Code ?	Type the Security Code in this field. The Security Code must only use characters '0-9', '*' and '#'. Enter up to 25 characters.
Enable Stored Message Playback ?	When selected, the caller will be prompted to select one of nine stored messages to play through the speaker. Stored messages may be customized on the Audiofiles page.
Relay Settings	
Activate Relay with DTMF Code ?	Activates the relay when the DTMF Activation Code is entered on the phone during a SIP call with the device. RFC2833 DTMF payload types are supported.
Relay Pulse Code ?	DTMF code used to pulse the relay when entered on a phone during a SIP call with the device. Relay will activate for Relay Pulse Duration seconds then deactivate. Activate Relay with DTMF Code must be enabled. Enter up to 25 digits (* and # are supported).
Relay Pulse Duration (in seconds) ?	The length of time (in seconds) during which the relay will be activated when the DTMF Relay Activation Code is detected. Enter up to 5 digits.
Relay Activation Code ?	Activation code used to activate the relay when entered on a phone during a SIP call with the device. Relay will be active indefinitely, or until the DTMF Relay Deactivation code is entered. Activate Relay with DTMF Code must be enabled. Enter up to 25 digits (* and # are supported).
Relay Deactivation Code ?	Code used to deactivate the relay when entered on a phone during a SIP call with the device. Activate Relay with DTMF Code must be enabled. Enter up to 25 digits (* and # are supported).
Activate Relay During Ring ?	When selected, the relay will be activated for as long as the device is ringing. When Auto-Answer Incoming Calls is enabled, the device will not ring and this option does nothing.
Activate Relay During Night Ring ?	When selected, the relay will be activated as long as the Nightringer extension is ringing.
Activate Relay While Call Active ?	When selected, the relay will be activated as long as the SIP call is active.
Misc Settings	
Device Name ?	Type the device name. Enter up to 25 characters.
Auto-Answer Incoming Calls ?	When selected, the device will automatically answer incoming calls. When Auto-Answer Incoming Calls is disabled, the device will play a ring tone (corresponds to Ring Tone on the Audiofiles page) out of the speaker.

Table 2-11. Device Page Parameters (continued)

Web Page Item	Description
Beep on Init 	Device will play the user-defined “pagetone” audio file when it boots.
Beep on Page 	Device will play the user defined “pagetone” audio file before playing a SIP page.
Disable HTTPS (NOT recommended) 	Disables the encrypted connection to the webpage. We do not recommend disabling HTTPS for security reasons.
Two Speakers Connected 	Specify if one or two speakers are connected to the paging amplifier. If only one is connected, ensure that it is wired to the first set of terminal blocks.
RGB Strobe 	Status of optional RGB Strobe.
	Click on the Test Audio button to do an audio test. When the Test Audio button is pressed, you will hear a voice message for testing the device audio quality and volume.
	Click on the Test Relay button to do a relay test.
	Click the Save button to save your configuration settings. Note: You need to reboot for changes to take effect.
	Click on the Reboot button to reboot the system.
	Click on the Toggle Help button to see a short description of some of the web page items. First click on the Toggle Help button, and you will see a question mark () appear next to some of the web page items. Move the mouse pointer to hover over a question mark to see a short description of a specific web page item.

Note You can change the **SIP Volume**, **Multicast Volume**, **Ring Volume**, and **Sensor Volume** without rebooting the device. You must save and reboot the device for other changes to take effect.

2.3.6.1 Time Zone Strings

The posix time zone string tells the internal date and time utilities how to handle daylight savings time for different time zones. [Table 2-24](#) shows some common strings.

Table 2-12. Common Time Zone Strings

Time Zone	Time Zone String
US Pacific time	PST8PDT,M3.2.0/2:00:00,M11.1.0/2:00:00
US Mountain time	MST7MDT,M3.2.0/2:00:00,M11.1.0/2:00:00
US Eastern Time	EST5EDT,M3.2.0/2:00:00,M11.1.0/2:00:00
Phoenix Arizona ^a	MST7
US Central Time	CST6DST,M3.2.0/2:00:00,M11.1.0/2:00:00

a. Phoenix, Arizona does not use daylight savings time.

[Table 2-25](#) shows a breakdown of the parts that constitute the following time zone string:

- ***CST6DST,M3.2.0/2:00:00,M11.1.0/2:00:00***

Table 2-13. Time Zone String Parts

Time Zone String Part	Meaning
CST6CDT	The time zone offset from GMT and three character identifiers for the time zone.
CST	Central Standard Time
6	The (hour) offset from GMT/UTC
CDT	Central Daylight Time
M3.2.0/2:00:00	The date and time when daylight savings begins.
M3	The third month (March)
.2	The 2nd occurrence of the day (next item) in the month
.0	Sunday
/2:00:00	Time of day to change
M11.1.0/2:00:00	The date and time when daylight savings ends.
M11	The eleventh month (November)
.1	The 1st occurrence of the day (next item) in the month
.0	Sunday
/2:00:00	Time of day to change

Time Zone String Examples [Table 2-26](#) has some more examples of time zone strings.

Table 2-14. Time Zone String Examples

Time Zone	Time Zone String
Tokyo ^a	IST-9
Berlin ^b	CET-1MET,M3.5.0/1:00,M10.5.0/1:00

- a. Tokyo does not use daylight savings time.
- b. For Berlin, daylight savings time starts on the last Sunday in March at 01:00 UTC, and ends on the last Sunday in October at 01:00 UTC, and is one hour ahead of UTC.

Time Zone Identifier A user-definable three or four character time zone identifier (such as PST, EDT, IST, MUT, etc) is needed at the beginning of the posix time zone string to properly set the time. However, the specific letters or numbers used for the time zone identifier are not important and can be any three or four letter or number combination that is chosen by the user. However, the time zone identifier cannot be blank.

Figure 2-30. Three or Four Character Time Zone Identifier

You can also use the following URL when a certain time zone applies daylight savings time:

<http://www.timeanddate.com/time/dst/2011.html>

World GMT Table [Table 2-27](#) has information about the GMT time in various time zones.

Table 2-15. World GMT Table

Time Zone	City or Area Zone Crosses
GMT-12	Eniwetok
GMT-11	Samoa
GMT-10	Hawaii
GMT-9	Alaska
GMT-8	PST, Pacific US
GMT-7	MST, Mountain US
GMT-6	CST, Central US
GMT-5	EST, Eastern US
GMT-4	Atlantic, Canada
GMT-3	Brazilia, Buenos Aries
GMT-2	Mid-Atlantic
GMT-1	Cape Verdes
GMT	Greenwich Mean Time, Dublin
GMT+1	Berlin, Rome
GMT+2	Israel, Cairo
GMT+3	Moscow, Kuwait
GMT+4	Abu Dhabi, Muscat

Table 2-15. World GMT Table (continued)

Time Zone	City or Area Zone Crosses
GMT+5	Islamabad, Karachi
GMT+6	Almaty, Dhaka
GMT+7	Bangkok, Jakarta
GMT+8	Hong Kong, Beijing
GMT+9	Tokyo, Osaka
GMT+10	Sydney, Melbourne, Guam
GMT+11	Magadan, Soloman Is.
GMT+12	Fiji, Wellington, Auckland

2.3.7 Configure the Network Parameters

1. Click the **Network** menu button to open the **Network** page (Figure 2-31).

Figure 2-31. Network Page

The screenshot shows the Network configuration page for the CyberData Paging Amplifier. At the top, there is a navigation bar with tabs for Home, Device, Network (selected), SIP, Multicast, Sensor, Audiofiles, Events, Autoprovisioning, and Firmware. The main title is "CyberData Paging Amplifier".

Stored Network Settings

Addressing Mode: Static DHCP

Hostname:

IP Address:

Subnet Mask:

Default Gateway:

DNS Server 1:

DNS Server 2:

DHCP Timeout in seconds*:

* A value of -1 will retry forever

VLAN Settings

VLAN ID (0-4095):

VLAN Priority (0-7):

Current Network Settings

IP Address: 10.10.1.182

Subnet Mask: 255.0.0.0

Default Gateway: 10.0.0.1

DNS Server 1: 10.0.1.56

DNS Server 2:

Buttons: Save, Reboot, Toggle Help



2. On the **Network** page, enter values for the parameters indicated in [Table 2-16](#).

Note The question mark icon (?) in the following table shows which web page items will be defined after the **Toggle Help** button is pressed.

Table 2-16. Network Page Parameters

Web Page Item	Description
Stored Network Settings	
Addressing Mode ?	Select either DHCP IP Addressing or Static Addressing by marking the appropriate radio button. DHCP Addressing mode is enabled on default and the device will attempt to resolve network addressing with the local DHCP server upon boot. If DHCP Addressing fails, the device will revert to the last known IP address or the factory default address if no prior DHCP lease was established. See Section 2.3.1, "Factory Default Settings" for factory default settings. Be sure to click Save and Reboot to store changes when configuring a Static address.
Hostname ?	This is the hostname provided by the DHCP server. See the DHCP/DNS server documentation for more information. Enter up to 64 characters.
IP Address ?	Enter the Static IPv4 network address in dotted decimal notation.
Subnet Mask ?	Enter the Subnet Mask in dotted decimal notation.
Default Gateway ?	Enter the Default Gateway IPv4 address in dotted decimal notation.
DNS Server 1 ?	Enter the primary DNS Server IPv4 address in dotted decimal notation.
DNS Server 2 ?	Enter the secondary DNS Server IPv4 address in dotted decimal notation.
DHCP Timeout in seconds ?	Specify the desired time-out duration (in seconds) that the device will wait for a response from the DHCP server before reverting back to the stored static IP address. The stored static IP address may be the last known IP address or the factory default address if no prior DHCP lease was established. Enter up to 8 characters. A value of -1 will retry forever.
Current Network Settings	
IP Address	Shows the current Static IP address.
Subnet Mask	Shows the current Subnet Mask address.
Default Gateway	Shows the current Default Gateway address.
DNS Server 1	Shows the current DNS Server 1 address.
DNS Server 2	Shows the current DNS Server 2 address.
VLAN Settings	
VLAN ID (0-4095) ?	Specify the IEEE 802.1Q VLAN ID number. Enter up to 4 digits. Note: The device supports 802.1Q VLAN tagging support. The switch port connected to the device will need to be in "trunking mode" for the VLAN tags to propagate.
VLAN Priority (0-7) ?	Specify the IEEE 802.1p VLAN priority level. Enter 1 digit. A value of 0 may cause the VLAN ID tag to be ignored.

Table 2-16. Network Page Parameters (continued)

Web Page Item	Description
	Click the Save button to save your configuration settings. Note: You need to reboot for changes to take effect.
	Click on the Reboot button to reboot the system.
	Click on the Toggle Help button to see a short description of some of the web page items. First click on the Toggle Help button, and you will see a question mark (?) appear next to some of the web page items. Move the mouse pointer to hover over a question mark to see a short description of a specific web page item.

Note You must click on the **Save** button and then the **Reboot** button for the changes to take effect.

2.3.8 Configure the SIP (Session Initiation Protocol) Parameters

1. Click on the **SIP** menu button to open the **SIP** page (Figure 2-32).

Figure 2-32. SIP Page

The screenshot shows the configuration interface for the SIP settings of a CyberData Paging Amplifier. The interface includes a navigation menu at the top with the 'SIP' tab selected. The main content area is titled 'CyberData Paging Amplifier' and contains several configuration sections:

- SIP Settings:** Includes checkboxes for 'Enable SIP operation' and 'Register with a SIP Server'. It features input fields for 'Primary SIP Server' (10.0.0.253), 'Primary SIP User ID' (199), 'Primary SIP Auth ID' (199), and 'Primary SIP Auth Password' (masked). There are also fields for backup servers and ports (Remote SIP Port: 5060, Local SIP Port: 5060, Outbound Proxy Port: 0).
- Nightringer Settings:** Includes a checkbox for 'Enable Nightringer' and input fields for 'SIP Server' (10.0.0.253), 'Remote SIP Port' (5060), 'Local SIP Port' (5061), 'Outbound Proxy Port' (0), 'User ID' (241), 'Authenticate ID' (241), 'Authenticate Password' (masked), and 'Re-registration Interval (in seconds)' (360).
- Nightringer Strobe Settings:** Includes a checkbox for 'Blink Strobe on Nightring' and a table for configuring scene colors and brightness. The table has columns for Scene, Color, Brightness, Red, Green, and Blue. A 'Preview' button is present.
- RTP Settings:** Includes input fields for 'RTP Port (even):' (10500) and 'Jitter Buffer:' (50).
- Call Disconnection:** Includes an input field for 'Terminate Call after delay:' (0).
- SIP Strobe Settings:** Includes a checkbox for 'Blink Strobe on Ring' and a table for configuring scene colors and brightness, similar to the Nightringer Strobe settings.
- MWI Strobe Settings:** Includes a checkbox for 'Blink Strobe on MWI' and a table for configuring scene colors and brightness, similar to the Nightringer Strobe settings.

At the bottom of the page, there are three buttons: 'Save', 'Reboot', and 'Toggle Help'.

2. On the **SIP** page, enter values for the parameters indicated in [Table 2-17](#).

Note The question mark icon (?) in the following table shows which web page items will be defined after the **Toggle Help** button is pressed.

Table 2-17. SIP Page Parameters

Web Page Item	Description
SIP Settings	
Enable SIP Operation ?	When enabled, the device will transmit, receive, and process SIP messages according to the configured SIP settings below.
Register with a SIP Server ?	When enabled, the device will attempt to register to the configured SIP Server(s) on this page. To configure the device to send and receive point-to-point SIP calls, enable SIP Operation and disable Register with a SIP Server (see Section 2.3.8.2, "Point-to-Point Configuration").
Use Cisco SRST ?	When enabled, the backup servers are handled according to Cisco SRST (Survivable Remote Site Telephony). It is required for use in clustered Cisco Unified Communications Manager topologies.
Primary SIP Server ?	Enter the SIP server address as an IPv4 address in dotted decimal notation or a fully qualified domain name. This parameter also becomes the host portion of the SIP-URI for the device's extension on the primary SIP server. This field can accept entries of up to 255 characters in length.
Primary SIP User ID ?	Specify the SIP User ID for the Primary SIP Server. This parameter becomes the user portion of the SIP-URI for the device's extension on the primary SIP server. Enter up to 64 alphanumeric characters.
Primary SIP Auth ID ?	Specify the Authenticate ID for the Primary SIP Server. This parameter is required for SIP registration authentication. Enter up to 64 alphanumeric characters.
Primary SIP Auth Password ?	Specify the Authenticate Password for the Primary SIP Server. This parameter is required for SIP registration authentication. Enter up to 64 alphanumeric characters.
Backup SIP Server 1 ?	Enter the backup SIP server address as an IPv4 address in dotted decimal notation or a fully qualified domain name. This parameter also becomes the host portion of the SIP-URI for the device's extension on the backup SIP server. This field can accept entries of up to 255 characters in length.
Backup SIP User ID 1 ?	Specify the SIP User ID for the first backup SIP Server. This parameter becomes the user portion of the SIP-URI for the device's extension on the first backup SIP server. Enter up to 64 alphanumeric characters.
Backup SIP Auth ID 1 ?	Specify the Authenticate ID for the first backup SIP server. This parameter is required for SIP registration authentication. Enter up to 64 alphanumeric characters.
Backup SIP Auth Password 1 ?	Specify the Authenticate Password for the first backup SIP server. This parameter is required for SIP registration authentication. Enter up to 64 alphanumeric characters.
Backup SIP Server 2 ?	Enter a second backup SIP server address as an IPv4 address in dotted decimal notation or a fully qualified domain name. This parameter also becomes the host portion of the SIP-URI for the device's extension on the second backup SIP server. This field can accept entries of up to 255 characters in length.

Table 2-17. SIP Page Parameters (continued)

Web Page Item	Description
Backup SIP User ID 2 ?	Specify the SIP User ID for the second backup SIP Server. This parameter becomes the user portion of the SIP-URI for the device's extension on the second backup SIP server. Enter up to 64 alphanumeric characters.
Backup SIP Auth ID 2 ?	Specify the Authenticate ID for the second backup SIP server. This parameter is required for SIP registration authentication. Enter up to 64 alphanumeric characters.
Backup SIP Auth Password 2 ?	Specify the Authenticate Password for the second backup SIP server. This parameter is required for SIP registration authentication. Enter up to 64 alphanumeric characters.
Remote SIP Port ?	The Remote SIP Port is the port number the device will use as the destination port when sending SIP messages. The default Remote SIP Port is 5060. The supported range is 0-65536. Enter up to 5 digits.
Local SIP Port ?	The Local SIP Port is the port number the device will use to receive SIP messages. The default Local SIP Port is 5060. The supported range is 0-65536. Enter up to 5 digits.
Outbound Proxy ?	Enter the Outbound Proxy address as an IPv4 address in dotted decimal notation or a fully qualified domain name (FQDN). When an IP address is configured, the device will send all SIP messages to this IP address. When an FQDN is configured, the device will run DNS NAPTR, SRV, and A queries on the FQDN to resolve an IP address to which it will send all SIP messages. This field can accept entries of up to 255 characters in length.
Outbound Proxy Port ?	The Outbound Proxy Port is port number used as the destination port when sending SIP messages to the outbound proxy. A value of 0 will default to 5060. The supported range is 0-65536. Enter up to 5 digits.
Disable rport Discovery ?	Disabling rport Discovery will prevent the device from including the public WAN IP address and port number in the contact information that is sent to the remote SIP servers. This will generally only need to be enabled when using an SBC or SIP ALG in conjunction with a remote SIP server.
Buffer SIP Calls ?	Also referred to as delayed paging. Device will buffer up to 4 minutes of audio then play back the recording after hang up.
Re-registration Interval (in seconds) ?	The SIP Re-registration interval (in seconds) is the SIP Registration lease time, also known as the expiry. The supported range is 30-3600 seconds. Enter up to 4 digits.
Unregister on Boot ?	When enabled, the device will send one registration with an expiry of 0 on boot.
Keep Alive Period ?	The minimum time in milliseconds between keep-alive packets sent for nat traversal. A value of 0 will disable keep alive packets.
SIP Strobe Settings	
Blink Strobe on Ring ?	When selected, the Strobe will blink a scene when ringing.
Scene ?	Select desired scene (only one may be chosen).
ADA Compliant ?	Strobe will blink ON at the specified brightness for 150ms then OFF for 350ms during the duration of the event.
Slow Fade ?	Strobe will increase in brightness from 0 to the specified brightness and back to 0 over the course of about 3.5 seconds during the duration of the event.

Table 2-17. SIP Page Parameters (continued)









































Web Page Item	Description
Fast Fade 	Strobe will increase in brightness from 0 to the specified brightness and back to 0 over the course of about 1.5 seconds during the duration of the event.
Slow Blink 	Strobe will blink ON at the specified brightness for one second then OFF for one second during the duration of the event.
Fast Blink 	Strobe will blink ON at the specified brightness then OFF five times per second during the duration of the event.
Color 	Select desired color (only one may be chosen).
Brightness 	How bright the strobe will blink when there is a SIP Call. This is the maximum brightness for “fade” type scenes.
Red 	The red LED value for SIP Call.
Green 	The green LED value for SIP Call.
Blue 	The blue LED value for SIP Call.
	Use this button to preview the strobe flashing behavior for the MWI Strobe Settings .
MWI Strobe Settings	
Blink Strobe on MWI 	When selected, the strobe will blink a scene when a voicemail is waiting for its extension.
Scene 	Select desired scene (only one may be chosen).
ADA Compliant 	Strobe will blink ON at the specified brightness for 150ms then OFF for 350ms during the duration of the event.
Slow Fade 	Strobe will increase in brightness from 0 to the specified brightness and back to 0 over the course of about 3.5 seconds during the duration of the event.
Fast Fade 	Strobe will increase in brightness from 0 to the specified brightness and back to 0 over the course of about 1.5 seconds during the duration of the event.
Slow Blink 	Strobe will blink ON at the specified brightness for one second then OFF for one second during the duration of the event.
Fast Blink 	Strobe will blink ON at the specified brightness then OFF five times per second during the duration of the event.
MWI Call Color 	Select desired color (only one may be chosen).
Brightness 	How bright the strobe will blink when there is a message waiting. This is the maximum brightness for “fade” type scenes.
Red 	The red LED value for MWI.
Green 	The green LED value for MWI.
Blue 	The blue LED value for MWI.
	Use this button to preview the strobe flashing behavior for the MWI Strobe Settings .
Nightringer Settings	

Table 2-17. SIP Page Parameters (continued)

Web Page Item	Description
Enable Nightringer ?	When Nightringer is enabled, the device will attempt to register a second extension with the SIP server. Any calls made to this extension will play a ringtone (corresponds to Night Ring on the Audiofiles page). By design, it is not possible to answer a call to the Nightringer extension.
SIP Server ?	Enter the SIP server address as an IPv4 address in dotted decimal notation or a fully qualified domain name. This parameter also becomes the host portion of the SIP-URI for the device's Nightringer extension on the SIP server. This field can accept entries of up to 255 characters in length.
Remote SIP Port ?	The Remote SIP Port is the port number the device will use as the destination port when sending SIP messages for the Nightringer extension. The default Remote SIP Port is 5060. The supported range is 0-65536. Enter up to 5 digits.
Local SIP Port ?	The Local SIP Port is the port number the device will use to receive SIP messages for the Nightringer extension. This value cannot be the same as the Local SIP Port for the primary extension. The default Local SIP Port is 5061. The supported range is 0-65536. Enter up to 5 digits.
Outbound Proxy ?	Enter the Outbound Proxy address as an IPv4 address in dotted decimal notation or a fully qualified domain name (FQDN). When an IP address is configured, the device will send all SIP messages to this IP address for the Nightringer extension. When an FQDN is configured, the device will run DNS NAPTR, SRV, and A queries on the FQDN to resolve an IP address to which it will send all SIP messages for the Nightringer extension. This field can accept entries of up to 255 characters in length.
Outbound Proxy Port ?	The Outbound Proxy Port is port number used as the destination port when sending SIP messages to the outbound proxy for the Nightringer extension. A value of 0 will default to 5060. The supported range is 0-65536. Enter up to 5 digits.
User ID ?	Specify the SIP User ID for the SIP server. This parameter becomes the user portion of the SIP-URI for the device's Nightringer extension. Enter up to 64 alphanumeric characters.
Authenticate ID ?	Specify the Authenticate ID for the SIP Server. This parameter is required for SIP registration authentication. Enter up to 64 alphanumeric characters.
Authenticate Password ?	Specify the Authenticate Password for the SIP Server. This parameter is required for SIP registration authentication. Enter up to 64 alphanumeric characters.
Re-registration Interval (in seconds) ?	The SIP Re-registration Interval (in seconds) is the SIP Registration lease time, also known as the expiry. The supported range is 30-3600 seconds. Enter up to 4 digits.
Nightringer Strobe Settings	
Blink Strobe on Nightring ?	When selected, the Strobe will blink a scene when the Nightringer is ringing.
Scene ?	Select desired scene (only one may be chosen).
ADA Compliant ?	Strobe will blink ON at the specified brightness for 150ms then OFF for 350ms during the duration of the event.

Table 2-17. SIP Page Parameters (continued)

Web Page Item	Description
Slow Fade 	Strobe will increase in brightness from 0 to the specified brightness and back to 0 over the course of about 3.5 seconds during the duration of the event.
Fast Fade 	Strobe will increase in brightness from 0 to the specified brightness and back to 0 over the course of about 1.5 seconds during the duration of the event.
Slow Blink 	Strobe will blink ON at the specified brightness for one second then OFF for one second during the duration of the event.
Fast Blink 	Strobe will blink ON at the specified brightness then OFF five times per second during the duration of the event.
Color 	Select desired color (only one may be chosen).
Brightness 	How bright the strobe will blink when the Nightringer is ringing. This is the maximum brightness for "fade" type scenes.
Red 	The red LED value for Nightringer.
Green 	The green LED value for Nightringer.
Blue 	The blue LED value for Nightringer.
	Use this button to preview the strobe flashing behavior for the Nightringer Strobe Settings .
RTP Settings	
RTP Port (even) 	Specify the port number used for the RTP stream after establishing a SIP call. This port number must be an even number and defaults to 10500. The supported range is 0-65536. Enter up to 5 digits.
Jitter Buffer 	Specify the size of the jitter buffer (in milliseconds) used for SIP calls. Valid values are 50-1000.
Call Disconnection	
Terminate Call After Delay 	Automatically terminate an active call after a given delay in seconds. A value of 0 will disable this function. Enter up to 8 digits.
Codec Selection	
Force Selected Codec 	When configured, this option will allow you to force the device to negotiate for the selected codec. Otherwise, the device will perform codec negotiation using the default list of supported codecs.
Codec 	Select the desired codec (only one may be chosen).
	Click the Save button to save your configuration settings. Note: You need to reboot for changes to take effect.
	Click on the Reboot button to reboot the system.
	Click on the Toggle Help button to see a short description of some of the web page items. First click on the Toggle Help button, and you will see a question mark () appear next to some of the web page items. Move the mouse pointer to hover over a question mark to see a short description of a specific web page item.

Note You must click on the **Save** button and then the **Reboot** button for the changes to take effect.

Note For specific server configurations, go to the following website address:

<http://www.cyberdata.net/connecting-to-ip-pbx-servers/>

2.3.8.1 Dial Out Extension Strings and DTMF Tones (using rfc2833)

On the **SIP Page**, dial out extensions support the addition of comma delimited pauses and sending additional DTMF tones (using rfc2833). The first comma will pause three seconds after a call is first established with a remote device. Subsequent commas will pause for 2 seconds. A pause of one second will be sent after each numerical digit.

Table 2-18. Examples of Dial-Out Extension Strings

Extension String	Resulting Action
302	Dial out extension 302 and establish a call
302,2	Dial out extension 302 and establish a call, wait 3 seconds then send the DTMF tone '2'
302,25,,4,,1	Dial out extension 302 and establish a call, wait 3 seconds then send the DTMF tone '2', send out DTMF tone 5, wait 6 seconds, send out DTMF tone 4, wait 4 seconds, send out DTMF tone 1

Note The maximum number of total characters in the dial-out field is 64.

2.3.8.2 Point-to-Point Configuration

When the device is set to not register with a SIP server (see [Figure 2-33](#)), it is possible to set the device to dial out to a single endpoint.

In this case, the dial-out extension should be the IP address of the remote device. The device can also receive Point-to-Point calls. The delayed DTMF functionality is available in the Point-to-Point Mode.

Note Receiving point-to-point SIP calls may not work with all phones.

Figure 2-33. SIP Page Set to Point-to-Point Mode

The screenshot shows the 'SIP Settings' page for the CyberData Paging Amplifier. The 'SIP' tab is selected in the top navigation bar. The page title is 'CyberData Paging Amplifier'. The 'SIP Settings' section includes the following fields and values:

- Enable SIP operation:
- Register with a SIP Server: (indicated by a red arrow)
- Use Cisco SRST:
- Primary SIP Server: 10.0.0.253
- Primary SIP User ID: 199
- Primary SIP Auth ID: 199
- Primary SIP Auth Password: *****
- Backup SIP Server 1: [Empty]
- Backup SIP User ID 1: [Empty]
- Backup SIP Auth ID 1: [Empty]
- Backup SIP Auth Password 1: [Empty]
- Backup SIP Server 2: [Empty]
- Backup SIP User ID 2: [Empty]
- Backup SIP Auth ID 2: [Empty]
- Backup SIP Auth Password 2: [Empty]
- Remote SIP Port: 5060
- Local SIP Port: 5060
- Outbound Proxy: [Empty]
- Outbound Proxy Port: 0
- Disable rport Discovery:
- Buffer SIP Calls:
- Re-registration Interval (in seconds): 360
- Unregister on Boot:
- Keep Alive Period: 10000

The 'Nightringer Settings' section includes:

- Enable Nightringer:
- SIP Server: 10.0.0.253
- Remote SIP Port: 5060
- Local SIP Port: 5061
- Outbound Proxy: [Empty]
- Outbound Proxy Port: 0
- User ID: 241
- Authenticate ID: 241
- Authenticate Password: *****
- Re-registration Interval (in seconds): 360

The 'Nightringer Strobe Settings' section includes:

- Blink Strobe on Nightringer:
- Scene: ADA
- Color: White
- Brightness: 100
- Red: 0
- Green: 0
- Blue: 0
- Preview button

The 'RTP Settings' section includes:

- RTP Port (even): 10500
- Jitter Buffer: 50

The 'Call Disconnection' section includes:

- Terminate Call after delay: 0

The 'Codec Selection' section includes:

- Force Selected Codec:
- Codec: PCMU (G.711, u-law)

The 'SIP Strobe Settings' section includes:

- Blink Strobe on Ring:
- Scene: ADA
- Color: White
- Brightness: 100
- Red: 0
- Green: 0
- Blue: 0
- Preview button

The 'MWI Strobe Settings' section includes:

- Blink Strobe on MWI:
- Scene: ADA
- Color: White
- Brightness: 100
- Red: 0
- Green: 0
- Blue: 0
- Preview button

At the bottom of the page are buttons for 'Save', 'Reboot', and 'Toggle Help'.

Device is set to NOT register with a SiP server

2.3.8.3 Delayed DTMF

On the **SIP** page the dial out extension supports the addition of comma delimited pauses and sending additional DTMF tones (using rfc2833). The first comma will pause three seconds after a call is first established with a remote device. Subsequent commas will pause for 2 seconds. A pause of one second will be sent after each numerical digit.

Table 2-19. Examples of Dial-Out Extension Strings

Extension String	Resulting Action
302	Dial out extension 302 and establish a call
302,2	Dial out extension 302 and establish a call, wait 3 seconds then send the DTMF tone '2'
302,25,,,4,,1	Dial out extension 302 and establish a call, wait 3 seconds then send the DTMF tone '2', send out DTMF tone 5, wait 6 seconds, send out DTMF tone 4, wait 4 seconds, send out DTMF tone 1

Note The maximum number of total characters in the dial-out field is 25.

2.3.9 Configure the Multicast Parameters

The **Multicast** page allows the device to join up to ten paging zones for receiving ulaw/alaw encoded RTP audio streams.

A paging zone can consist of one or many CyberData multicast group-enabled products. There is no limit to how many speakers can be in a given paging zone. Each multicast group is defined by a multicast address and port number.

Each multicast group is assigned a priority, allowing simultaneously arriving pages to be serviced based on importance. Multicast groups are compatible with IGMP through version 3. The device supports simultaneous SIP and Multicast.

1. Click on the **Multicast** menu button to open the **Multicast** page. See [Figure 2-34](#).

Figure 2-34. Multicast Page

Multicast Settings
 Enable Multicast Operation:
 Blink Strobe on Multicast:

Priority	Address	Port	Name	Buffer	Beep	Relay	Scene	Color	Brightness	Red	Green	Blue	
9	239.168.3.10	11000	Emergency	<input type="checkbox"/>	<input type="checkbox"/>	<input type="checkbox"/>	ADA	White	100	0	0	0	Preview
8	239.168.3.9	10000	MG8	<input type="checkbox"/>	<input type="checkbox"/>	<input type="checkbox"/>	Fast Blink	Red	100	255	0	0	Preview
7	239.168.3.8	9000	MG7	<input type="checkbox"/>	<input type="checkbox"/>	<input type="checkbox"/>	Slow Fade	Custom	100	150	255	80	Preview
6	239.168.3.7	8000	MG6	<input type="checkbox"/>	<input type="checkbox"/>	<input type="checkbox"/>	Fast Fade	Blue	100	0	0	255	Preview
5	239.168.3.6	7000	MG5	<input type="checkbox"/>	<input type="checkbox"/>	<input type="checkbox"/>	Off	White	100	0	0	0	Preview
4	239.168.3.5	6000	MG4	<input type="checkbox"/>	<input type="checkbox"/>	<input type="checkbox"/>	Slow Blink	Yellow	100	255	255	0	Preview
3	239.168.3.4	5000	MG3	<input type="checkbox"/>	<input type="checkbox"/>	<input type="checkbox"/>	Fast Blink	Violet	100	255	0	255	Preview
2	239.168.3.3	4000	MG2	<input type="checkbox"/>	<input type="checkbox"/>	<input type="checkbox"/>	Slow Blink	Green	100	0	255	0	Preview
1	239.168.3.2	3000	MG1	<input type="checkbox"/>	<input type="checkbox"/>	<input type="checkbox"/>	Fast Blink	Violet	100	255	0	255	Preview
0	239.168.3.1	2000	Background Music	<input type="checkbox"/>	<input type="checkbox"/>	<input type="checkbox"/>	Slow Blink	White	100	0	0	0	Preview

Polycorn Default Channel: 1
 Polycorn Priority Channel: 24
 Polycorn Emergency Channel: 25

SIP calls are considered priority 4.5
Port range can be from 2000-65535
Priority 9 is the highest and 0 is the lowest
A higher priority audio stream will always supersede a lower one
** You need to reboot for changes to take effect*







2. On the **Multicast** page, enter values for the parameters indicated in [Table 2-20](#).

Note The question mark icon (?) in the following table shows which web page items will be defined after the **Toggle Help** button is pressed.

Table 2-20. Multicast Page Parameters

Web Page Item	Description
Enable Multicast Operation	Enables or disables multicast operation.
Blink Strobe on Multicast ?	When selected, the Strobe will blink a scene when a multicast is received.
Priority	Indicates the priority for the multicast group. Priority 9 is the highest (emergency streams). 0 is the lowest (background music). SIP calls are considered priority 4.5 . See Section 2.3.9.1, "Assigning Priority" for more details.
Address	Enter the multicast IP Address for this multicast group (15 character limit).
Port	Enter the port number for this multicast group (5 character limit [range can be from 2000 to 65535]). Note: The multicast ports have to be even values. The webpage will enforce this restriction.
Name	Assign a descriptive name for this multicast group (25 character limit).
Buffer	Device will buffer up to four minutes of audio and then play back the recording after the multicast stream finishes or after the buffer is full.
Beep	When selected, the device will play a beep before multicast audio is sent.
Relay	When selected, the device will activate a relay before multicast audio is sent.
Scene ?	Select desired scene (only one may be chosen).
ADA Compliant ?	Strobe will blink ON at the specified brightness for 150ms then OFF for 350ms during the duration of the event.
Slow Fade ?	Strobe will increase in brightness from 0 to the specified brightness and back to 0 over the course of about 3.5 seconds during the duration of the event.
Fast Fade ?	Strobe will increase in brightness from 0 to the specified brightness and back to 0 over the course of about 1.5 seconds during the duration of the event.
Slow Blink ?	Strobe will blink ON at the specified brightness for one second then OFF for one second during the duration of the event.
Fast Blink ?	Strobe will blink ON at the specified brightness then OFF five times per second during the duration of the event.
Color ?	Select desired color (only one may be chosen).
Brightness ?	How bright the strobe will blink on a multicast page. This is the maximum brightness for "fade" type scenes.
Red ?	The red LED value for Multicast.
Green ?	The green LED value for Multicast.

Table 2-20. Multicast Page Parameters (continued)

Web Page Item	Description
Blue 	The blue LED value for Multicast.
Polycom Default Channel	When a default Polycom channel/group number is selected, the device will subscribe to the default channel for one-way group pages. Group Numbers 1-25 are supported. Or, select Disabled to disable this channel.
Polycom Priority Channel	When a priority Polycom channel/group number is selected, the device will subscribe to the priority channel for one-way group pages. Group Numbers 1-25 are supported. Or, select Disabled to disable this channel.
Polycom Emergency Channel	When an emergency Polycom channel/group number is selected, the device will subscribe to the default channel for one-way group pages. Group Numbers 1-25 are supported. Or, select Disabled to disable this channel.
	Use this button to preview the strobe flashing behavior for the Multicast Strobe Settings .
	Click the Save button to save your configuration settings. Note: You need to reboot for changes to take effect.
	Click on the Reboot button to reboot the system.
	Click on the Toggle Help button to see a short description of some of the web page items. First click on the Toggle Help button, and you will see a question mark () appear next to some of the web page items. Move the mouse pointer to hover over a question mark to see a short description of a specific web page item.

Note You must click on the **Save** button and then the **Reboot** button for the changes to take effect.

2.3.9.1 Assigning Priority

The device will prioritize simultaneous audio streams according to their priority in the list.

If both SIP and Multicast is enabled, SIP audio streams are considered priority **4.5**. SIP audio will interrupt multicast streams with priority **0** through **4** and will be interrupted by multicast streams with priority **5** through **9**.

During priority **9** multicast streams, the volume is set to maximum.

Note SIP calls, multicast streams, ring tones, ringback tones, and nightring tones are all prioritized.

Ringtones and Nightringtones

Ringtones all play at the same priority level. This means that it is possible to have a nightring tone and a normal ringtone playing at the same time.

2.3.10 Configure the Sensor Page Parameters

The door sensor (pins 1 and 2) on the terminal block can be used to monitor a door's open or closed state. There is an option on the [Sensor Page](#) to trigger on an open or short condition on these pins. The door sensor alarm will be activated when the [Sensor Timeout \(in seconds\)](#) parameter has been met.

Each sensor can trigger up to five different actions:

- Flash the LED until the sensor is deactivated (roughly 10 times/second)
- Activate the relay until the sensor is deactivated
- Loop an audio file out of the speaker until the sensor is deactivated
- Call an extension and establish two way audio
- Call an extension and play a pre-recorded audio file

Note Calling a preset extension can be set up as a point-to-point call, but currently can't send delayed DTMF tones.

1. Click **Sensor** menu button to open the [Sensor Page](#) ([Figure 2-35](#)).

Figure 2-35. Sensor Page

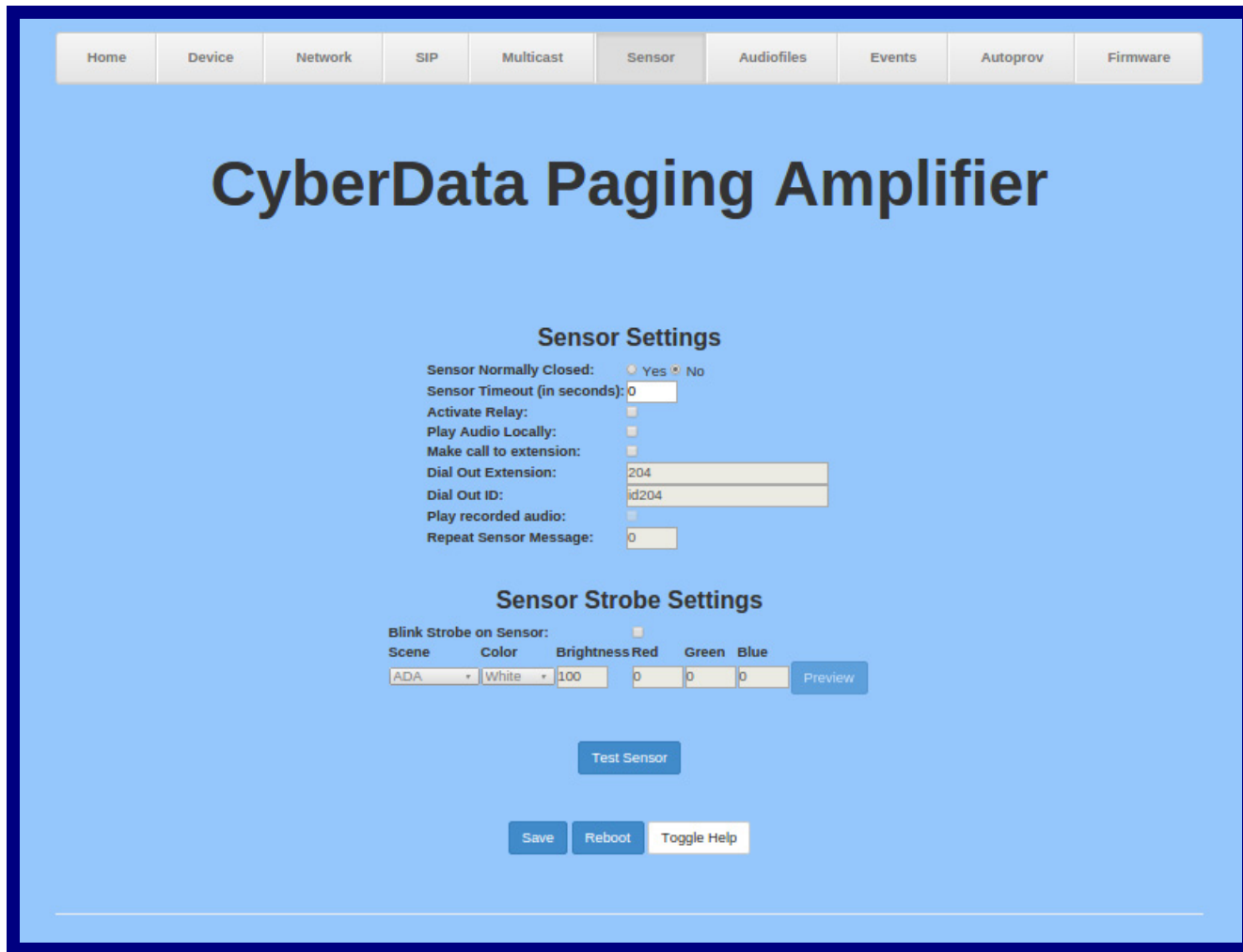













2. On the **Sensor** page, enter values for the parameters indicated in [Table 2-21](#).

Note The question mark icon (?) in the following table shows which web page items will be defined after the **Toggle Help** button is pressed.

Table 2-21. Sensor Page Parameters

Web Page Item	Description
Sensor Settings	
Sensor Normally Closed ?	Select the inactive state of the sensor. The sensor is also known as the Sense Input on the device's terminal block.
Sensor Timeout (in seconds) ?	The time (in seconds) the device will wait before it performs an action when the on-board door sensor is activated. The action(s) performed are based on the configured Sensor Settings below. Enter up to 5 digits.
Activate Relay ?	When selected, the device's on-board relay will be activated until the on-board sensor is deactivated.
Play Audio Locally ?	When selected, the device will loop an audio file out of the speaker until the sensor is deactivated.
Make call to extension ?	When selected, the device will call an extension when the on-board door sensor is activated. Use the Dial Out Extension field below to specify the extension the device will call.
Dial Out Extension ?	Specify the extension the device will call when the on-board sensor is activated. Enter up to 64 alphanumeric characters.
Dial Out ID ?	An additional Caller identification string added to outbound calls. Enter up to 64 alphanumeric characters.
Play recorded audio ?	When selected, the device will call the Dial Out Extension and play an audio file to the phone answering the SIP call (corresponds to Sensor Triggered on the Audiofiles Page page).
Repeat Sensor Message ?	The number of times to repeat the audio message through the local speaker or to the remote endpoint. A value of 0 will repeat the message while the sensor is active. Enter a value from 0-65536.
Sensor Strobe Settings	
Blink Strobe on Sensor ?	When selected, the Strobe will blink a scene when the sensor is triggered.
Scene ?	Select desired scene (only one may be chosen).
ADA Compliant ?	Strobe will blink ON at the specified brightness for 150ms then OFF for 350ms during the duration of the event.
Slow Fade ?	Strobe will increase in brightness from 0 to the specified brightness and back to 0 over the course of about 3.5 seconds during the duration of the event.
Fast Fade ?	Strobe will increase in brightness from 0 to the specified brightness and back to 0 over the course of about 1.5 seconds during the duration of the event.
Slow Blink ?	Strobe will blink ON at the specified brightness for one second then OFF for one second during the duration of the event.

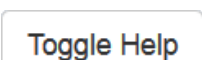
Table 2-21. Sensor Page Parameters (continued)

Web Page Item	Description
Fast Blink 	Strobe will blink ON at the specified brightness then OFF five times per second during the duration of the event.
Color 	Select desired color (only one may be chosen).
Brightness 	How bright the strobe will blink when the sensor is triggered. This is the maximum brightness for “fade” type scenes.
Red 	The red LED value for Sensor.
Green 	The green LED value for Sensor.
Blue 	The blue LED value for Sensor.
	Click the Test Sensor button to test the sensor.
	Use this button to preview the strobe flashing behavior for the Sensor Strobe Settings .
	Click the Save button to save your configuration settings. Note: You need to reboot for changes to take effect.
	Click on the Reboot button to reboot the system.
	Click on the Toggle Help button to see a short description of some of the web page items. First click on the Toggle Help button, and you will see a question mark () appear next to some of the web page items. Move the mouse pointer to hover over a question mark to see a short description of a specific web page item.

Note You must click on the **Save** button for the changes to take effect.

2.3.11 Configure the Audiofiles Page Parameters

The **Audiofiles** page is used to add custom audio to the board. User uploaded audio will take precedence over the audio files shipped with the device.

1. Click on the **Audiofiles** menu button to open the **Audiofiles** page (Figure 2-36).

Figure 2-36. Audiofiles Page

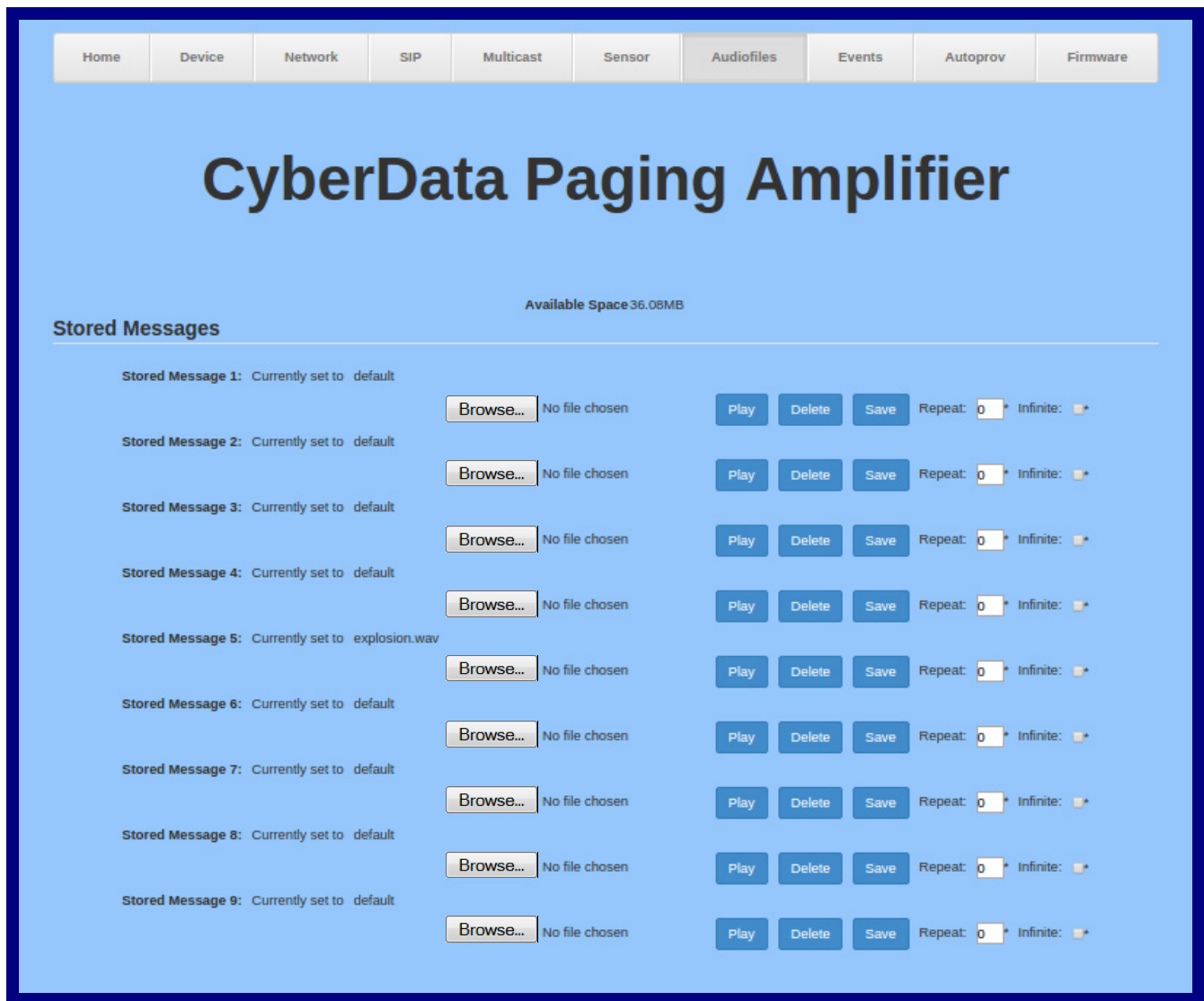

Figure 2-37. Audiofiles Page

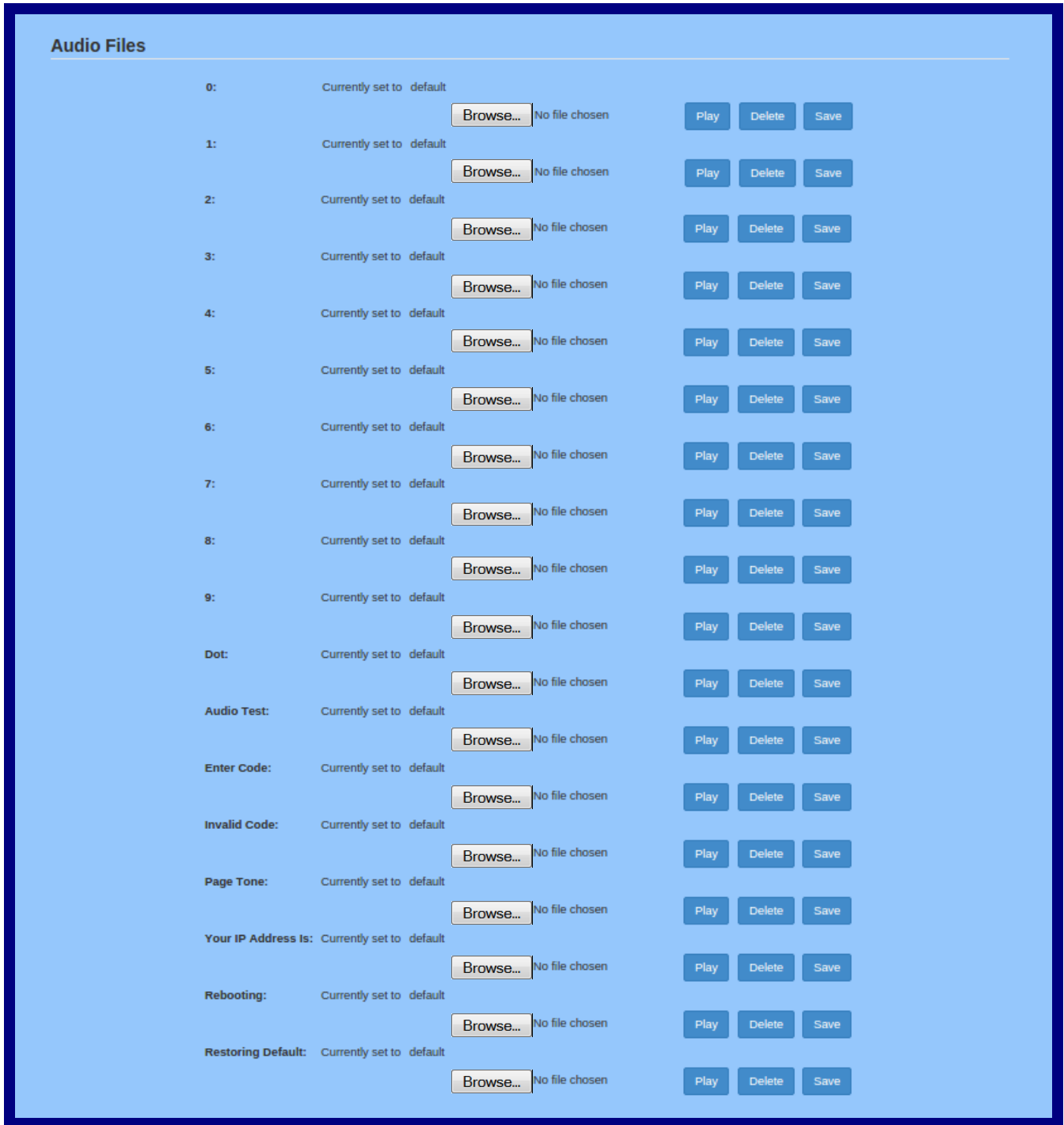

Figure 2-38. Audiofiles Page

The screenshot shows a web interface for configuring audio files. It is organized into two main sections: **Ring Tone** and **Menu Audio Files**.

Ring Tone Section:

- Ring Tone:** Currently set to default. Includes a **Browse...** button, a status indicator "No file chosen", and **Play**, **Delete**, and **Save** buttons.
- Sensor Triggered:** Currently set to default. Includes a **Browse...** button, a status indicator "No file chosen", and **Play**, **Delete**, and **Save** buttons.
- Night Ring:** Currently set to default. Includes a **Browse...** button, a status indicator "No file chosen", and **Play**, **Delete**, and **Save** buttons.

Menu Audio Files Section:

- Cancel:** Currently set to default. Includes a **Browse...** button, a status indicator "No file chosen", and **Play**, **Delete**, and **Save** buttons.
- Currently Playing:** Currently set to default. Includes a **Browse...** button, a status indicator "No file chosen", and **Play**, **Delete**, and **Save** buttons.
- Invalid Entry:** Currently set to default. Includes a **Browse...** button, a status indicator "No file chosen", and **Play**, **Delete**, and **Save** buttons.
- Page:** Currently set to default. Includes a **Browse...** button, a status indicator "No file chosen", and **Play**, **Delete**, and **Save** buttons.
- Play Stored Message:** Currently set to default. Includes a **Browse...** button, a status indicator "No file chosen", and **Play**, **Delete**, and **Save** buttons.
- Pound (#):** Currently set to default. Includes a **Browse...** button, a status indicator "No file chosen", and **Play**, **Delete**, and **Save** buttons.
- Press:** Currently set to default. Includes a **Browse...** button, a status indicator "No file chosen", and **Play**, **Delete**, and **Save** buttons.
- Stored Message:** Currently set to default. Includes a **Browse...** button, a status indicator "No file chosen", and **Play**, **Delete**, and **Save** buttons.
- Through:** Currently set to default. Includes a **Browse...** button, a status indicator "No file chosen", and **Play**, **Delete**, and **Save** buttons.
- To:** Currently set to default. Includes a **Browse...** button, a status indicator "No file chosen", and **Play**, **Delete**, and **Save** buttons.





2. On the **Audiofiles** page, enter values for the parameters indicated in [Table 2-22](#).

Note The question mark icon (?) in the following table shows which web page items will be defined after the **Toggle Help** button is pressed.

Table 2-22. Audiofiles Page Parameters

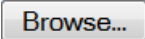
Web Page Item	Description
Available Space	Shows the space available for the user to save custom audio files if they want to change the message when the door or sensor is triggered.
Stored Messages	
Stored Message 1 through 9	<p>Stored Message 1 corresponds to the message played after pressing 1 on a phone keypad.</p> <p>Stored Message 2 corresponds to the message played after pressing 2 on a phone keypad.</p> <p>Stored Message 3 corresponds to the message played after pressing 3 on a phone keypad.</p> <p>Stored Message 4 corresponds to the message played after pressing 4 on a phone keypad.</p> <p>Stored Message 5 corresponds to the message played after pressing 5 on a phone keypad.</p> <p>Stored Message 6 corresponds to the message played after pressing 6 on a phone keypad.</p> <p>Stored Message 7 corresponds to the message played after pressing 7 on a phone keypad.</p> <p>Stored Message 8 corresponds to the message played after pressing 8 on a phone keypad.</p> <p>Stored Message 9 corresponds to the message played after pressing 9 on a phone keypad.</p>
Audio Files	
0-4	<p>The name of the audio configuration option is the same as the spoken audio that plays on the board (24 character limit).</p> <p>'0' corresponds to the spoken word "zero."</p> <p>'1' corresponds to the spoken word "one."</p> <p>'2' corresponds to the spoken word "two."</p> <p>'3' corresponds to the spoken word "three."</p> <p>'4' corresponds to the spoken word "four."</p>
5-9	<p>The name of the audio configuration option is the same as the spoken audio that plays on the board (24 character limit).</p> <p>'5' corresponds to the spoken word "five."</p> <p>'6' corresponds to the spoken word "six."</p> <p>'7' corresponds to the spoken word "seven."</p> <p>'8' corresponds to the spoken word "eight."</p> <p>'9' corresponds to the spoken word "nine."</p>
Dot	Corresponds to the spoken word "dot." (24 character limit)
Audio Test	Corresponds to the message " <i>This is the CyberData IP speaker test message...</i> " (24 character limit)
Enter Code	Corresponds to the message "Enter Code" (24 character limit).
Invalid Code	Corresponds to the message "Invalid Code" (24 character limit).
Page Tone	Corresponds to a simple tone used for beep on initialization and beep on page (24 character limit).
Your IP Address is	Corresponds to the message "Your IP address is.." (24 character limit).
Rebooting	Corresponds to the spoken word "Rebooting" (24 character limit).

Table 2-22. Audiofiles Page Parameters (continued)

Web Page Item	Description
Restoring Default	Corresponds to the message "Restoring default" (24 character limit).
Ring Tone	This is the tone that plays when set to ring when receiving a call (24 character limit).
Sensor Triggered	Corresponds to the message "Sensor Triggered" (24 character limit).
Night Ring	Specifies the ringtone for nightring. By default this parameter uses the same audio file that is selected for the Ring Tone parameter.
Menu Audio Files	Menu Audio Files are user-uploadable messages that create the audio menu played to the caller.
Cancel	Corresponds to the word "Cancel" used in the audio menu played to the caller. (24 character limit).
Currently Playing	Corresponds to the words "Currently Playing" used in the audio menu played to the caller. (24 character limit).
Invalid Entry	Corresponds to the words "Invalid Entry" used in the audio menu played to the caller. (24 character limit).
Page	Corresponds to the word "Page" used in the audio menu played to the caller. (24 character limit).
Play Stored Message	Corresponds to the words "Play Stored Message" used in the audio menu played to the caller. (24 character limit).
Pound (#)	Corresponds to whatever word or phrase the user wishes to call the pound key in the audio menu played to the caller (24 character limit).
Press	Corresponds to the word "Press" used in the audio menu played to the caller. (24 character limit).
Stored Message	Corresponds to the words "Stored Message" used in the audio menu played to the caller. (24 character limit).
Through	Corresponds to the word "Through" used in the audio menu played to the caller. (24 character limit).
To	Corresponds to the word "To" used in the audio menu played to the caller. (24 character limit).
	Click on the Browse button to navigate to and select an audio file.
	The Play button will play that audio file.
	The Delete button will delete any user uploaded audio and restore the stock audio file.
	The Save button will download a new user audio file to the board once you've selected the file by using the Browse button. The Save button will delete any pre-existing user-uploaded audio files.

2.3.11.1 User-created Audio Files

User created audio files should be saved in the following format:

RIFF (little-endian) data, WAVE audio, Microsoft PCM, 16 bit, mono 8000 Hz

You can use the free utility *Audacity* to convert audio files into this format. See [Figure 2-39](#) through [Figure 2-41](#).

Figure 2-39. Audacity 1

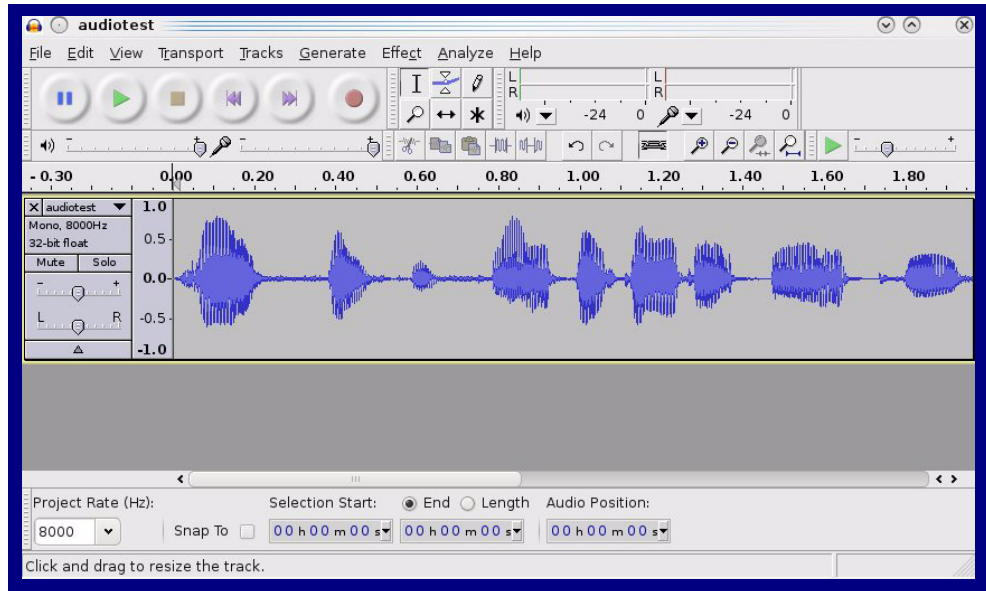
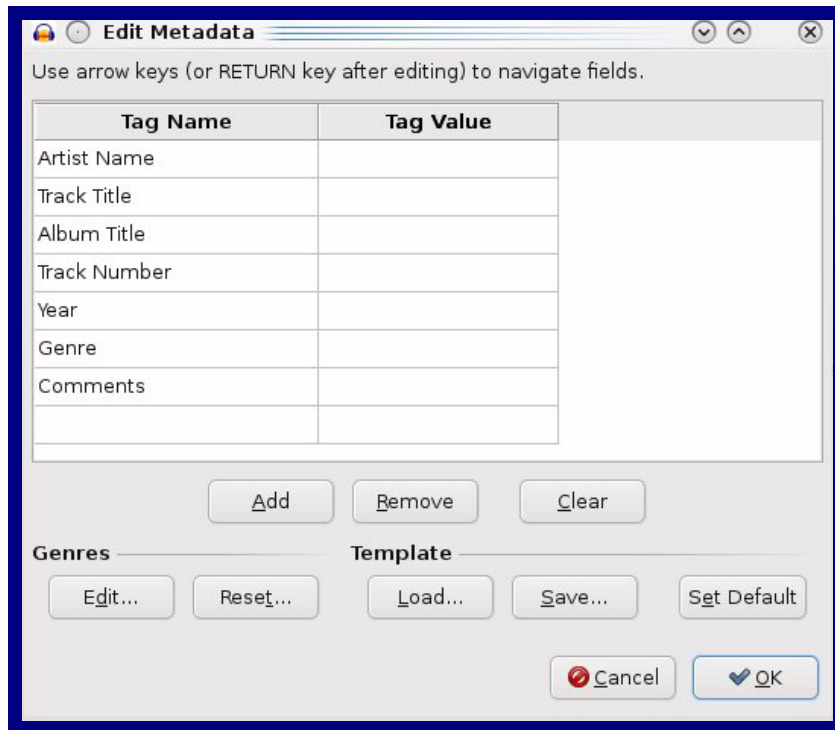

Figure 2-40. Audacity 2



When you export an audio file with Audacity, save the output as:

- **WAV (Microsoft) signed 16 bit PCM.**

Figure 2-41. WAV (Microsoft) signed 16 bit PCM

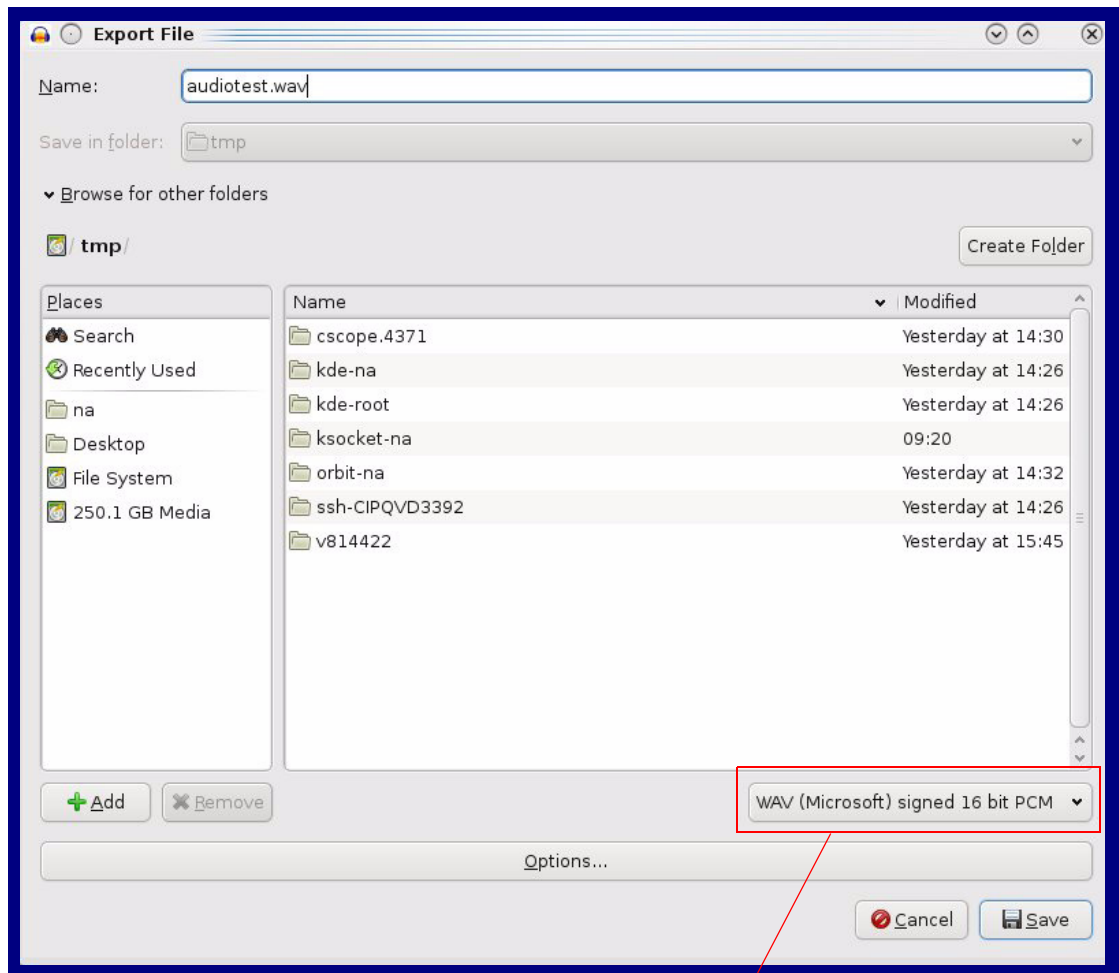

WAV (Microsoft) signed 16 bit PCM

2.3.12 Configure the Events Parameters

The **Events** page specifies a remote server that can be used to receive HTTP POST events when actions take place on the board.

1. Click on the **Events** menu button to open the **Events** page (Figure 2-42).

Figure 2-42. Event Page

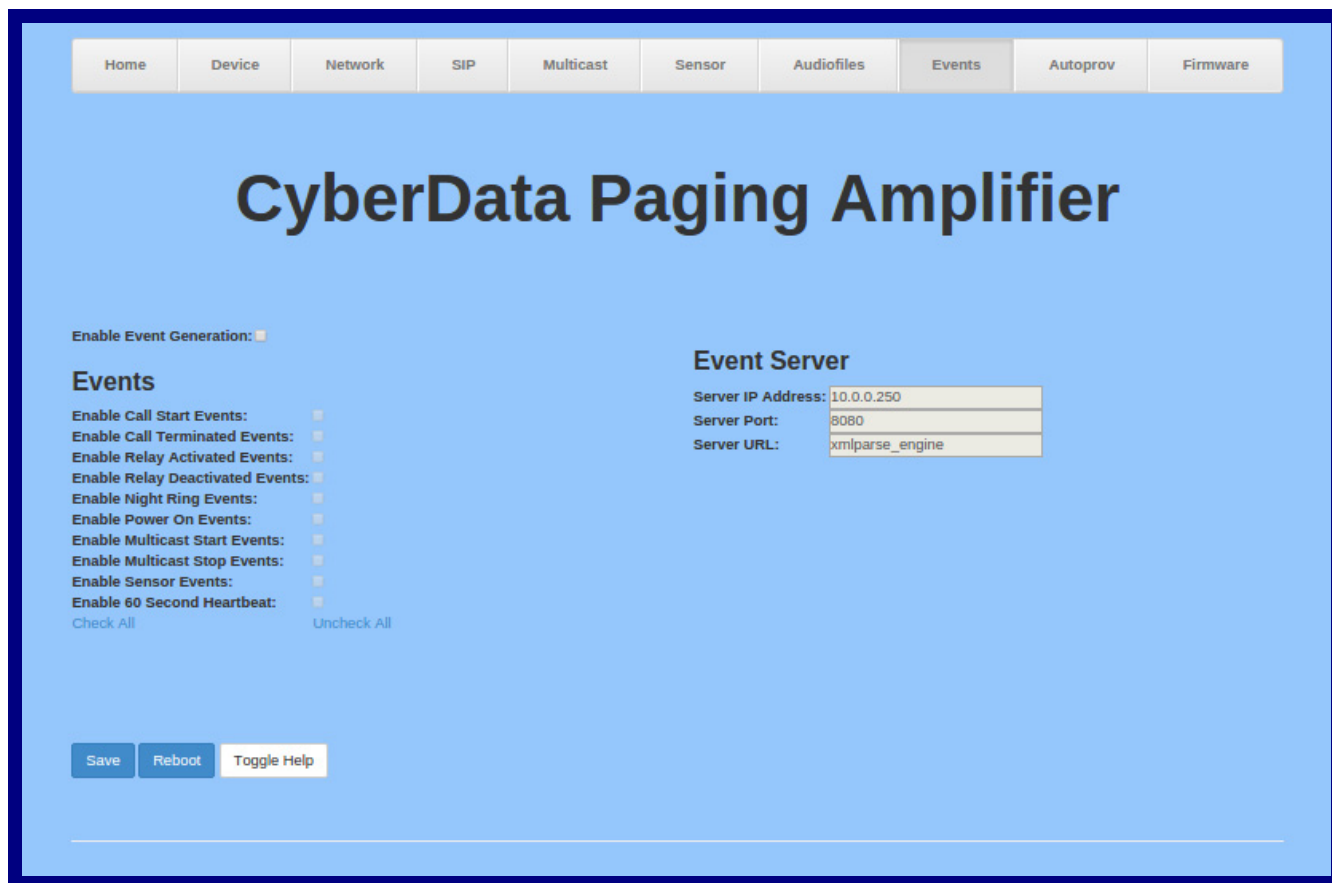

2. On the **Events** page, enter values for the parameters indicated in [Table 2-23](#).

Note The question mark icon (?) in the following table shows which web page items will be defined after the **Toggle Help** button is pressed.

Table 2-23. Events Page Parameters



Web Page Item	Description
Enable Event Generation ?	The device will send HTTP POST events to the specified remote server and port number whenever a certain action takes place. Select an event type below to generate an HTTP POST event.
Events	
Enable Call Start Events ?	When selected, the device will report the start of a SIP call.
Enable Call Terminated Events ?	When selected, the device will report the end of a SIP call.
Enable Relay Activated Events ?	When selected, the device will report relay activation.
Enable Relay Deactivated Events ?	When selected, the device will report relay deactivation.
Enable Night Ring Events ?	When selected, the device will report when it starts ringing upon an incoming SIP call to the Nightringer extension. As a reminder, the Nightringer extension always rings upon an incoming SIP call and it is not possible to alter this behavior.
Enable Power On Events ?	When selected, the device will report when it boots.
Enable Multicast Start Events ?	When selected, the device will report when the device starts playing a multicast audio stream.
Enable Multicast Stop Events ?	When selected, the device will report when the device stops playing a multicast audio stream.
Enable Sensor Events ?	When selected, the device will report when the on-board sensor is activated.
Enable 60 Second Heartbeat Events ?	When enabled, the device will report a Heartbeat event every 60 seconds. SIP registration is not required to generate Heartbeat events.
Check All	Click on Check All to select all of the events on the page.
Uncheck All	Click on Uncheck All to de-select all of the events on the page.
Event Server	
Server IP Address ?	The IPv4 address of the event server in dotted decimal notation.
Server Port ?	Specify the event server port number. The supported range is 0-65536. Enter up to 5 digits.
Server URL ?	Generally, the destination URL is the name of the application that receives the events and the string in the HTTP POST command. It can be a script used to parse and process the HTTP POST events. Enter up to 127 characters.
	Click the Save button to save your configuration settings. Note: You need to reboot for changes to take effect.
	Click on the Reboot button to reboot the system.

Table 2-23. Events Page Parameters(continued)

Web Page Item	Description
	Click on the Toggle Help button to see a short description of some of the web page items. First click on the Toggle Help button, and you will see a question mark (?) appear next to some of the web page items. Move the mouse pointer to hover over a question mark to see a short description of a specific web page item.

Note You must click on the **Save** button and then the **Reboot** button for the changes to take effect.

2.3.12.1 Example Packets for Events

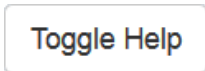
The server and port are used to point to the listening server and the 'Remote Event Server URL' is the destination URL (typically the script running on the remote server that's used to parse and process the POST events).

Note The XML is URL-encoded before transmission so the following examples are not completely accurate.

Here are example packets for every event:

```
POST xmlparse_engine HTTP/1.1
Host: 10.0.3.79
User-Agent: CyberData/1.0.0
Content-Length: 197
Content-Type: application/x-www-form-urlencoded

<?xml version="1.0" encoding="ISO-8859-1"?>
<cyberdata NAME='CyberData Device' MAC='0020f70015b6'>
<event>POWERON</event>
</cyberdata>
```

```
POST xmlparse_engine HTTP/1.1
Host: 10.0.3.79
User-Agent: CyberData/1.0.0
Content-Length: 199
Content-Type: application/x-www-form-urlencoded

<?xml version="1.0" encoding="ISO-8859-1"?>
<cyberdata NAME='CyberData Device' MAC='0020f70015b6'>
<event>HEARTBEAT</event>
</cyberdata>
```

```
POST xmlparse_engine HTTP/1.1
Host: 10.0.3.79
User-Agent: CyberData/1.0.0
Content-Length: 196
Content-Type: application/x-www-form-urlencoded

<?xml version="1.0" encoding="ISO-8859-1"?>
<cyberdata NAME='CyberData Device' MAC='0020f70015b6'>
<event>BUTTON</event>
</cyberdata>
```

```
POST xmlparse_engine HTTP/1.1
Host: 10.0.3.79
User-Agent: CyberData/1.0.0
Content-Length: 201
Content-Type: application/x-www-form-urlencoded

<?xml version="1.0" encoding="ISO-8859-1"?>
<cyberdata NAME='CyberData Device' MAC='0020f70015b6'>
<event>CALL_ACTIVE</event>
</cyberdata>
POST xmlparse_engine HTTP/1.1
Host: 10.0.3.79
```

```
User-Agent: CyberData/1.0.0
Content-Length: 205
Content-Type: application/x-www-form-urlencoded

<?xml version="1.0" encoding="ISO-8859-1"?>
<cyberdata NAME='CyberData Device' MAC='0020f70015b6'>
<event>CALL_TERMINATED</event>
</cyberdata>

POST xmlparse_engine HTTP/1.1
Host: 10.0.3.79
User-Agent: CyberData/1.0.0
Content-Length: 197
Content-Type: application/x-www-form-urlencoded

<?xml version="1.0" encoding="ISO-8859-1"?>
<cyberdata NAME='CyberData Device' MAC='0020f70015b6'>
<event>RINGING</event>
</cyberdata>

POST xmlparse_engine HTTP/1.1
Host: 10.0.3.79
User-Agent: CyberData/1.0.0
Content-Length: 234
Content-Type: application/x-www-form-urlencoded

<?xml version="1.0" encoding="ISO-8859-1"?>
<cyberdata NAME='CyberData Device' MAC='0020f70015b6'>
<event>MULTICAST_START</event>
<index>8</index>
</cyberdata>

POST xmlparse_engine HTTP/1.1
Host: 10.0.3.79
User-Agent: CyberData/1.0.0
Content-Length: 233
Content-Type: application/x-www-form-urlencoded

<?xml version="1.0" encoding="ISO-8859-1"?>
<cyberdata NAME='CyberData Device' MAC='0020f70015b6'>
<event>MULTICAST_STOP</event>
<index>8</index>
</cyberdata>

POST xmlparse_engine HTTP/1.1
Host: 10.0.3.79
User-Agent: CyberData/1.0.0
Content-Length: 234
Content-Type: application/x-www-form-urlencoded
<?xml version="1.0" encoding="ISO-8859-1"?>
<cyberdata NAME='CyberData Device' MAC='0020f70015b6'>
<event>RELAY_ACTIVATED</event>
</cyberdata>
POST xmlparse_engine HTTP/1.1
Host: 10.0.3.79
```

```
User-Agent: CyberData/1.0.0
Content-Length: 234
Content-Type: application/x-www-form-urlencoded
<?xml version="1.0" encoding="ISO-8859-1"?>
<cyberdata NAME='CyberData Device' MAC='0020f70015b6'>
<event>RELAY_DEACTIVATED</event>
</cyberdata>
```

```
POST xmlparse_engine HTTP/1.1
Host: 10.0.3.79
User-Agent: CyberData/1.0.0
Content-Length: 234
Content-Type: application/x-www-form-urlencoded
<?xml version="1.0" encoding="ISO-8859-1"?>
<cyberdata NAME='CyberData Device' MAC='0020f70015b6'>
<event>NIGHTRINGING</event>
</cyberdata>
```

2.3.13 Configure the Autoprovisioning Parameters

Autoprovisioning can be used to automatically configure your device. The autoprovisioning file is an xml file with the device configuration. Values found in this file will override values stored in on-board memory.

Note By default, the device will try to set up its configuration with autoprovisioning.

1. Click the **Autoprov** menu button to open the **Autoprovisioning** page. See [Figure 2-43](#).

Figure 2-43. Autoprovisioning Page

The screenshot shows the 'Autoprov' configuration page for a CyberData Paging Amplifier. At the top, there is a navigation menu with buttons for Home, Device, Network, SIP, Multicast, Sensor, Audiofiles, Events, Autoprov (selected), and Firmware. The main heading is 'CyberData Paging Amplifier'. Below this, there are several configuration fields: 'Disable Autoprovisioning:' with a checked checkbox, 'Autoprovisioning Server:' with a text input field, 'Autoprovisioning Filename:' with a text input field, 'Use ftp:' with a checked checkbox, 'Username:' with a text input field, 'Password:' with a text input field, 'Autoprovisioning autoupdate (in minutes):' with a numeric input field set to 0, 'Autoprovision at time (HHMMSS):' with a text input field, and 'Autoprovision when idle (in minutes > 10):' with a numeric input field set to 0. Below these fields, there is explanatory text: 'See the manual to learn how to use autoprovisioning to configure your device.', 'Autoprovisioning happens on boot.', 'The device will first look for a configured server address and filename.', and 'If these haven't been configured, it will look for an autoprovisioning server in your list of DHCP options and try to download '0002c18100b5.xml' and if this fails, '000000cd.xml'.'. At the bottom of the configuration section, there are three buttons: 'Save', 'Reboot', and 'Toggle Help'. Below this is a 'Download Template' button. The bottom section is titled 'Autoprovisioning log' and contains a scrollable text area with the following log entries: '00:00 Autoprovisioning Device...', '00:00 Autoprov found option 43 in DHCP server="http://chalmers.cyberdata.net"', '00:00 Autoprov looking for 0002c18100b5.xml at http://chalmers.cyberdata.net', '00:00 Autoprov looking for 000000cd.xml at http://chalmers.cyberdata.net', '00:00 Failed to fetch autoprov file', '00:00 Autoprov found option 72 in DHCP server="10.0.1.118"', '00:00 Autoprov looking for 0002c18100b5.xml at 10.0.1.118', '00:00 Autoprov looking for 000000cd.xml at 10.0.1.118', '00:00 Failed to fetch autoprov file', and '00:00 Autoprov found option 150 in DHCP server="10.0.5.120"'. The log area has a scrollbar on the right side.

- On the **Autoprovisioning** page, you may enter values for the parameters indicated in [Table 2-24](#).

Note The question mark icon (?) in the following table shows which web page items will be defined after the **Toggle Help** button is pressed.

Table 2-24. Autoprovisioning Page Parameters





Web Page Item	Description
Disable Autoprovisioning ?	Prevent the device from automatically trying to download a configuration file. See Section 2.3.13.1, "Autoprovisioning" for more information.
Autoprovisioning Server ?	Enter the IPv4 address of the provisioning server in dotted decimal notation.
Autoprovisioning Filename ?	<p>The autoprovisioning filename is the configuration filename. The default autoprovisioning filename is in the format of <mac address>.xml.</p> <p>Supported filename extensions are .txt, and .xml. The current filename is denoted by an asterisk at the bottom of the Autoprovisioning Page. Enter up to 256 characters.</p> <p>A file may have any name with an xml extension. If a file name is entered, the device will look for the specified file name, and only that file.</p>
Use tftp ?	The device will use TFTP (instead of http) to download autoprovisioning files.
Username ?	The username used to authenticate with an autoprovisioning server. Leave this field blank to disable authentication.
Password ?	The password used to authenticate with an autoprovisioning server. Leave this field blank to disable authentication.
Autoprovisioning Autoupdate (in minutes) ?	<p>The reoccurring time (in minutes) the device will wait before checking for new autoprovisioning files. Enter up to 6 digits. A value of 0 will disable this option.</p> <p>Note: To use the auto update options, enable the Set Time with NTP Server on boot setting on the Device Page (see Table 2-11).</p>
Autoprovision at time (HHMMSS) ?	<p>The time of day the device will check for a new autoprovisioning file. The time must be 6 characters in length and in HHMMSS format. An empty value will disable this option.</p> <p>Note: To use the auto update options, enable the Set Time with NTP Server on boot setting on the Device Page (see Table 2-11).</p>
Autoprovision when idle (in minutes > 10) ?	<p>The idle time (in minutes greater than 10) after which the device will check for a new autoprovisioning file. Enter up to 6 digits. A value of 0 will disable this option.</p> <p>Note: To use the auto update options, enable the Set Time with NTP Server on boot setting on the Device Page (see Table 2-11).</p>
	<p>Click the Save button to save your configuration settings.</p> <p>Note: You need to reboot for changes to take effect.</p>

Table 2-24. Autoprovisioning Page Parameters (continued)

Web Page Item	Description
	Click on the Reboot button to reboot the system.
	Click on the Toggle Help button to see a short description of some of the web page items. First click on the Toggle Help button, and you will see a question mark (?) appear next to some of the web page items. Move the mouse pointer to hover over a question mark to see a short description of a specific web page item.
	Press the Download Template button to create an autoprovisioning file for the device. See Section 2.3.13.3, "Download Template Button"
Autoprovisioning log	The autoprovisioning log provides information about the latest autoprovisioning attempt (i.e. dhcp options and server accessed and files parsed or not found).

Note You must click on the **Save** button and then the **Reboot** button for the changes to take effect.

2.3.13.1 Autoprovisioning

On boot, the device will look for an autoprovisioning server configured on the [Autoprovisioning Page](#) or specified as a DHCP option. When it finds a server, it will try to download the following (in order of preference):

1. The file configured on the autoprovisioning page.
2. A file named according to it's mac address (for example: 0020f7350058.xml).
3. The file 000000cd.xml

The file can be hosted using a standard web server (like apache, IIS, or nginx), and the device can download over SSL. The file server can be an ipv4 address in dotted decimal notation or a fully qualified domain name.

By default, the device will get its autoprovisioning server from the DHCP options. See [Section 2.3.13.2, "Sample dhcpd.conf"](#) for an example of how to configure dhcpd to offer autoprovisioning server addresses. If multiple options are set, the device will attempt to download autoprovisioning files from every server.

The DHCP option determines the protocol used to download the autoprovisioning file. The device looks for DHCP options in the following order:

1. Option 43 - a FQDN or an IP address to an http server
2. Option 72 - an IP address to an http server
3. Option 150 - an IP address to a tftp server
4. Option 66 - an IP address to a tftp server or if the entry starts with 'http', a FQDN to a http server.

You can download an auto provisioning template file from the [Auto provisioning Page](#) using the **Download Template** button (see [Table 2-24](#)). This file contains every configuration option that can be set on the board.

Auto provisioning files can contain the whole configuration or a subset of this file. The first auto provisioning file can also contain links to other auto provisioning files.

The <MiscSettings> section contains some examples of additional auto provisioning files:

```
<MiscSettings>
  <DeviceName>CyberData Device</DeviceName>
<!-- <AutoprovFile>common.xml</AutoprovFile>-->
<!-- <AutoprovFile>sip_reg [macaddress] .xml</AutoprovFile>-->
<!-- <AutoprovFile>audio [macaddress] </AutoprovFile>-->
<!-- <AutoprovFile>device [macaddress] .xml</AutoprovFile>-->
</MiscSettings>
```

After downloading the first auto provisioning file, the device will step through up to twenty additional <AutoprovFile> entries and try to download these files from the same server.

When the device finds a filename with the string **[macaddress]**, it will replace this string with the mac address.

As an example, the user has configured option 43 on their DHCP server to “http://example.com,” and on their server, they have a file named **0020f7123456.xml** (the same as the mac address of the device).

The file 0020f7123456.xml contains:

```
<?xml version="1.0" encoding="utf-8" ?>
<specific>
  <MiscSettings>
    <DeviceName>Newname</DeviceName>
    <AutoprovFile>common.xml</AutoprovFile>
    <AutoprovFile>sip_reg[macaddress].xml</AutoprovFile>
    <AutoprovFile>audio[macaddress]</AutoprovFile>
    <AutoprovFile>device.xml</AutoprovFile>
  </MiscSettings>
</specific>
```

1. The device will first set its name to 'Newname'.
2. It will try to download <http://example.com/common.xml>.
3. It will try to download http://example.com/sip_reg0020f7123456.xml.
4. It will try to download <http://example.com/audio0020f7123456>.
5. It will try to download <http://example.com/device.xml>.

The device is reconfigured every time it downloads a new file so if two files configure the same option the last one will be the one that is saved.

It is possible to autoprovision autoprovisioning values (for example, to disable autoprovisioning or to configure a time to check for new files).

Checking for New
Autoprovisioning
Files after Boot

The device will always check for an autoprovisioning files on boot but it can be configured to also check after a periodic delay, when idle, or at a specified time. When one of these options is set, the device will download its autoprovisioning files again, and if it finds any differences from the files it downloaded on boot, it will force a reboot and reconfigure.

The
 Autoprovisioning
 Filename

The autoprovisioning filename can contain a file, a file path, or a directory.

Table 2-25. Autoprovisioning File Name

Autoprovisioning Filename	Autoprovisioning Server	File Downloaded
config.xml	10.0.1.3	10.0.1.3/config.xml
/path/to/config.xml	10.0.1.3	10.0.1.3/path/to/config.xml
subdirectory/path/	10.0.1.3	10.0.1.3/subdirectory/path/0020f7020002.xml

TFTP options may not support subdirectories. If a directory is set in the filename field, firmware and audio files will also be downloaded from this subdirectory.

If the filename ends with a forward slash “/,” the device will treat it as a subdirectory.

For example:

The autoprovisioning server is set to “https://www.example.com”

The autoprovisioning filename is set to “cyberdata/”

On boot, the device will try to download:

https://www.example.com/cyberdata/0020f7123456.xml

...and if this fails:

https://www.example.com/cyberdata/000000cd.xml

Audio files and firmware files will also add “cyberdata” to the URL before downloading.

```

Autoprovisioning <FirmwareSettings>
Firmware Updates <FirmwareFile>505-uImage-ceiling-speaker</FirmwareFile>
                  <FirmwareServer>10.0.1.3</FirmwareServer>
                  <OutdoorIntercom30>firmware_file_v9.3.0</OutdoorIntercom30>
                  <OutdoorIntercom31>firmware_file_v10.3.0</OutdoorIntercom31>
                  <CallButton31>firmware_file_v10.3.0</CallButton31>
                  </FirmwareSettings>

```

In the <FirmwareSettings> section, the <FirmwareServer> element can be used to specify a different server for hosting firmware files. When this element is not available, the device will try to download the file from the autoprovisioning server.

The device will use the filename to determine when to autoprovision firmware updates. The default configuration is blank, so the first time you set a value in your autoprovisioning file, it may force a firmware update even if the firmware version has not changed.

The <FirmwareFile> name can contain path elements (i.e. /path/to/firmware/10.3.0-ulmage-[device_file_name]).

The device also supports product strings for downloading firmware. If the <FirmwareFile> option is not set, the device will look for its particular product string for a firmware filename. In this way, a generic autoprovisioning file can specify unique firmware for a range of products.

The list of valid product strings:

```

<ProductString>CallButton31</ProductString>
<ProductString>EmergencyIntercom31</ProductString>
<ProductString>EmergencyIntercom31SW</ProductString>
<ProductString>IndoorIntercom31</ProductString>
<ProductString>IndoorIntercom31SW</ProductString>
<ProductString>IndoorKeypad31</ProductString>
<ProductString>IndoorKeypad31SW</ProductString>
<ProductString>OfficeRinger31</ProductString>
<ProductString>OfficeRinger31SW</ProductString>
<ProductString>OutdoorIntercom31</ProductString>
<ProductString>OutdoorIntercom31SW</ProductString>
<ProductString>OutdoorKeypad31</ProductString>
<ProductString>OutdoorKeypad31SW</ProductString>
<ProductString>Strobe31</ProductString>
<ProductString>Strobe31SW</ProductString>

```

Autoprovisioning
Example 1

Here's a simple example using four autoprovisioning files to configure two devices:

We boot up two devices with mac addresses **00:20:f7:02:00:01** and **00:20:f7:02:00:02** (Device1 and Device2).

The devices are set to use DHCP and that server provides an autoprovisioning server address with option 43. The address is "https://autoprovtest.server.net." The files on this server are as follows:

000000cd.xml

```
<MiscSettings>
<DeviceName>CyberData Autoprovisioned</DeviceName>
<AutoprovFile>sip_common.xml</AutoprovFile>
<AutoprovFile>sip_[macaddress].xml</AutoprovFile>
</MiscSettings>
```

sip_common.xml

```
<SIPSettings>
<SIPServer>10.0.0.253</SIPServer>
<RemoteSIPPort>5060</RemoteSIPPort>
</SIPSettings>
```

sip_0020f7020001.xml

```
<SIPSettings>
<SIPUserID>198</SIPUserID>
<SIPAuthPassword>ext198</SIPAuthPassword>
<DialoutExtension0>204</DialoutExtension0>
</SIPSettings>
```

sip_0020f7020002.xml

```
<SIPSettings>
<SIPUserID>500</SIPUserID>
<SIPAuthPassword>ext500</SIPAuthPassword>
<DialoutExtension0>555</DialoutExtension0>
</SIPSettings>
```

On boot, Device1 tries to fetch the file **0020f7023614.xml** from "https://autoprovtest.server.net". This file is not available, so device1 then tries to fetch the file **000000cd.xml**. This file exists, and Device1 parses the three elements.

1. Device1 changes its device name to **CyberData Autoprovisioned**.
2. Device1 finds an AutoprovFile element containing the filename **sip_common.xml**. The device downloads **sip_common.xml** from "https://autoprovtest.server.net," and imports this configuration, setting the sip server to **10.0.0.253** and the remote port to **5060.3**.
3. Device1 finds another AutoprovFile element containing the filename **sip_[macaddress].xml**. The device replaces the **[macaddress]** with its own mac address value creating **sip_0020f7020001.xml**, downloads this file from "https://autoprovtest.server.net," and imports this configuration. This sets the user ID to **198**, the password to **ext198**, and the dialout extension to **204**. Device1 is now finished with autoprovisioning.

Device2 goes through the same steps by setting its device name to **CyberData Autoprovisioned**, its SIP server to **10.0.0.253**, and its port to **5060**. When Device2 “sees” **sip_[macaddress].xml**, Device2 replaces it with its own mac address and downloads **sip_0020f7020002.xml** from “https://autoprovtest.server.net.” Device2 sets the SIP User ID to **500**, the password to **ext500**, and the dialout extension to **555**.

Autoprovisioning Example 2

Here is another example of setting up your autoprovisioning files:

We boot up two devices with mac addresses **00:20:f7:02:00:01** and **00:20:f7:02:00:02** (Device1 and Device2) and boot them on a network with a DHCP server configured with an autoprovisioning server at **10.0.1.3** on option **150**. Our TFTP server has three files:

0020f7020001.xml

```
<MiscSettings>
<AutoprovFile>common_settings.xml</AutoprovFile>
</MiscSettings>
<SIPSettings>
<SIPUserID>198</SIPUserID>
<SIPAuthPassword>ext198</SIPAuthPassword>
<DialoutExtension0>204</DialoutExtension0>
</SIPSettings>
```

0020f7020002.xml

```
<MiscSettings>
<AutoprovFile>common_settings.xml</AutoprovFile>
</MiscSettings>
<SIPSettings>
<SIPUserID>500</SIPUserID>
<SIPAuthPassword>ext500</SIPAuthPassword>
<DialoutExtension0>555</DialoutExtension0>
</SIPSettings>
```

common_settings.xml

```
<MiscSettings>
<DeviceName>CyberData Autoprovisioned</DeviceName>
</MiscSettings>
<SIPSettings> <SIPServer>10.0.0.253</SIPServer>
<RemoteSIPPort>5060</RemoteSIPPort>
</SIPSettings>
```

1. On boot, Device1 downloads **0020f7020001.xml** from **10.0.1.3** and imports these values. The SIP User ID is **198**, the password is **ext198**, and the dialout extension is **204**.

2. Device1 then gets the filename **common_settings.xml** from the AutoprovFile element and downloads this file from the TFTP server at **10.0.1.3**. and imports these settings. The device name is set to **CyberData Autoprovisioned**, the SIP server is set to **10.0.0.253**, and the port is set to **5060**.

Device2 does the same except it downloads **0020f7020002.xml** on boot and imports these values instead. The Sip User ID is **500**, password is **ext500**, and dialout extension is **555**. Device2 then downloads the **common_settings.xml** file and imports those values. The device name is set to **CyberData Autoprovisioned**, the SIP server is set to **10.0.0.253**, and the port is set to **5060**.

XML Files

XML files can contain <AutoprovFile> elements. If multiple DHCP options are specified, the device will try to download auto provisioning files from each in turn. The device will only look for <AutoprovFile> elements in the first file downloaded from each server. You can specify up to 20 <AutoprovFile> elements in the first auto provisioning file.

There are numerous ways to change an element of the **configuration(xml)** file. Using **sip ext** as an example, the extension can be changed:

Within the device-specific xml, i.e. **[macaddress].xml**, via the AutoprovFile element:<SIPSettings>/<SIPExt>

From the device specific xml, a pointer to a sip_common file

From the device specific xml, a pointer to the device specific sip_[macaddress].xml

From the common file, a pointer to sip_common.xml

From the common file, a pointer to the device specific (sip_[macaddress].xml)

Autoprovisioned Audio Files

Audio files are stored in non-volatile memory and an auto provisioned audio file will only have to be downloaded once for each device. Loading many audio files to the device from the web page could cause it to appear unresponsive. If this happens, wait until the transfer is complete and then refresh the page.

The device uses the file name to determine when to download a new audio file. This means that if you used auto provisioning to upload a file and then changed the contents of this file at the TFTP server, the device will not recognize that the file has changed (because the file name is the same).

Since audio files are stored in non-volatile memory, if auto provisioning is disabled after they have been loaded to the board, the audio file settings will not change. You can force a change to the audio files on the board by clicking **Restore Default** on the **Audio** page or by changing the auto provisioning file with “**default**” set as the file name.

2.3.13.2 Sample dhcpd.conf

```
#
# Sample configuration file for ISC dhcpd for Debian
#

ddns-update-style none;

option domain-name "voiplab";
option domain-name-servers 10.0.0.252;
option option-150 code 150 = ip-address;
option ntp-servers north-america.pool.ntp.org;
option space VendorInfo;
option VendorInfo.text code 10 = { text };
authoritative;
log-facility local7;

subnet 10.0.0.0 netmask 255.0.0.0 {
    max-lease-time 3600;
    default-lease-time 3600;

    option routers                10.0.0.1;
    option subnet-mask            255.0.0.0;

    option domain-name            "voiplab";
    option domain-name-servers    10.0.0.252;

    option time-offset            -8;          # Pacific Standard Time

#   option www-server              99.99.99.99;      # OPTION 72

#   option tftp-server-name        "10.0.1.52";      # OPTION 66
#   option tftp-server-name        "http://test.cyberdata.net"; # OPTION 66

#   option option-150              10.0.0.252;      # OPTION 150

# These two lines are needed for option 43
#   vendor-option-space VendorInfo;                # OPTION 43
#   option VendorInfo.text "http://test.cyberdata.net"; # OPTION 43

    range 10.10.0.1 10.10.2.1; }
}
```

2.3.13.3 Download Template Button

The **Download Template** button allows the user to generate, download, edit, and then store an auto provisioning template on the server that serves the auto provisioning files for devices.

To generate an auto provisioning template directly from the device, complete the following steps:

1. On the **Auto provisioning** page, click on the **Download Template** button.
2. You will see a window prompting you to save a configuration file (**.xml**) to a location on your computer ([Figure 2-44](#)). The configuration file is the basis for the default configuration settings for your unit).
3. Choose a location to save the configuration file and click on **OK**. See [Figure 2-44](#).

Figure 2-44. Configuration File

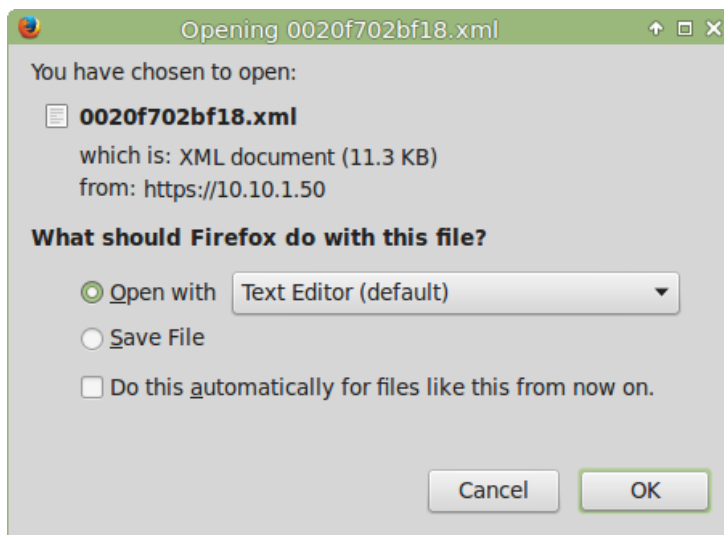

4. At this point, you can open and edit the auto provisioning template to change the configuration settings in the template for the unit.
5. You can then upload the auto provisioning file to a TFTP or HTTP server where the file can be loaded onto other devices.

2.4 Upgrade the Firmware and Reboot the SIP Loudspeaker Amplifier (PoE)

2.4.1 Downloading the Firmware

To download the firmware to your computer:

1. Download the latest firmware file from the **Downloads** tab at the following webpage:
<http://www.cyberdata.net/voip/011405/>
2. Unzip the firmware version file. This file may contain the following:
 - Firmware file
 - Release notes
3. Log in to the home page as instructed in [Section 2.3.4, "Using the Toggle Help Button"](#).
4. Click on the **Firmware** menu button to open the **Firmware** page. See [Figure 2-45](#).

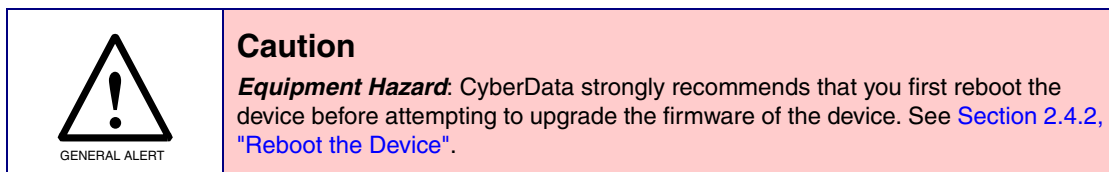
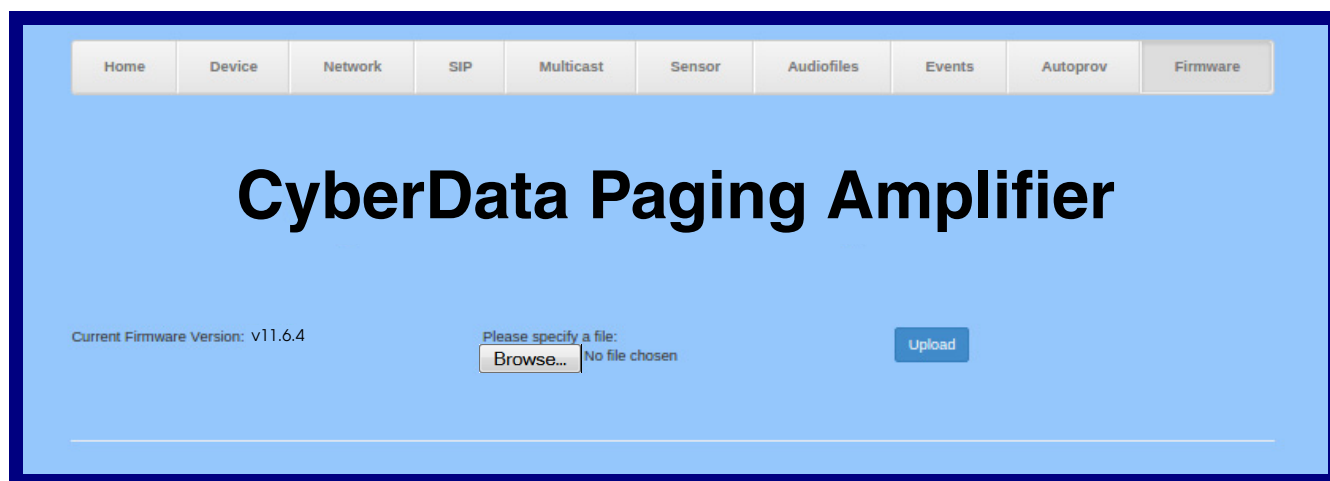

Figure 2-45. Firmware Page





5. Click on the **Browse** button, and then navigate to the location of the firmware file.
6. Select the firmware file.
7. Click on the **Upload** button.

Note Do not reboot the device after clicking on the **Upload** button.

Note This starts the upgrade process. Once the SIP Loudspeaker Amplifier (PoE) has uploaded the file, the **Uploading Firmware** countdown page appears, indicating that the firmware is being written to flash. The SIP Loudspeaker Amplifier (PoE) will automatically reboot when the upload is complete. When the countdown finishes, the **Firmware** page will refresh. The uploaded firmware filename should be displayed in the system configuration (indicating a successful upload and reboot).

8. [Table 2-26](#) shows the web page items on the **Firmware** page.

Table 2-26. Firmware Parameters

Web Page Item	Description
Current Firmware Version	Shows the current firmware version.
	Use the Browse button to navigate to the location of the firmware file that you want to upload.
	Click on the Upload button to automatically upload the selected firmware and reboot the system.

2.4.2 Reboot the Device

To reboot a SIP Loudspeaker Amplifier (PoE), log in to the web page as instructed in [Section 2.3.5, "Log in to the Home Page"](#).

1. Click on the **Reboot** button on the **Home** page ([Figure 2-46](#)). A normal restart will occur.

Figure 2-46. Home Page

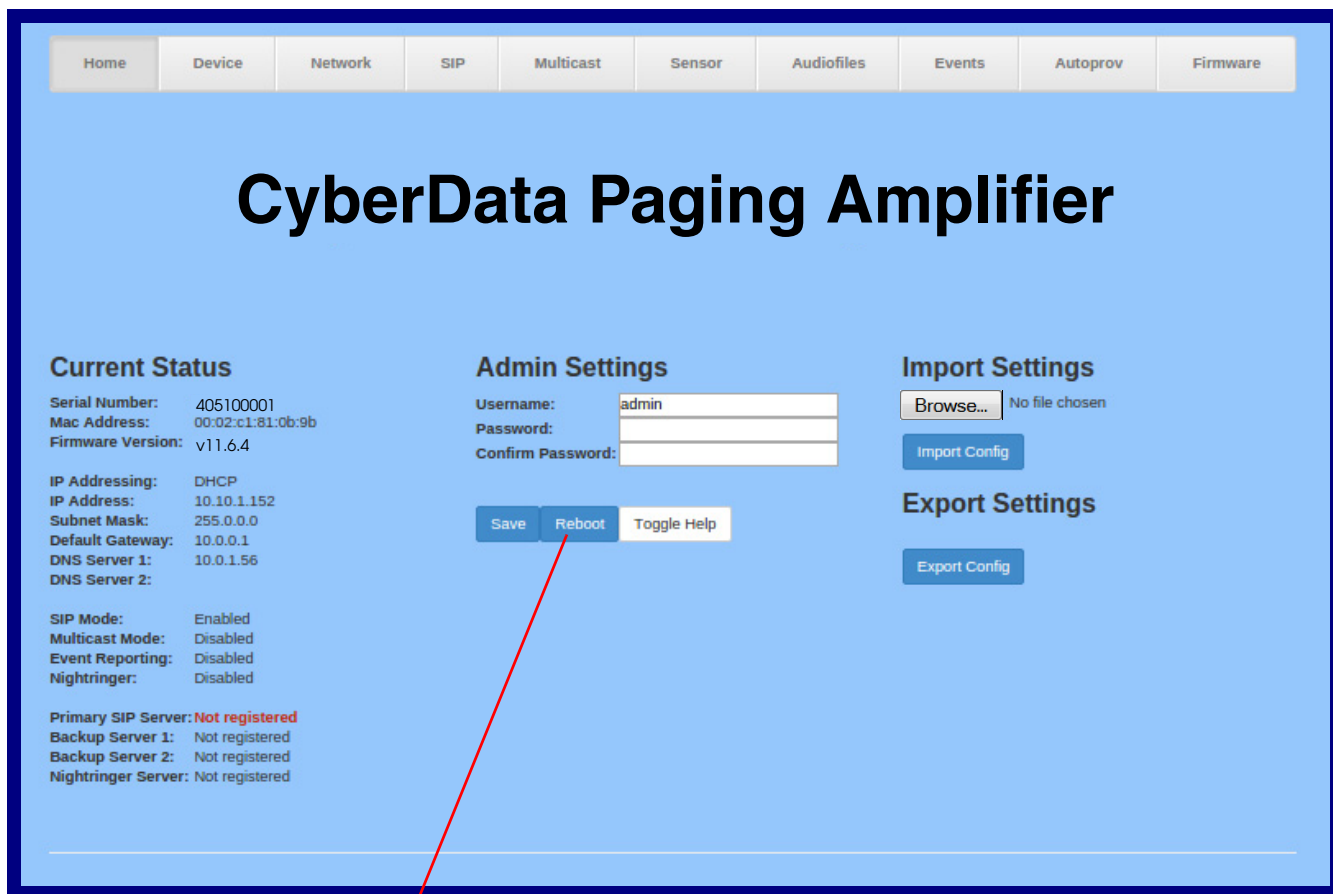

Reboot

2.5 Command Interface

Some functions on the device can be activated using simple POST commands to the web interface. The examples in [Table 2-27](#) use the free unix utility, **wget**, but any program that can send http POST commands to the device should work.

2.5.1 Command Interface Post Commands

Note These commands require an authenticated session (a valid username and password to work).

Table 2-27. Command Interface Post Commands

Device Action	HTTP Post Command ^a
Trigger relay (for configured delay)	wget --user admin --password admin --auth-no-challenge --no-check-certificate --quiet -O /dev/null "https://10.0.3.71/cgi-bin/command.cgi" --post-data "test_relay=yes"
Place call to extension (example: extension 130)	wget --user admin --password admin --auth-no-challenge --no-check-certificate --quiet -O /dev/null "https://10.0.3.71/cgi-bin/command.cgi" --post-data "call=130"
Terminate active call	wget --user admin --password admin --auth-no-challenge --no-check-certificate --quiet -O /dev/null "https://10.0.3.71/cgi-bin/command.cgi" --post-data "terminate=yes"
Force reboot	wget --user admin --password admin --auth-no-challenge --no-check-certificate --quiet -O /dev/null "https://10.0.3.71/cgi-bin/command.cgi" --post-data "reboot=yes"
Test Audio button	wget --user admin --password admin --auth-no-challenge --no-check-certificate --quiet -O /dev/null "https://10.0.3.71/cgi-bin/command.cgi" --post-data "test_audio=yes"
Announce IP address	wget --user admin --password admin --auth-no-challenge --no-check-certificate --quiet -O /dev/null "https://10.0.3.71/cgi-bin/command.cgi" --post-data "speak_ip_address=yes"
Play the "0" audio file	wget --user admin --password admin --auth-no-challenge --no-check-certificate --quiet -O /dev/null "https://10.0.3.71/cgi-bin/audiofiles.cgi" --post-data "play_0=yes"
Play the "1" audio file	wget --user admin --password admin --auth-no-challenge --no-check-certificate --quiet -O /dev/null "https://10.0.3.71/cgi-bin/audiofiles.cgi" --post-data "play_1=yes"
Play the "2" audio file	wget --user admin --password admin --auth-no-challenge --no-check-certificate --quiet -O /dev/null "https://10.0.3.71/cgi-bin/audiofiles.cgi" --post-data "play_2=yes"
Play the "3" audio file	wget --user admin --password admin --auth-no-challenge --no-check-certificate --quiet -O /dev/null "https://10.0.3.71/cgi-bin/audiofiles.cgi" --post-data "play_3=yes"
Play the "4" audio file	wget --user admin --password admin --auth-no-challenge --no-check-certificate --quiet -O /dev/null "https://10.0.3.71/cgi-bin/audiofiles.cgi" --post-data "play_4=yes"

Table 2-27. Command Interface Post Commands (continued)

Device Action	HTTP Post Command^a
Play the "5" audio file	wget --user admin --password admin --auth-no-challenge --no-check-certificate --quiet -O /dev/null "https://10.0.3.71/cgi-bin/audiofiles.cgi" --post-data "play_5=yes"
Play the "6" audio file	wget --user admin --password admin --auth-no-challenge --no-check-certificate --quiet -O /dev/null "https://10.0.3.71/cgi-bin/audiofiles.cgi" --post-data "play_6=yes"
Play the "7" audio file	wget --user admin --password admin --auth-no-challenge --no-check-certificate --quiet -O /dev/null "https://10.0.3.71/cgi-bin/audiofiles.cgi" --post-data "play_7=yes"
Play the "8" audio file	wget --user admin --password admin --auth-no-challenge --no-check-certificate --quiet -O /dev/null "https://10.0.3.71/cgi-bin/audiofiles.cgi" --post-data "play_8=yes"
Play the "9" audio file	wget --user admin --password admin --auth-no-challenge --no-check-certificate --quiet -O /dev/null "https://10.0.3.71/cgi-bin/audiofiles.cgi" --post-data "play_9=yes"
Play the "Dot" audio file	wget --user admin --password admin --auth-no-challenge --no-check-certificate --quiet -O /dev/null "https://10.0.3.71/cgi-bin/audiofiles.cgi" --post-data "play_d=yes"
Play the "Audio Test" audio file (from Audio Config)	wget --user admin --password admin --auth-no-challenge --no-check-certificate --quiet -O /dev/null "https://10.0.3.71/cgi-bin/audiofiles.cgi" --post-data "play_audiotest=yes"
Play the "Page Tone" audio file	wget --user admin --password admin --auth-no-challenge --no-check-certificate --quiet -O /dev/null "https://10.0.3.71/cgi-bin/audiofiles.cgi" --post-data "play_pagetone=yes"
Play the "Your IP Address Is" audio file	wget --user admin --password admin --auth-no-challenge --no-check-certificate --quiet -O /dev/null "https://10.0.3.71/cgi-bin/audiofiles.cgi" --post-data "play_youripaddressis=yes"
Play the "Rebooting" audio file	wget --user admin --password admin --auth-no-challenge --no-check-certificate --quiet -O /dev/null "https://10.0.3.71/cgi-bin/audiofiles.cgi" --post-data "play_rebooting=yes"
Play the "Restoring Default" audio file	wget --user admin --password admin --auth-no-challenge --no-check-certificate --quiet -O /dev/null "https://10.0.3.71/cgi-bin/audiofiles.cgi" --post-data "play_restoringdefault=yes"
Play the "Ringback tone" audio file	wget --user admin --password admin --auth-no-challenge --no-check-certificate --quiet -O /dev/null "https://10.0.3.71/cgi-bin/audiofiles.cgi" --post-data "play_ringback=yes"
Play the "Ring tone" audio file	wget --user admin --password admin --auth-no-challenge --no-check-certificate --quiet -O /dev/null "https://10.0.3.71/cgi-bin/audiofiles.cgi" --post-data "play_ringtones=yes"
Play the "Night Ring" audio file	wget --user admin --password admin --auth-no-challenge --no-check-certificate --quiet -O /dev/null "https://10.0.3.71/cgi-bin/audiofiles.cgi" --post-data "play_nightring=yes"
Delete the "0" audio file	wget --user admin --password admin --auth-no-challenge --no-check-certificate --quiet -O /dev/null "https://10.0.3.71/cgi-bin/audiofiles.cgi" --post-data "delete_0=yes"
Delete the "1" audio file	wget --user admin --password admin --auth-no-challenge --no-check-certificate --quiet -O /dev/null "https://10.0.3.71/cgi-bin/audiofiles.cgi" --post-data "delete_1=yes"

Table 2-27. Command Interface Post Commands (continued)

Device Action	HTTP Post Command^a
Delete the "2" audio file	<code>wget --user admin --password admin --auth-no-challenge --no-check-certificate --quiet -O /dev/null "https://10.0.3.71/cgi-bin/audiofiles.cgi" --post-data "delete_2=yes"</code>
Delete the "3" audio file	<code>wget --user admin --password admin --auth-no-challenge --no-check-certificate --quiet -O /dev/null "https://10.0.3.71/cgi-bin/audiofiles.cgi" --post-data "delete_3=yes"</code>
Delete the "4" audio file	<code>wget --user admin --password admin --auth-no-challenge --no-check-certificate --quiet -O /dev/null "https://10.0.3.71/cgi-bin/audiofiles.cgi" --post-data "delete_4=yes"</code>
Delete the "5" audio file	<code>wget --user admin --password admin --auth-no-challenge --no-check-certificate --quiet -O /dev/null "https://10.0.3.71/cgi-bin/audiofiles.cgi" --post-data "delete_5=yes"</code>
Delete the "6" audio file	<code>wget --user admin --password admin --auth-no-challenge --no-check-certificate --quiet -O /dev/null "https://10.0.3.71/cgi-bin/audiofiles.cgi" --post-data "delete_6=yes"</code>
Delete the "7" audio file	<code>wget --user admin --password admin --auth-no-challenge --no-check-certificate --quiet -O /dev/null "https://10.0.3.71/cgi-bin/audiofiles.cgi" --post-data "delete_7=yes"</code>
Delete the "8" audio file	<code>wget --user admin --password admin --auth-no-challenge --no-check-certificate --quiet -O /dev/null "https://10.0.3.71/cgi-bin/audiofiles.cgi" --post-data "delete_8=yes"</code>
Delete the "9" audio file	<code>wget --user admin --password admin --auth-no-challenge --no-check-certificate --quiet -O /dev/null "https://10.0.3.71/cgi-bin/audiofiles.cgi" --post-data "delete_9=yes"</code>
Delete the "Audio Test" audio file	<code>wget --user admin --password admin --auth-no-challenge --no-check-certificate --quiet -O /dev/null "https://10.0.3.71/cgi-bin/audiofiles.cgi" --post-data "delete_audiotest=yes"</code>
Delete the "Page Tone" audio file	<code>wget --user admin --password admin --auth-no-challenge --no-check-certificate --quiet -O /dev/null "https://10.0.3.71/cgi-bin/audiofiles.cgi" --post-data "delete_pagetone=yes"</code>
Delete the "Your IP Address Is" audio file	<code>wget --user admin --password admin --auth-no-challenge --no-check-certificate --quiet -O /dev/null "https://10.0.3.71/cgi-bin/audiofiles.cgi" --post-data "delete_youripaddressis=yes"</code>
Delete the "Rebooting" audio file	<code>wget --user admin --password admin --auth-no-challenge --no-check-certificate --quiet -O /dev/null "https://10.0.3.71/cgi-bin/audiofiles.cgi" --post-data "delete_rebooting=yes"</code>
Delete the "Restoring Default" audio file	<code>wget --user admin --password admin --auth-no-challenge --no-check-certificate --quiet -O /dev/null "https://10.0.3.71/cgi-bin/audiofiles.cgi" --post-data "delete_restoringdefault=yes"</code>
Delete the "Ringback tone" audio file	<code>wget --user admin --password admin --auth-no-challenge --no-check-certificate --quiet -O /dev/null "https://10.0.3.71/cgi-bin/audiofiles.cgi" --post-data "delete_ringback=yes"</code>
Delete the "Ring tone" audio file	<code>wget --user admin --password admin --auth-no-challenge --no-check-certificate --quiet -O /dev/null "https://10.0.3.71/cgi-bin/audiofiles.cgi" --post-data "delete_ringtone=yes"</code>
Delete the "Night Ring" audio file	<code>wget --user admin --password admin --auth-no-challenge --no-check-certificate --quiet -O /dev/null "https://10.0.3.71/cgi-bin/audiofiles.cgi" --post-data "delete_nightring=yes"</code>

Table 2-27. Command Interface Post Commands (continued)

Device Action	HTTP Post Command^a
Trigger the Door Sensor Test (Sensor Config page)	wget --user admin --password admin --auth-no-challenge --no-check-certificate --quiet -O /dev/null "https://10.0.3.71/cgi-bin/sensor.cgi" --post-data "doortest=yes"

a. Type and enter all of each http POST command on one line.

Appendix A: Mounting the Amplifier

A.1 Mount the Amplifier

Before you mount the enclosure, make sure that you have received all of the parts for each enclosure. Refer to [Table A-1](#).

Table A-1. Wall Mounting Components (Part of the Accessory Kit)

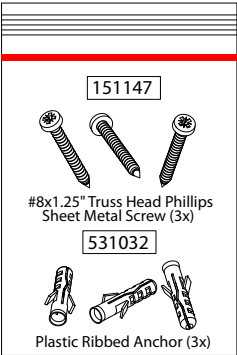
Quantity	Part Name	Illustration
1	Mounting Accessory Kit which includes: (3) #8 Plastic Anchors (3) #8 x 1-1/4" Pan Head Phillips Self-Tapping Screws	 <p>151147</p> <p>#8x1.25" Truss Head Phillips Sheet Metal Screw (3x)</p> <p>531032</p> <p>Plastic Ribbed Anchor (3x)</p>

Note The SIP Loudspeaker Amplifier (PoE) was designed for indoor use. Mounting it on the external part of a building will require additional hardware for weatherproofing, cabling access, and lightning suppression. Consult a certified electrician for details.

Note For mounting, use the three **#8 SHEET METAL SCREWS** to secure the enclosure.

A.1.1 Mounting the Enclosure

To mount the enclosure:

1. Prepare holes for the screws.
2. Plug in the power adapter and use the **Power (PWR)** LED to verify that the power is on.
3. Plug the ethernet cable into the device. The **Link/Activity (Link/Act.)** LED verifies the network connection.
4. For wall mounting, use the three #8 x 1-1/4-inch Truss Head Phillip screws to secure the speaker. See [Figure A-1](#).

Figure A-1. Mounting the Enclosure

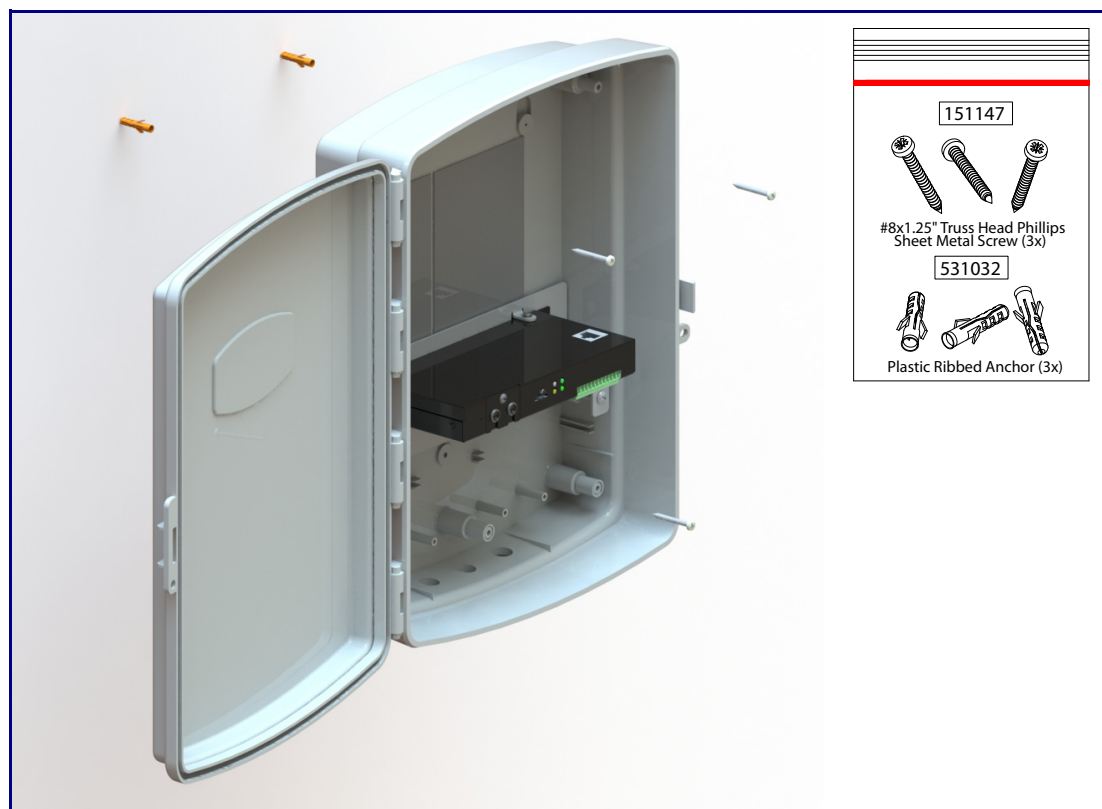

Appendix B: Setting up a TFTP Server

B.1 Set up a TFTP Server

Autoprovisioning requires a TFTP server for hosting the configuration file.

B.1.1 In a LINUX Environment

To set up a TFTP server on LINUX:

1. Create a directory dedicated to the TFTP server, and move the files to be uploaded to that directory.
2. Run the following command where `/tftpboot/` is the path to the directory you created in [Step 1](#): the directory that contains the files to be uploaded. For example:

```
in.tftpd -l -s /tftpboot/your_directory_name
```

B.1.2 In a Windows Environment

You can find several options online for setting up a Windows TFTP server. This example explains how to use the Solarwinds freeware TFTP server, which you can download at:

<http://www.cyberdata.net/support/voip/solarwinds.html>

To set up a TFTP server on Windows:

1. Install and start the software.
2. Select **File/Configure/Security** tab/**Transmit Only**.
3. Make a note of the default directory name, and then move the firmware files to be uploaded to that directory.

Appendix C: Troubleshooting/Technical Support

C.1 Frequently Asked Questions (FAQ)

To see a list of frequently asked questions for your product, click on the **FAQs** tab at the following webpage:

<http://www.cyberdata.net/voip/011405/>

C.2 Documentation

The documentation for this product is released in an English language version only.

To download PDF copies of CyberData product documentation, click on the **Downloads** tab at the following webpage:

<http://www.cyberdata.net/voip/011405/>

C.3 Contact Information

Contact CyberData Corporation
 3 Justin Court
 Monterey, CA 93940 USA
 www.CyberData.net
 Phone: 800-CYBERDATA (800-292-3732)
 Fax: 831-373-4193

Sales Sales 831-373-2601, Extension 334

Technical The fastest way to get technical support for your VoIP product is to submit a VoIP Technical
Support Support form at the following website:

<http://support.cyberdata.net/>

The Support Form initiates a ticket which CyberData uses for tracking customer requests. Most importantly, the Support Form tells us which PBX system and software version that you are using, the make and model of the switch, and other important information. This information is essential for troubleshooting. Please also include as much detail as possible in the **Comments** section of the Support Form.

Phone: (831) 373-2601, Extension 333

C.4 Warranty and RMA Information

The most recent warranty and RMA information is available at the following website address:

<http://support.cyberdata.net/>

Index

Symbols

#6 sheet metal screws 96

Numerics

1 speaker configuration 12, 13, 14
 16 gauge wire 12, 13, 14
 2 speaker configuration 14
 802.3af mode 12, 13, 14
 802.3at compliance switch 12, 13, 14
 802.3at mode 14
 802.3at power injector (high power mode) 12, 13, 14

A

accessory kit 8, 96
 activate relay (door sensor) 62
 activity LED 22
 address, configuration login 33
 amplified outputs 12, 13, 14
 high power mode 14
 how to use and connect 12
 low power mode 12, 13
 announcing an IP address 23
 audio configuration 64
 night ring tone parameter 68
 audio encodings 4
 audio files, user-created 69
 audio page 64
 audio test 23
 autoprovision at time (HHMMSS) 78
 autoprovision when idle (in minutes > 10) 78
 autoprovisioning 79
 download template button 79
 autoprovisioning autoupdate (in minutes) 78
 autoprovisioning configuration 77, 78
 autoprovisioning filename 78
 autoprovisioning server (IP Address) 78

B

backup SIP server 1 48
 backup SIP server 2 48
 backup SIP servers, SIP server
 backups 48

boost (volume) 38

C

cabling 21
 changing
 the web access password 37
 Cisco SRST 48
 command interface 92
 commands 92
 components 11
 configurable parameters 48
 configuration
 audio 64
 default IP settings 27
 door sensor 60
 intrusion sensor 60
 network 44
 SIP 47
 configuration home page 33
 connecting the amplified outputs 12
 connection options 15
 connections 11, 15
 connections inside of the NEMA box 11
 contact information 100
 contact information for CyberData 100
 current network settings 45
 CyberData contact information 100

D

default
 gateway 9, 27
 IP address 9, 27
 subnet mask 9, 27
 username and password 9, 27
 web login username and password 33
 default gateway 9, 27, 45
 default IP settings 27
 default login address 33
 device configuration 37
 device configuration page 37
 device configuration parameters 38
 device configuration password
 changing for web configuration access 37
 DHCP Client 4
 dial out extension (door sensor) 62
 dial out extension strings 53

dial-out extension strings 55
 dimensions 5
 disable volume control dial 38
 discovery utility program 33
 distortion, total harmonic 5
 DNS server 45
 door sensor 60, 68
 activate relay 62
 dial out extension 62
 door sensor normally closed 62
 play audio locally 62
 download autoprovisioning template button 79
 DTMF tones 53, 55
 DTMF tones (using rfc2833) 53

E

enable night ring events 72
 enclosure, mounting 96
 ethernet I/F 5
 event configuration
 enable night ring events 72
 expiration time for SIP server lease 49, 51
 export settings 35

F

factory defaults 10, 23
 firmware
 where to get the latest firmware 89

G

get autoprovisioning template 79
 GMT table 42
 GMT time 42

H

harmonic distortion 5
 hazard levels 4
 high power mode (amplified outputs) 14
 home page 33
 http POST command 92
 http web-based configuration 4

I

identifier names (PST, EDT, IST, MUT) 42
 identifying your product 1
 illustration of amplifier mounting process 96
 import settings 35
 import/export settings 35
 input specifications 5
 installation 2
 IP address 9, 27, 45
 IP address announcement 23
 IP address confirmation 23
 IP addressing
 default
 IP addressing setting 9, 27

J

jumper descriptions 20
 jumper locations 20

L

lease, SIP server expiration time 49, 51
 LEDs 22
 lengthy pages 59
 line input specifications 5
 line output specifications 5
 Linux, setting up a TFTP server on 98
 local SIP port 49
 log in address 33
 loudspeaker type 21
 loudspeaker, cabling/wiring 21
 low power mode (amplified outputs) 12, 13

M

maximum wire length for two speaker configuration 14
 MGROUP
 MGROUP Name 58
 mounting an amplifier 96
 multicast configuration 56, 64
 Multicast IP Address 58

N

navigation (web page) 28
 navigation table 28

NEMA box components 11
 network configuration 44
 network link activity, verifying 22
 nightring tones 59
 Nightringer 88
 nightringer settings 50
 NTP server 38

O

one speaker configuration 12, 13, 14
 optional two speaker configuration 14
 output impedance 5
 output level 5
 output signal amplitudes 5
 output specifications 5

P

packet time 4
 pages (lengthy) 59
 parts list 8
 password
 for SIP server login 48
 login 33
 restoring the default 9, 27
 payload types 5
 play audio locally (door sensor) 62
 point-to-point configuration 54
 polycom default channel 59
 polycom emergency channel 59
 polycom priority channel 59
 port
 local SIP 49
 remote SIP 49
 posix timezone string
 timezone string 38
 POST command 92
 power input 5
 power LED 10, 22
 power, connecting to paging amplifier 12
 priority
 assigning 59
 product
 mounting 96
 parts list 8
 product features 3
 product overview
 product features 3
 product specifications 5
 supported protocols 4
 supported SIP servers 4

typical system installation 2
 product specifications 5
 protocols supported 4

R

reboot 90, 91
 remote SIP port 49
 reset test function management switch 23
 resetting the IP address to the default 96
 restoring the factory defaults 10, 23
 ringtones 59
 lengthy pages 59
 rport discovery setting, disabling 49
 RTFM switch 10, 23
 RTP/AVP 4

S

safety instructions 5
 sales 100
 sensor
 sensor normally closed 62
 sensor timeout 62
 sensor connection 16
 sensor setup page 61
 sensor setup parameters 60
 sensors 62
 server address, SIP 48
 service 100
 set time with external NTP server on boot 38
 SIP
 enable SIP operation 48
 local SIP port 49
 user ID 48
 SIP (session initiation protocol) 4
 SIP configuration 47
 SIP configuration parameters
 outbound proxy 49, 51
 registration and expiration, SIP server lease 49, 51
 unregister on reboot 49
 user ID, SIP 48
 SIP registration 48
 SIP remote SIP port 49
 SIP server 48
 password for login 48
 SIP servers supported 4
 unregister from 49
 user ID for login 48
 SIP server configuration 48
 SIP volume 38
 speaker cable 21

- speaker configuration 12, 13, 14
- speaker configuration for two speakers 14
- speaker wire 21
- SRST 48
- standard 1 speaker configuration 12, 13, 14
- status LED 10, 22
- subnet mask 9, 27, 45
- supported protocols 4

T

- tech support 100
- technical support, contact information 100
- test audio 23
- TFTP server 4, 98
- time zone string examples 42
- two speaker configuration 14

U

- user ID
 - for SIP server login 48
- username
 - changing for web configuration access 37
 - default for web configuration access 33
 - restoring the default 9, 27
- using the amplified outputs 12

V

- verifying
 - network link and activity 22
 - power on 22
- VLAN ID 45
- VLAN Priority 45
- VLAN tagging support 45
- VLAN tags 45
- volume 26
 - multicast volume 38
 - ring volume 38
 - sensor volume 38
 - SIP volume 38
- volume adjustment 24
- volume boost 38
- volume control dial
 - disable 38
- volume dial 25, 26

W

- warranty policy at CyberData 100
- web access password 9, 27
- web access username 9, 27
- web configuration log in address 33
- web page
 - navigation 28
- web page navigation 28
- wget, free unix utility 92
- Windows, setting up a TFTP server on 98
- wire gauge 12, 13, 14
- wire length going to wire nuts for two speaker configuration 14
- wire nuts to connect wire 12, 13, 14
- wiring 21