

1.0 Out-of-Box and Prior to Final Installation

- 3.1. Verify that you have received all of the parts listed on the *Installation Quick Reference* placemat.
- 3.2. Download the current manual, otherwise known as an *Operation Guide*, which is available in the **Downloads** tab at the following webpage:
<https://www.cyberdata.net/products/011406/>

Note You can also navigate to the **Downloads** tab by going to www.CyberData.net and following the steps that are indicated by the following figures:



1 **A OUR PRODUCTS**



B VOIP PRODUCTS



2



SINGLEWIRE

3 011406 SINGLEWIRE INFORMACAST
LOUDSPEAKER AMPLIFIER-AC-POWERED



4 Downloads



2.0 Select Power Source

IEEE 802.3af or 802.3at PoE Switch	IEEE 802.3af or 802.3at PoE Injector
Set PoE power type to Class 0 = 15.4W OR for high power PoE+ set Class 4 = 30W	CAT6 cable recommended— for longer distances
Be sure you are using a non-PoE switch or port	
Make sure port is not in trunk mode	
Set port to full duplex/ 100mbps	
Spanning Tree Protocol (STP) must be disabled or Portfast enabled	

3.0 Power Test

- 3.1. Plug in the CyberData device and monitor the LED activity on the front of the device during the initialization process. See the following figure:

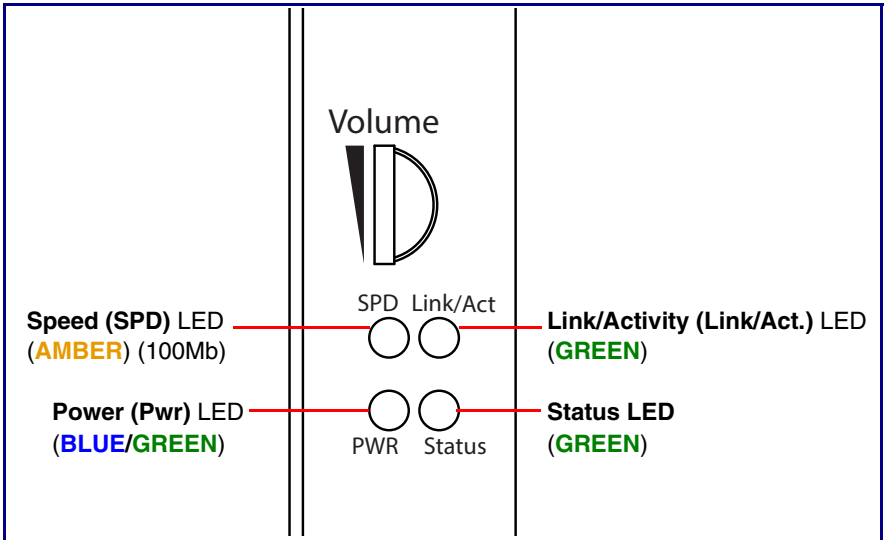

- 3.2. The **Power (Pwr)** LED is **GREEN** for 802.3af and is **BLUE** for 802.3at. The **GREEN Status** LED and the **GREEN Power (Pwr)** LED come on immediately. The **Speed (SPD)** LED illuminates **AMBER** for a 100Mb link or is off for 10MB when the network link to the device is established. The **Link/Activity** LED blinks to indicate network traffic.

After about 20 seconds, the **GREEN Status** LED will blink fast to indicate that the device is acquiring an IP address and attempting to autoprovision. It will turn off thereafter until the device has finished booting. When the device has fully booted, the **GREEN Status** LED will turn on solid.

If there is no DHCP server available on the network, it will try 12 times for 60 seconds and eventually fall back to the programmed static IP address (by default 10.10.10.10) or the previously used DHCP address if a prior lease was established. This process will take approximately 80 seconds.

- 3.3. When the device has completed the initialization process, press and hold the RTFM switch for 3 seconds to announce the IP address.

This concludes the power test. Go to [Section 4.0, "InformaCast Configuration File Retrieval"](#).

4.0 InformaCast Configuration File Retrieval

4.1. **DHCP should be enabled.** After the device initializes, it will send a broadcast to the DHCP server to ask for the location of its InformaCastSpeaker.cfg configuration file.

4.2. SLP or TFTP?

- **SLP** should be enabled on InformaCast version 5.0.4 or higher. SLP is an InformaCast protocol introduced in InformaCast version 5.0.4. The device will retrieve its configuration file from an InformaCast server folder specified by SLP. SLP method is preferred.
- **TFTP** servers may be used instead of SLP. In this alternate scenario, DHCP option 150 is required to provide the device with the address of the TFTP server. Otherwise, the device will be unable to retrieve its configuration file.

Note The device and InformaCast server should be on the same subnet during the device's initial configuration if it cannot access the VLANs upon which the InformaCast Server and DHCP servers are located.

5.0 Identification and Testing

5.1. Ensure the InformaCast Server has detected a new device.

5.2. Test the newly detected device.

5.3. Add the newly detected device to the InformaCast Server.

6.0 Contacting CyberData VoIP Technical Support

You are welcome to call CyberData VoIP Technical Support at 831-373-2601 x333. Business hours are 7:00 AM - 5:00 PM Pacific Time, Monday through Friday.

We encourage you to access our Technical Support help desk at the following address:

<http://support.cyberdata.net/>

Note You can also access the Technical Support help desk by going to www.CyberData.net and clicking on the **SUPPORT** menu.

The Technical Support help desk provides the options of accessing documentation for your CyberData product, browsing the knowledge base, and submitting a troubleshooting ticket.

Please be advised requests for Returned Materials Authorization (RMA) numbers require an active VoIP Technical Support ticket number. A product will not be accepted for return without an approved RMA number.