



InformaCast Enabled Wall Mount Speaker Operations Guide

Part #011505

Document Part #931687A
for Firmware Version 1.0.0

CyberData Corporation
3 Justin Court
Monterey, CA 93940
(831) 373-2601

SIP Speaker Operations Guide 931687A
Part # 011505

COPYRIGHT NOTICE:

© 2019, CyberData Corporation, ALL RIGHTS RESERVED.

This manual and related materials are the copyrighted property of CyberData Corporation. No part of this manual or related materials may be reproduced or transmitted, in any form or by any means (except for internal use by licensed customers), without prior express written permission of CyberData Corporation. This manual, and the products, software, firmware, and/or hardware described in this manual are the property of CyberData Corporation, provided under the terms of an agreement between CyberData Corporation and recipient of this manual, and their use is subject to that agreement and its terms.

DISCLAIMER: Except as expressly and specifically stated in a written agreement executed by CyberData Corporation, CyberData Corporation makes no representation or warranty, express or implied, including any warranty or merchantability or fitness for any purpose, with respect to this manual or the products, software, firmware, and/or hardware described herein, and CyberData Corporation assumes no liability for damages or claims resulting from any use of this manual or such products, software, firmware, and/or hardware. CyberData Corporation reserves the right to make changes, without notice, to this manual and to any such product, software, firmware, and/or hardware.

OPEN SOURCE STATEMENT: Certain software components included in CyberData products are subject to the GNU General Public License (GPL) and Lesser GNU General Public License (LGPL) “open source” or “free software” licenses. Some of this Open Source Software may be owned by third parties. Open Source Software is not subject to the terms and conditions of the CyberData COPYRIGHT NOTICE or software licenses. Your right to copy, modify, and distribute any Open Source Software is determined by the terms of the GPL, LGPL, or third party, according to who licenses that software.

Software or firmware developed by CyberData that is unrelated to Open Source Software is copyrighted by CyberData, subject to the terms of CyberData licenses, and may not be copied, modified, reverse-engineered, or otherwise altered without explicit written permission from CyberData Corporation.

TRADEMARK NOTICE: CyberData Corporation and the CyberData Corporation logos are trademarks of CyberData Corporation. Other product names, trademarks, and service marks may be the trademarks or registered trademarks of their respective owners.



Technical Support

The fastest way to get technical support for your VoIP product is to submit a VoIP Technical Support form at the following website:

<http://support.cyberdata.net/>

Phone: (831) 373-2601, Ext. 333

Email: support@cyberdata.net

Fax: (831) 373-4193

Company and product information is at www.cyberdata.net.

Revision Information



Revision 931687A, which corresponds to firmware version 1.0.0, was released on July 15, 2019.

Browsers Supported

The following browsers have been tested against firmware version 1.0.0:

- Internet Explorer (version: 11)
- Firefox (also called Mozilla Firefox) (version: 62.0)
- Chrome (version: 63.0.3239.132)
- Safari (version: 12)
- Microsoft Edge (version: 42.17134.1.0)

Pictorial Alert Icons

	<p>General Alert</p> <p><i>This pictorial alert indicates a potentially hazardous situation. This alert will be followed by a hazard level heading and more specific information about the hazard.</i></p>
	<p>Ground</p> <p><i>This pictorial alert indicates the Earth grounding connection point.</i></p>

Hazard Levels

Danger: Indicates an imminently hazardous situation which, if not avoided, will result in death or serious injury. This is limited to the most extreme situations.

Warning: Indicates a potentially hazardous situation which, if not avoided, could result in death or serious injury.

Caution: Indicates a potentially hazardous situation which, if not avoided, could result in minor or moderate injury. It may also alert users against unsafe practices.



Notice: Indicates a statement of company policy (that is, a safety policy or protection of property).

The safety guidelines for the equipment in this manual do not purport to address all the safety issues of the equipment. It is the responsibility of the user to establish appropriate safety, ergonomic, and health practices and determine the applicability of regulatory limitations prior to use. Potential safety hazards are identified in this manual through the use of words Danger, Warning, and Caution, the specific hazard type, and pictorial alert icons.

Important Safety Instructions

1. Read these instructions.
2. Keep these instructions.
3. Heed all warnings.
4. Follow all instructions.
5. Do not use this apparatus near water.
6. Clean only with dry cloth.
7. Do not block any ventilation openings. Install in accordance with the manufacturer's instructions.
8. Do not install near any heat sources such as radiators, heat registers, stoves, or other apparatus (including amplifiers) that produce heat.
9. Do not defeat the safety purpose of the polarized or grounding-type plug. A polarized plug has two blades with one wider than the other. A grounding type plug has two blades and a third grounding prong. The wide blade or the third prong are provided for your safety. If the provided plug does not fit into your outlet, consult an electrician for replacement of the obsolete outlet.
10. Protect the power cord from being walked on or pinched particularly at plugs, convenience receptacles, and the point where they exit from the apparatus.
11. Only use attachments/accessories specified by the manufacturer.
12. Refer all servicing to qualified service personnel. Servicing is required when the apparatus has been damaged in any way, such as power-supply cord or plug is damaged, liquid has been spilled or objects have fallen into the apparatus, the apparatus has been exposed to rain or moisture, does not operate normally, or has been dropped.
13. Prior to installation, consult local building and electrical code requirements.

14. WARNING: The InformaCast Enabled Ceiling Speaker enclosure is not rated for any AC voltages!

 <p>GENERAL ALERT</p>	<p>Warning</p> <p><i>Electrical Hazard:</i> This product should be installed by a licensed electrician according to all local electrical and building codes.</p>
 <p>GENERAL ALERT</p>	<p>Warning</p> <p><i>Electrical Hazard:</i> To prevent injury, this apparatus must be securely attached to the floor/wall in accordance with the installation instructions.</p>
 <p>GENERAL ALERT</p>	<p>Warning</p> <p>The PoE connector is intended for intra-building connections only and does not route to the outside plant.</p>

Abbreviations and Terms

Abbreviation or Term	Definition
A-law	A standard companding algorithm, used in European digital communications systems to optimize, i.e., modify, the dynamic range of an analog signal for digitizing.
AVP	Audio Video Profile
Cat 5	TIA/EIA-568-B Category 5
DHCP	Dynamic Host Configuration Protocol
LAN	Local Area Network
LED	Light Emitting Diode
Mbps	Megabits per Second.
NTP	Network Time Protocol
PBX	Private Branch Exchange
PoE	Power over Ethernet (as per IEEE 802.3af standard)
RTFM	Reset Test Function Management
SIP	Session Initiated Protocol
u-law	A companding algorithm, primarily used in the digital telecommunication
UC	Unified Communications
VoIP	Voice over Internet Protocol

Contents

Chapter 1 Product Overview	1
1.1 How to Identify This Product	1
1.2 Typical Configuration	2
1.3 Product Features	3
1.4 Supported Protocols	4
1.5 Product Specifications	5
1.6 Compliance	6
1.6.1 CE Testing	6
1.6.2 FCC Statement	6
Chapter 2 Installing the Multicast Ceiling Speaker	7
2.1 Parts List	7
2.2 Device Configuration	8
2.2.1 Connect Power to the Speaker	9
2.2.2 Confirm that the Speaker is Operational and Linked to the Network	11
2.2.3 Confirm the IP Address and Test the Audio	12
2.2.4 How to Set the Factory Default Settings	13
2.3.1 Factory Default Settings	14
2.3.2 Multicast Ceiling Speaker Web Page Navigation	15
2.3.3 Using the Toggle Help Button	16
2.3.4 Log in to the Configuration Home Page	18
2.3.5 Configure the Device	22
2.3.6 Configure the Network Parameters	25
2.3.7 Configure the SSL Parameters	28
2.3.8 Configure the Multicast Parameters	33
2.3.9 Configure the Audio Configuration Parameters	35
2.3.10 Configure the Events Parameters	39
2.3.11 Configure the Autoprovisioning Parameters	44
2.4.1 Downloading the Firmware	55
2.4.2 Reboot the Device	58
2.5.1 Command Interface Post Commands	59
Appendix A Mounting the Speaker	61
A.1 Mounting	61
A.2 Dimensions	62
Appendix C Setting up a TFTP Server	63
C.1 Set up a TFTP Server	63
C.1.1 Autoprovisioning requires a TFTP server for hosting the configuration file.	63
C.1.2 In a LINUX Environment	63
C.1.3 In a Windows Environment	63
Appendix C Troubleshooting/Technical Support	64
C.1 Frequently Asked Questions (FAQ)	64
C.2 Documentation	64
C.3 Contact Information	65
C.4 Warranty and RMA Information	65
Index	66

1 Product Overview

1.1 How to Identify This Product

To identify the InformaCast Enabled Wall Mount Speaker, look for a model number label similar to the one shown in [Figure 1-1](#). The model number on the label should be **011505**.

Figure 1-1. Model Number Label

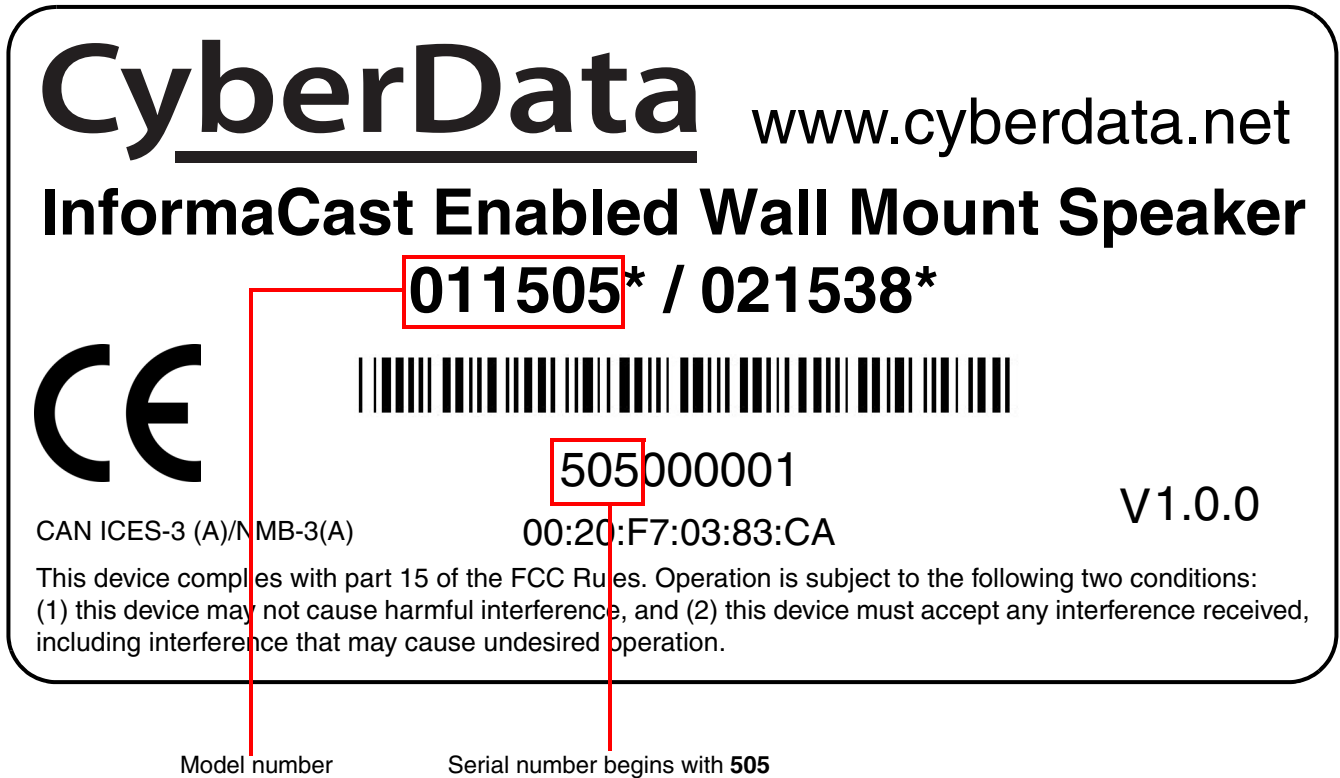

1.2 Typical Configuration

Figure 1-2 shows a typical configuration for the InformaCast Enabled Wall Mount Speaker.

Figure 1-2. Typical Configuration

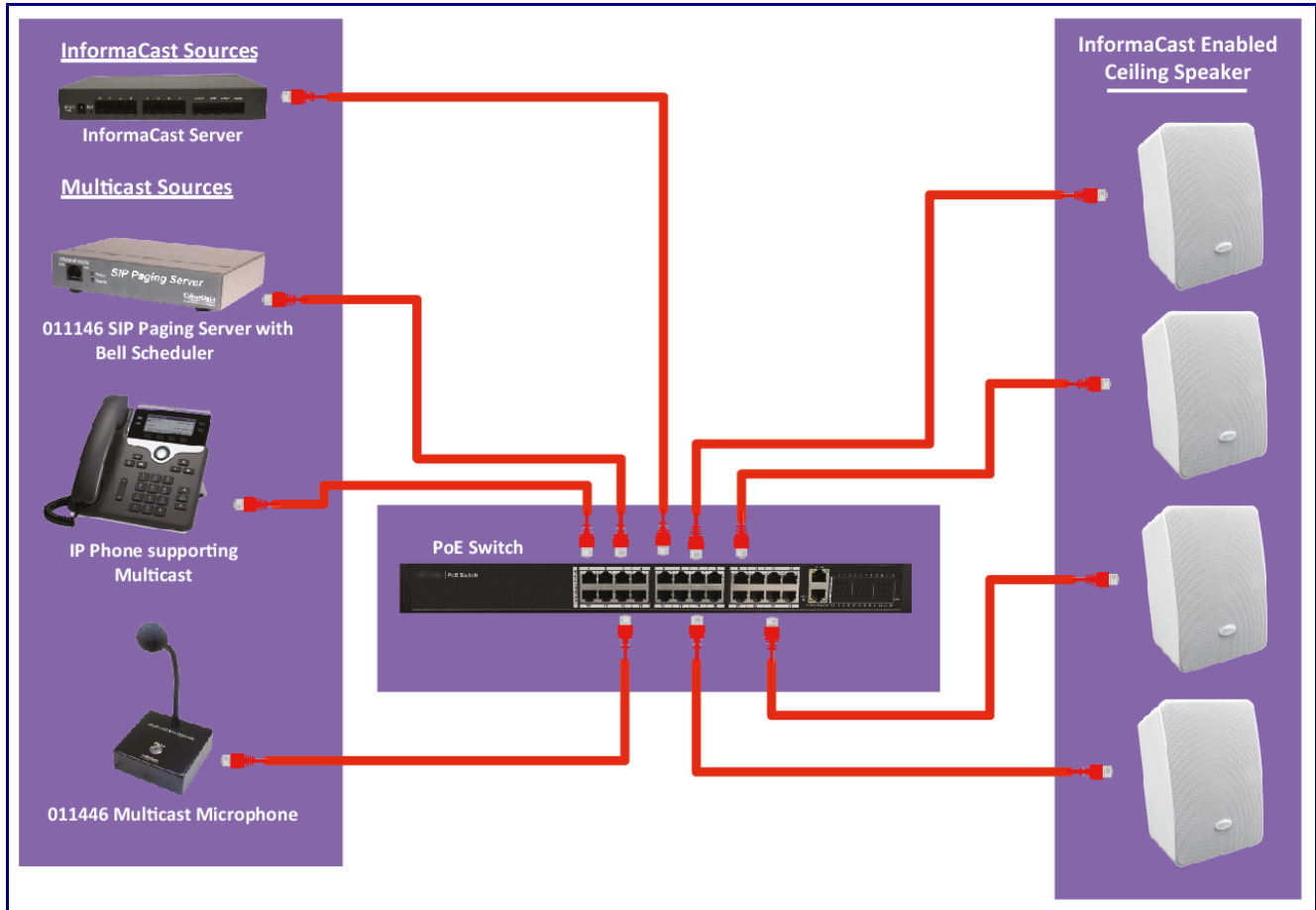

1.3 Product Features

- Capable of receiving Singlewire InformaCast and multicast messages
 - Supports Singlewire InformaCast High Quality Audio
 - Supports audio prioritization for 10 multicast paging groups
 - Can receive pages directly from Poly phones as well as other devices that can send standard multicast
-
- Network-adjustable speaker volume
 - High efficiency speaker driver
 - Small footprint
-
- TLS security for autoprovisioning and web-based configuration
 - 802.11q VLAN tagging
 - Configurable event generation for device health and status monitoring
 - User upgradeable firmware via web interface or autoprovisioning

1.4 Supported Protocols

The InformaCast Enabled Ceiling Speaker supports:

- Multicast
- Singlewire Informacast
- Singlewire Failover
- HTTP Web-based configuration
 - Provides an intuitive user interface for easy system configuration and verification of speaker operations.
- DHCP Client
 - Dynamically assigns IP addresses in addition to the option to use static addressing.
- HTTP TCP Post auto-updating event notification in XML format
- TLS 1.2
- TFTP Client
 - Facilitates hosting for the configuration file for Autoprovisioning.
- Audio Encodings
 - PCMU (G.711 μ -law)
 - PCMA (G.711 a-law)
 - G.729

1.5 Product Specifications

Table 1-1. Product Specifications

Category	Specification
Ethernet I/F	10/100 Mbps
Protocol	RTP
Notification Software	Singlewire InformaCast v4.0 and above
Power Input	PoE 802.3af
Audio Output	802.3af - SPL 98 dB @ 1 meter
Payload types	G.711 a-law, G.711 μ -law, and G.729
Network Security	TLS/SSL 1.2
Operating Range	Temperature: -40° C to 55° C (-40° F to 131° F) Humidity: 5-95%, non-condensing
Storage Temperature	-40° C to 70° C (-40° F to 158° F)
Storage Altitude	Up to 15,000 ft. (4573 m)
Dimensions	6.42 in. [163 mm] Length 5.39 in. [137 mm] Width 9.18 in. [233 mm] Height
Weight	3.8 lbs [1.72 kg]
Boxed Weight	4.4 lbs [1.96 kg]
Compliance	CE; EMC Directive - Class A EN 55032 & EN 55024, LV Safety Directive- EN 60950-1, RoHS Compliant, FCC; Part 15 Class A, Industry Canada; ICES-3 Class A, IEEE 802.3 Compliant
Warranty	2 Years Limited
Part number	011505

1.6 Compliance

1.6.1 CE Testing

CE testing has been performed according to EN ISO/IEC 17050 for Emissions, Immunity, and Safety.

Note You can download the Declaration of Conformity document from the **Downloads** tab of the product's webpage.

1.6.2 FCC Statement

This equipment has been tested and found to comply with the limits for a Class B digital device, pursuant to part 15 of the FCC Rules. These limits are designed to provide reasonable protection against harmful interference when the equipment is operated in a commercial environment. This equipment generates, uses, and can radiate radio frequency energy and, if not installed and used in accordance with the instruction manual, may cause harmful interference to radio communications. Operation of this equipment in a residential area is likely to cause harmful interference in which case the user will be required to correct the interference at his own expense.



2 Installing the Multicast Ceiling Speaker

2.1 Parts List

Table 2-1 illustrates the parts for each speaker and includes kits for the drop ceiling and drywall mounting.

Note The installation template for the Multicast Ceiling Speaker is located on the *Installation Quick Reference Guide* that is included in the packaging with each speaker.

Table 2-1. Parts

Quantity	Part Name	Illustration
1	Multicast Ceiling Speaker Assembly	
1	Installation Quick Reference Guide	

2.2 Device Configuration

Set up and configure each speaker *before* you mount it.

CyberData delivers each speaker with the following factory default values:

Table 2-2. Factory Network Default Settings—Default of Network

Parameter	Factory Default Setting
IP Addressing	DHCP
IP Address ^a	10.10.10.10
Web Access Username	admin
Web Access Password	admin
Subnet Mask ^a	255.0.0.0
Default Gateway ^a	10.0.0.1

a. Default if there is not a DHCP server present.

2.2.1 Connect Power to the Speaker

Figure 2-1 through Figure 2-2 illustrates how to connect power to the Multicast Ceiling Speaker.

2.2.1.1 Multicast Ceiling Speaker to a 802.3af Compliant PoE Switch

Figure 2-1 illustrates how to connect the Multicast Ceiling Speaker to a 802.3af compliant PoE switch via a Cat 5 Ethernet cable.

Figure 2-1. Multicast Ceiling Speaker to a 802.3af Compliant PoE Switch

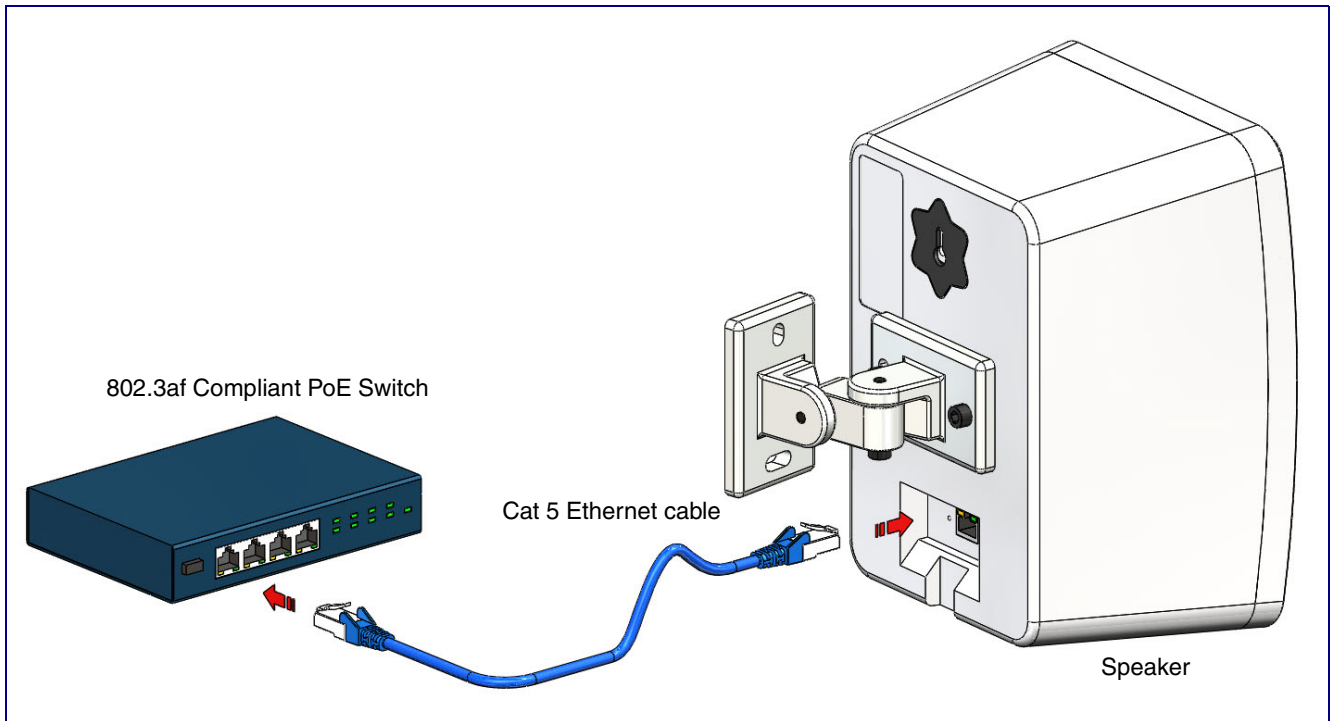

2.2.1.2 Multicast Ceiling Speaker (with PoE Injector) to a 802.3af Compliant PoE Switch

In [Figure 2-2](#), if a PoE switch is not available, you will need a PoE Injector, part #010867A (ordered separately). A PoE Injector is a power supply solution for those who have a standard Non PoE Switch.

Figure 2-2. Multicast Ceiling Speaker (with PoE Injector) to a Non PoE Switch

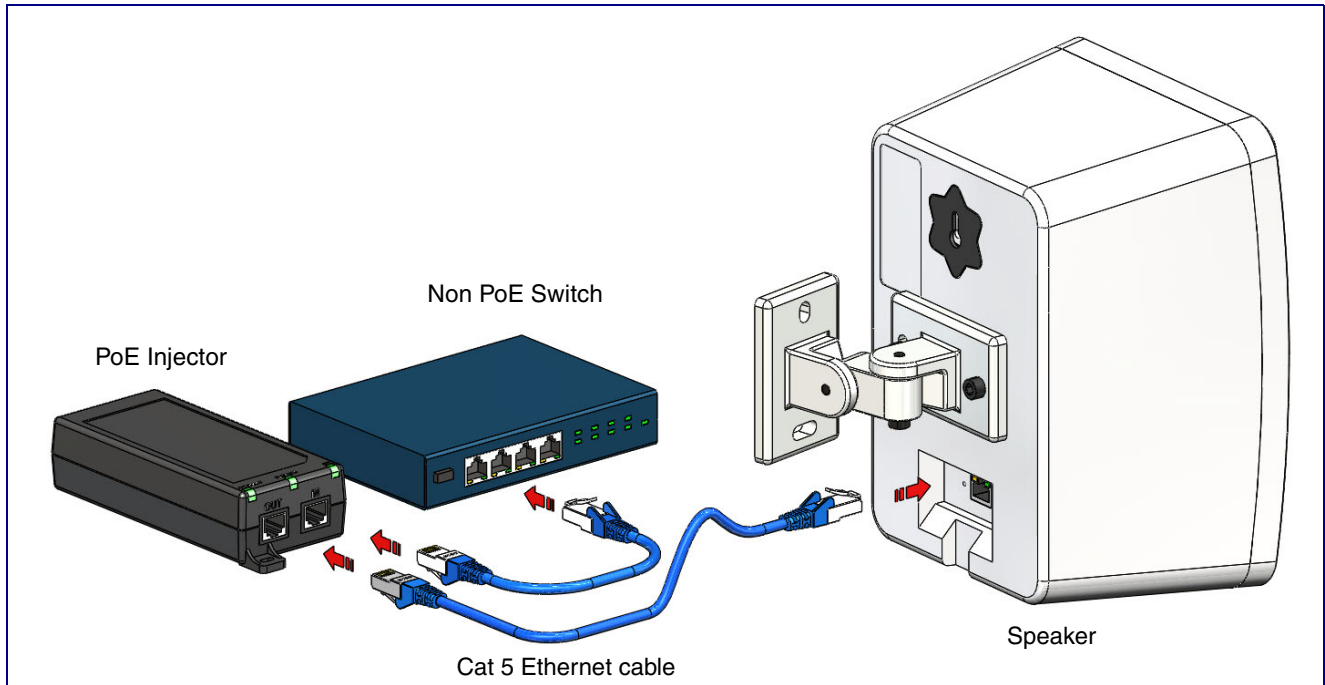

2.2.2 Confirm that the Speaker is Operational and Linked to the Network

After connecting the speaker to the 802.3af compliant Ethernet hub, the LEDs on the speaker face confirm that the speaker is operational and linked to the network.

Figure 2-3. Status and Activity LEDs

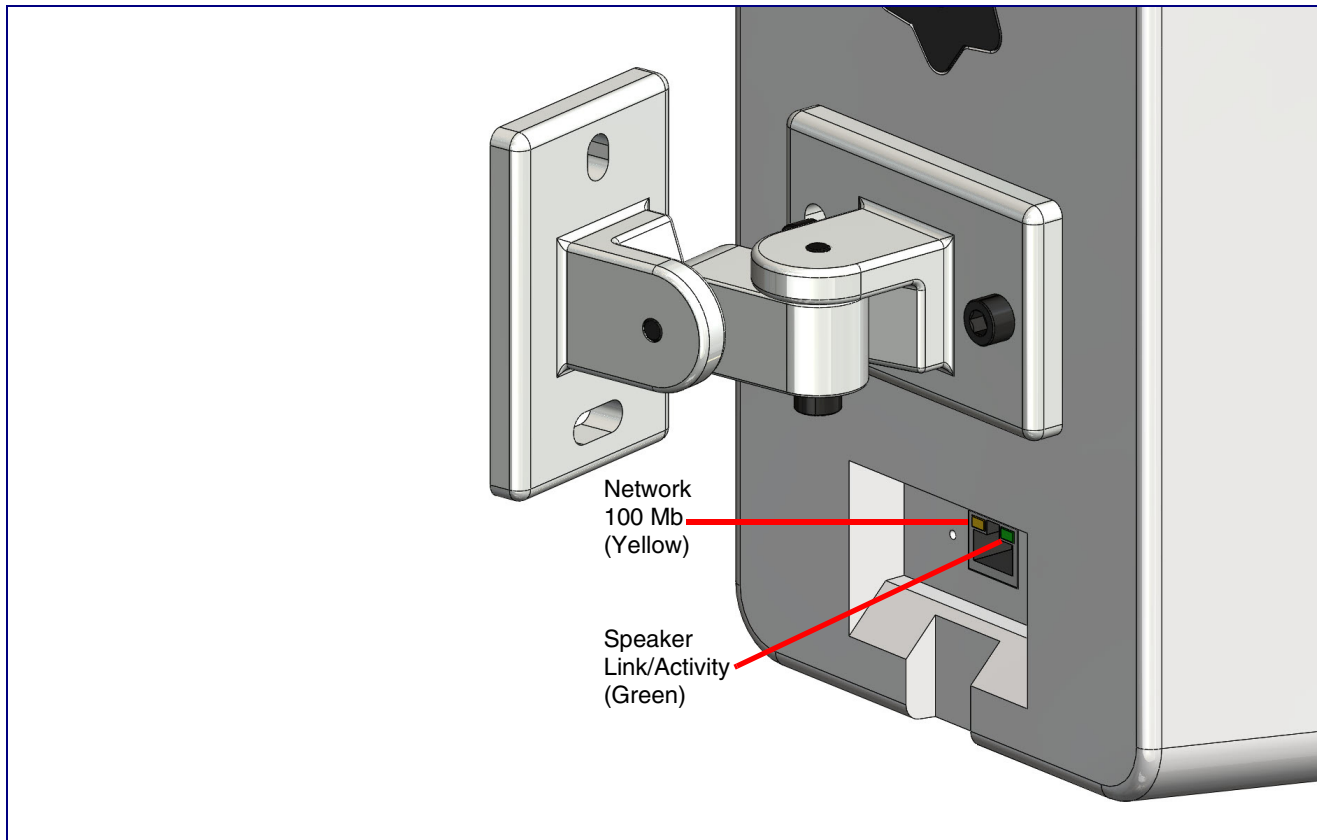

2.2.2.1 Link/Activity LED

After supplying power to the speaker:

1. The green Link/Activity LED comes on immediately to show that there is a good network connection, and then blinks to show network activity.
2. After about 23 seconds with a static IP address (or 27 seconds if the board is set to use DHCP), the speaker should be ready.

Note If the board is set to use DHCP and there is not a DHCP server available on the network, it will try 12 times with a three second delay between tries and eventually fall back to the programmed static IP address (by default 10.10.10.10). This process will take approximately 80 seconds.

2.2.2.2 100 Mb LED

- The yellow **100 Mb** LED is illuminated when the network 100 Mb link to the speaker is established.

2.2.3 Confirm the IP Address and Test the Audio

2.2.3.1 Reset Test Function Management (RTFM) Button

When the speaker is operational and linked to the network, use the Reset Test Function Management (RTFM) button (Figure 2-4) on the speaker face to announce and confirm the speaker's IP Address and test that the audio is working.

Figure 2-4. RTFM Button

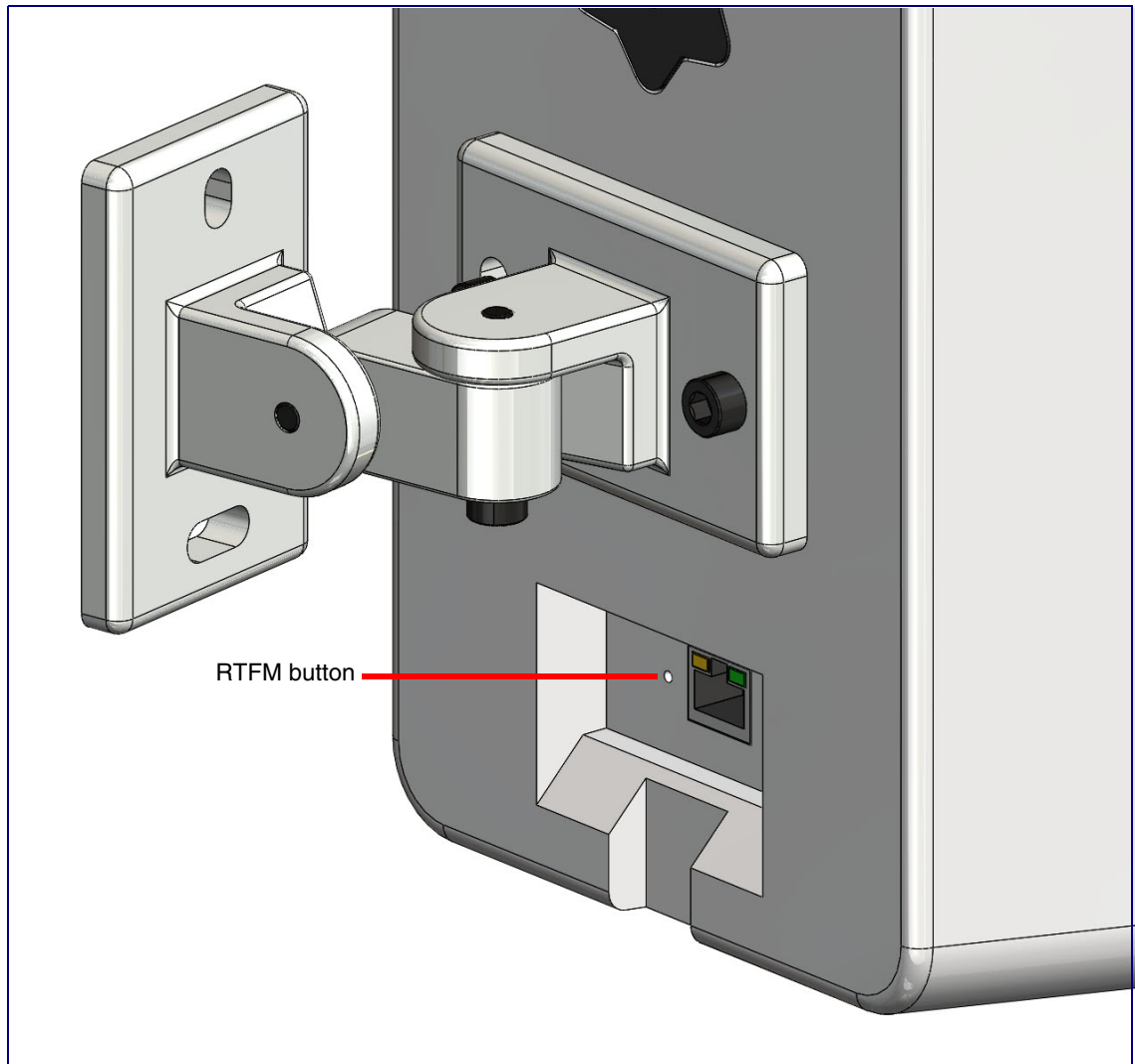

To announce a speaker's current IP address, use an instrument through the hole to press and release the RTFM button within a five second window.

Note The speaker will use DHCP to obtain the new IP address (DHCP-assigned address or default to 10.10.10.10 if a DHCP server is not present).

Note Pressing and holding the RTFM button for longer than five seconds will restore the speaker to the factory default settings.

2.2.4 How to Set the Factory Default Settings

2.2.4.1 RTFM Button

When the speaker is operational and linked to the network, use the Reset Test Function Management (RTFM) button (Figure 2-5) on the speaker face to set the factory default settings.

Figure 2-5. RTFM Button

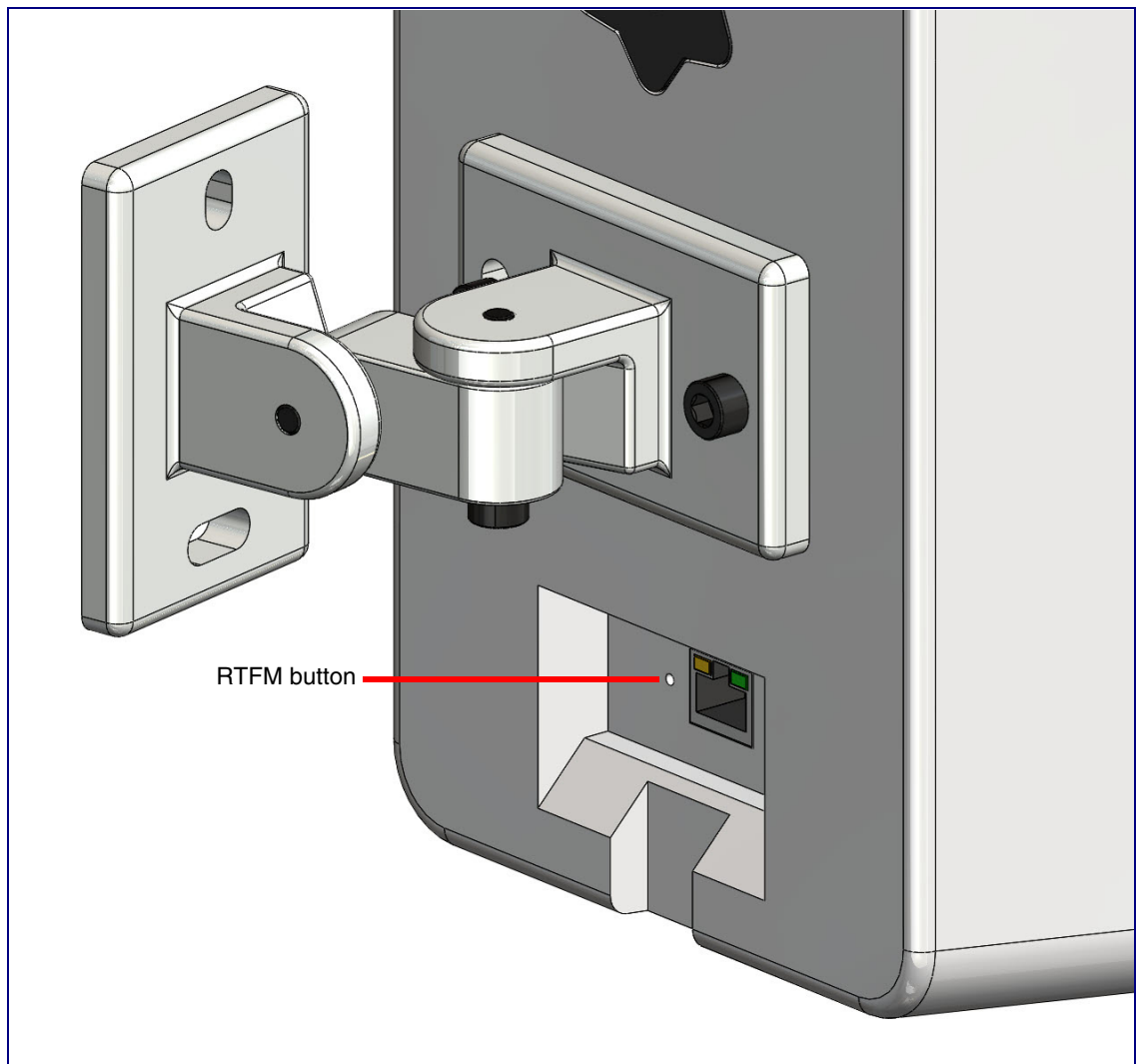

To set the factory default settings:

1. Press and hold the **RTFM** button for more than five seconds.
2. The speaker announces that it is restoring the factory default settings.

Note The speaker will use DHCP to obtain the new IP address (DHCP-assigned address or default to 10.10.10.10 if a DHCP server is not present).

2.3 Configure the Multicast Ceiling Speaker Parameters

To configure the Multicast Ceiling Speaker online, use a standard web browser.

Configure each Multicast Ceiling Speaker and verify its operation *before* you mount it. When you are ready to mount an Multicast Ceiling Speaker, refer to [Appendix A, "Mounting the Speaker"](#) for instructions.

2.3.1 Factory Default Settings

All Multicast Ceiling Speakers are initially configured with the following default IP settings:

When configuring more than one Multicast Ceiling Speaker, attach the Multicast Ceiling Speakers to the network and configure one at a time to avoid IP address conflicts.

Table 2-3. Factory Default Settings





Parameter	Factory Default Setting
IP Addressing	DHCP
IP Address ^a	10.10.10.10
Web Access Username	admin
Web Access Password	admin
Subnet Mask ^a	255.0.0.0
Default Gateway ^a	10.0.0.1

a. Default if there is not a DHCP server present.

2.3.2 Multicast Ceiling Speaker Web Page Navigation

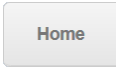
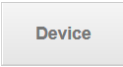
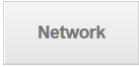
Table 2-4 shows the navigation buttons that you will see on every Multicast Ceiling Speaker web page.

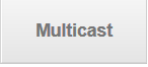
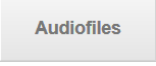
Table 2-4. Web Page Navigation

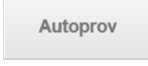
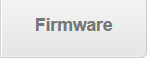
Web Page Item	Description
	Link to the Home page.
	Link to the Device page.
	Link to the Network page.
	Link to the SSL page.
	Link to the Multicast page.
	Link to the Audiofiles page.
	Link to the Events page.
	Link to the Autoprovisioning page.
	Link to the Firmware page.

2.3.3 Using the Toggle Help Button

The **Toggle Help** button allows you to see a short description of some of the settings on the webpage. To use the **Toggle Help** button, do the following:

1. Click on the **Toggle Help** button that is on the UI webpage. See [Figure 2-6](#) and [Figure 2-7](#).

Figure 2-6. Toggle/Help Button



2. You will see a question mark (?) appear next to each web page item that has been provided with a short description by the Help feature. See [Figure 2-7](#).

Figure 2-7. Toggle Help Button and Question Marks

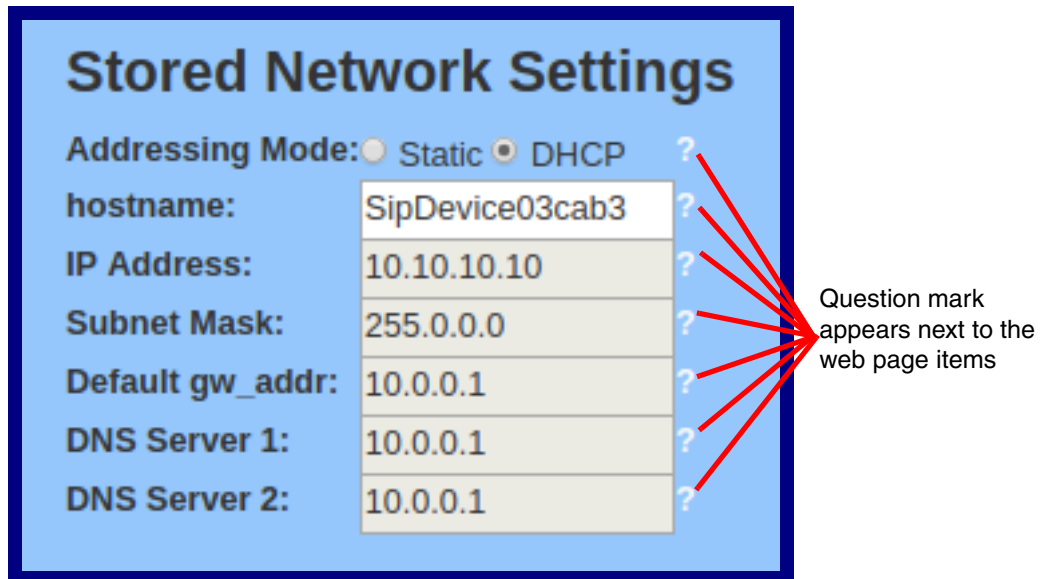

3. Move the mouse pointer to hover over the question mark (?), and a short description of the web page item will appear. See Figure 2-8.

Figure 2-8. Short Description Provided by the Help Feature

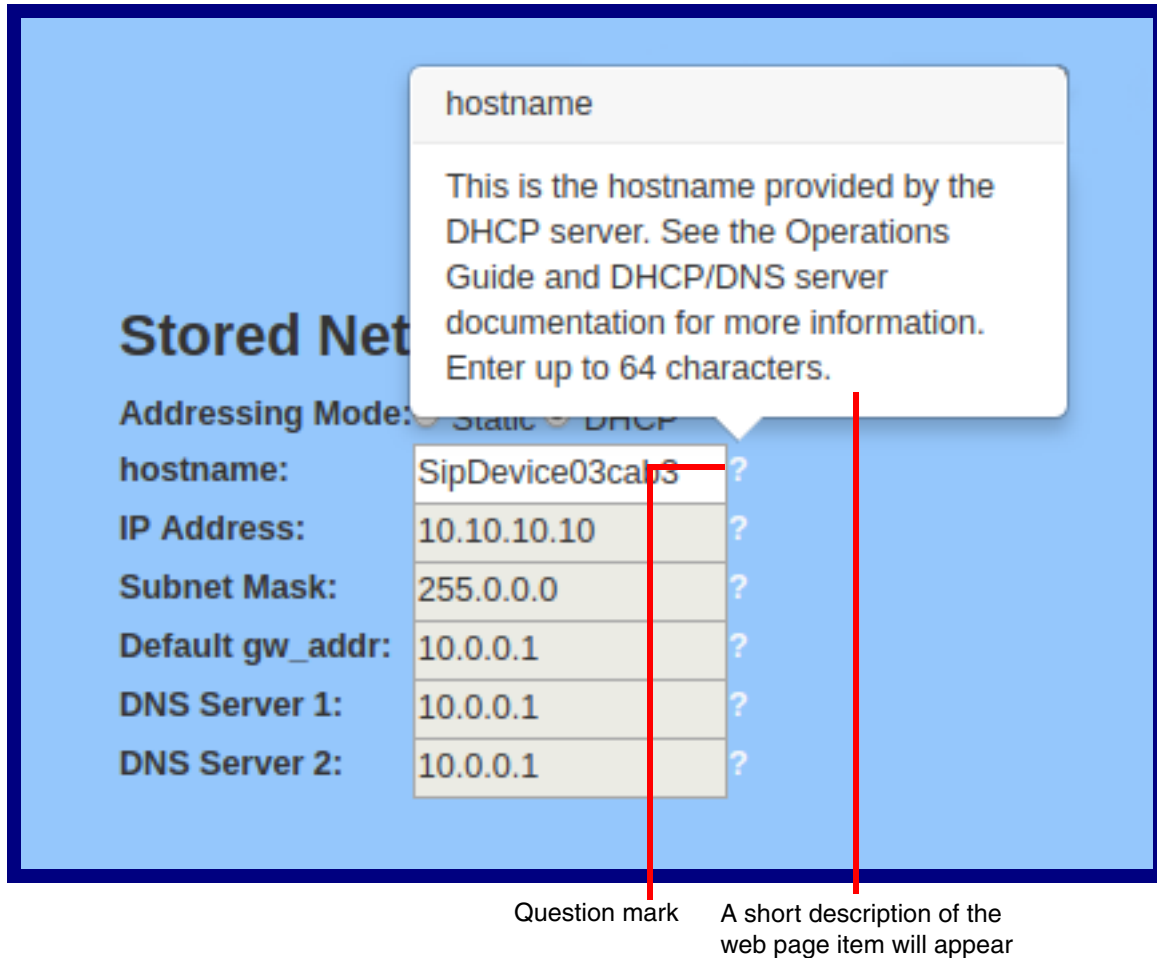

2.3.4 Log in to the Configuration Home Page

1. Open your browser to the Multicast Ceiling Speaker IP address.

Note If the network does not have access to a DHCP server, the device will default to an IP address of 10.10.10.10.

Note Make sure that the PC is on the same IP network as the Multicast Ceiling Speaker.

Note You may also download CyberData's VoIP Discovery Utility program which allows you to easily find and configure the default web address of the CyberData VoIP products.

CyberData's VoIP Discovery Utility program is available at the following website address:

<https://www.cyberdata.net/pages/discovery>

Note The device ships in DHCP mode. To get to the **Home** page, use the discovery utility to scan for the device on the network and open your browser from there.

2. When prompted, use the following default **Web Access Username** and **Web Access Password** to access the **Home Page** (Figure 2-9):

Web Access Username: **admin**

Web Access Password: **admin**

Figure 2-9. Home Page

The screenshot shows the 'Home' page of the InformaCast Enabled Speaker configuration interface. At the top, there is a navigation menu with tabs for Home, Device, Network, SSL, Multicast, Audiofiles, Events, Autopro, and Firmware. The main heading is 'InformaCast Enabled Speaker'. The page is divided into several sections: 'Current Status' (Serial Number: 505000001, Mac Address: 00:20:f7:04:20:eb, Firmware Version: v1.1.0, Partition 2: v1.1.0, Partition 3: v1.1.0, Booting From: partition 2, with a 'Boot From Other Partition' button), 'Admin Settings' (Username: admin, Password: ****, Confirm Password: ****), 'Import Settings' (Browse... button, No file chosen, Import Config button), 'Export Settings' (Export Config button), and 'Singlewire Status' (Boot Time: 2019/06/25 11:55:47, Current Time: 2019/06/26 12:52:32, IC Servers: 10.0.1.195, 10.0.1.196, Configuration File: InformaCastSpeaker.cfg, B'casts Accepted: 0, B'casts Rejected: 0, B'casts Active: 0). At the bottom, there are 'Save', 'Reboot', and 'Toggle Help' buttons. The 'Multicast Volume' is set to 4 and 'Event Reporting' is Disabled.

3. On the **Home** page, review the setup details and navigation buttons described in [Table 2-5](#).

Note The question mark icon (?) in the following table shows which web page items will be defined after the **Toggle Help** button is pressed.

Table 2-5. Home Page Overview







Web Page Item	Description
Admin Settings	
Username ?	The username to access the web interface. Enter up to 25 characters.
Password ?	The password to access the web interface. Enter up to 25 characters.
Confirm Password ?	Confirm the web interface password.
Current Status	
Serial Number	Shows the device serial number.
Mac Address	Shows the device Mac address.
Firmware Version	Shows the current firmware version.
Partition 2	Contains a complete copy of bootable software.
Partition 3	Contains an alternate, complete copy of bootable software.
Booting From	Indicates the partition currently used for boot.
	Allows the user to boot from the alternate partition.
IP Addressing	Shows the current IP addressing setting (DHCP or static).
IP Address	Shows the current IP address.
Subnet Mask	Shows the current subnet mask address.
Default Gateway	Shows the current default gateway address.
DNS Server 1	Shows the current DNS Server 1 address.
DNS Server 2	Shows the current DNS Server 2 address.
Multicast Volume	Shows the current Multicast volume level.
Event Reporting	Shows the current status of the Event Reporting mode.
Singlewire Settings	
Boot Time	Shows the boot time.
Current Time	Shows the current time.
IC Servers	Shows the InformaCast server IP addresses.
Configuration File	Shows the configuration file.
B'casts Accepted	Shows the number of B'casts accepted.
B'casts Rejected	Shows the number of B'casts rejected.
B'casts Active	Shows the number of active B'casts.
Import Settings	
	Use this button to select a configuration file to import.

Table 2-5. Home Page Overview (continued)

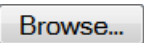
Web Page Item	Description
	After selecting a configuration file, click Import to import the configuration from the selected file. Then, click Save and Reboot to store changes.
Export Settings	
	Click Export to export the current configuration to a file.
	Click the Save button to save your configuration settings.
	Click on the Reboot button to reboot the system.
	Click on the Toggle Help button to see a short description of some of the web page items. First click on the Toggle Help button, and you will see a question mark (?) appear next to some of the web page items. Move the mouse pointer to hover over a question mark to see a short description of a specific web page item.

2.3.5 Configure the Device

1. Click the **Device** menu button to open the **Device** page. See [Figure 2-10](#).

Figure 2-10. Device Configuration Page

Home Device Network SSL Multicast Audiofiles Events Autopro Firmware

InformaCast Enabled Speaker

Volume Settings (0-9)
Multicast Volume:
InformaCast Volume: Set on the Singlewire server

Misc Settings
Device Name:
Disable HTTPS (NOT recommended):

Clock Settings
Enable NTP:
NTP Server:
Timezone:
Current Time: Tue, 25 Jun 2019 13:13:12

InformaCast Settings
InformaCast Address:

Save Reboot Toggle Help

Test Audio

2. On the **Device** page, you may enter values for the parameters indicated in [Table 2-6](#).

Note The question mark icon (?) in the following table shows which web page items will be defined after the **Toggle Help** button is pressed.

Table 2-6. Device Page Parameters





Web Page Item	Description
Volume Settings (0-9)	
Multicast Volume ?	Set the speaker volume for multicast audio streams. A value of 0 will mute the speaker during multicasts. Note: You can change this setting without rebooting the device.
Clock Settings	
Enable NTP ?	Sync device's local time with the specified NTP Server.
NTP Server ?	Use this field to set the address (in IPv4 dotted decimal notation or as a canonical name) for the NTP Server. This field can accept canonical names of up to 64 characters in length.
Timezone	Enter the tz database string of your timezone. Examples: America/Los_Angeles America/New_York Europe/London America/Toronto See https://en.wikipedia.org/wiki/List_of_tz_database_time_zones for a full list of valid strings.
Current Time	Displays the current time.
Misc Settings	
Device Name ?	Type the device name. Enter up to 25 characters.
Disable HTTPS (NOT recommended) ?	Disables the encrypted connection to the webpage. We do not recommend disabling HTTPS for security reasons.
InformaCast Settings	
InformaCast Address ?	Use this field to set the address of your InformaCast server. This will override any InformaCast server addresses received via SLP or DHCP. If using TFTP for configuration, simply enter an IP address (eg. 10.0.1.195) If using HTTP for configuration, enter the full URL to the path that contains the configuration file. Do not input the file name (e.g. http://10.0.1.195:8081/InformaCast/resources/). If the HTTP protocol is not specified with http:// , then TFTP will be used.
	Click on the Test Audio button to do an audio test. When the Test Audio button is pressed, you will hear a voice message for testing the device audio quality and volume.
	Click the Save button to save your configuration settings.

Table 2-6. Device Page Parameters (continued)

Web Page Item	Description
	Click on the Reboot button to reboot the system.
	Click on the Toggle Help button to see a short description of some of the web page items. First click on the Toggle Help button, and you will see a question mark (?) appear next to some of the web page items. Move the mouse pointer to hover over a question mark to see a short description of a specific web page item.

2.3.6 Configure the Network Parameters

1. Click the **Network** menu button to open the **Network** page (Figure 2-11).

Figure 2-11. Network Configuration Page

The screenshot displays the Network Configuration page for an InformaCast Enabled Speaker. At the top, there is a navigation bar with tabs for Home, Device, Network, SSL, Multicast, Audiofiles, Events, Autoprov, and Firmware. The main heading is "InformaCast Enabled Speaker".

Stored Network Settings

Addressing Mode: Static DHCP

Hostname:	SipDevice0420eb
IP Address:	10.10.10.10
Subnet Mask:	255.0.0.0
Default Gateway:	10.0.0.1
DNS Server 1:	10.0.0.1
DNS Server 2:	10.0.0.1

VLAN Settings

VLAN ID (0-4095):	0
VLAN Priority (0-7):	0

Current Network Settings

IP Address:	10.10.1.228
Subnet Mask:	255.0.0.0
Default Gateway:	10.0.0.1
DNS Server 1:	10.0.1.56
DNS Server 2:	

Buttons: Save, Reboot, Toggle Help

- On the **Network** page, enter values for the parameters indicated in [Table 2-7](#).

Note The question mark icon (?) in the following table shows which web page items will be defined after the **Toggle Help** button is pressed.

Table 2-7. Network Configuration Parameters



Web Page Item	Description
Stored Network Settings	
Addressing Mode ?	Select either DHCP IP Addressing or Static Addressing by marking the appropriate radio button. DHCP Addressing mode is enabled on default and the device will attempt to resolve network addressing with the local DHCP server upon boot. If DHCP Addressing fails, the device will revert to the last known IP address or the factory default address if no prior DHCP lease was established. See Section 2.3.1, "Factory Default Settings" for factory default settings. Be sure to click Save and Reboot to store changes when configuring a Static address.
Hostname ?	This is the hostname provided by the DHCP server. See the DHCP/DNS server documentation for more information. Enter up to 64 characters.
IP Address ?	Enter the Static IPv4 network address in dotted decimal notation.
Subnet Mask ?	Enter the Subnet Mask in dotted decimal notation.
Default Gateway ?	Enter the Default Gateway IPv4 address in dotted decimal notation.
DNS Server 1 ?	Enter the primary DNS Server IPv4 address in dotted decimal notation.
DNS Server 2 ?	Enter the secondary DNS Server IPv4 address in dotted decimal notation.
Current Network Settings	
IP Address	Shows the current Static IP address.
Subnet Mask	Shows the current Subnet Mask address.
Default Gateway	Shows the current Default Gateway address.
DNS Server 1	Shows the current DNS Server 1 address.
DNS Server 2	Shows the current DNS Server 2 address.
VLAN Settings	
VLAN ID (0-4095) ?	Specify the IEEE 802.1Q VLAN ID number. Enter up to 4 digits. Note: The device supports 802.1Q VLAN tagging support. The switch port connected to the device will need to be in "trunking mode" for the VLAN tags to propagate.
VLAN Priority (0-7) ?	Specify the IEEE 802.1p VLAN priority level. Enter 1 digit. A value of 0 may cause the VLAN ID tag to be ignored.
	Click the Save button to save your configuration settings.
	Click on the Reboot button to reboot the system.

Table 2-7. Network Configuration Parameters (continued)

Web Page Item	Description
 A rectangular button with rounded corners and a thin border, containing the text "Toggle Help" in a sans-serif font.	<p>Click on the Toggle Help button to see a short description of some of the web page items. First click on the Toggle Help button, and you will see a question mark (?) appear next to some of the web page items. Move the mouse pointer to hover over a question mark to see a short description of a specific web page item.</p>

2.3.7 Configure the SSL Parameters

1. Click **SSL** menu button to open the **SSL** page (Figure 2-12).

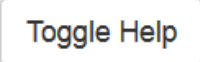
Figure 2-12. SSL Configuration Page

The screenshot shows the SSL Configuration page for an InformaCast Enabled Speaker. The navigation bar includes tabs for Home, Device, Network, SSL (selected), Multicast, Audiofiles, Events, Autoprov, and Firmware. The main heading is "InformaCast Enabled Speaker".

Server CAs

- Browse... No file chosen
- Import CA Certificate
- Restore Defaults
- Remove All
- Toggle Help

Client Certificate

```

subject=
countryName           = US
stateOrProvinceName  = California
localityName         = Monterey
organizationName     = Cyberdata
commonName            = Cyberdata_Dev
notBefore=Mar 22 16:50:02 2017 GMT
notAfter=Mar 20 16:50:02 2027 GMT
    
```

Client CA

Test SSL Connection

Server:

Port:

Test TLS Connection

List of Trusted CAs

1	CyberData_CA.pem	Info	Remove
2	DST_ACES_CA_X6.crt	Info	Remove
3	DST_Root_CA_X3.crt	Info	Remove
4	Deutsche_Telekom_Root_CA_2.crt	Info	Remove
5	DigiCert_Assured_ID_Root_CA.crt	Info	Remove
6	DigiCert_Assured_ID_Root_G2.crt	Info	Remove
7	DigiCert_Assured_ID_Root_G3.crt	Info	Remove
8	DigiCert_Global_Root_CA.crt	Info	Remove
9	DigiCert_Global_Root_G2.crt	Info	Remove
10	DigiCert_Global_Root_G3.crt	Info	Remove
11	DigiCert_High_Assurance_EV_Root_CA.crt	Info	Remove
12	DigiCert_Trusted_Root_G4.crt	Info	Remove
13	Equifax_Secure_CA.crt	Info	Remove
14	Equifax_Secure_Global_eBusiness_CA.crt	Info	Remove
15	Equifax_Secure_eBusiness_CA_1.crt	Info	Remove

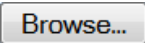

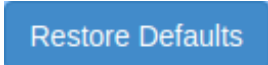

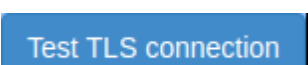

Figure 2-13. SSL Configuration Page

8	DigiCert_Global_Root_CA.crt	Info	Remove
9	DigiCert_Global_Root_G2.crt	Info	Remove
10	DigiCert_Global_Root_G3.crt	Info	Remove
11	DigiCert_High_Assurance_EV_Root_CA.crt	Info	Remove
12	DigiCert_Trusted_Root_G4.crt	Info	Remove
13	Equifax_Secure_CA.crt	Info	Remove
14	Equifax_Secure_Global_eBusiness_CA.crt	Info	Remove
15	Equifax_Secure_eBusiness_CA_1.crt	Info	Remove
16	GeoTrust_Global_CA.crt	Info	Remove
17	GeoTrust_Global_CA_2.crt	Info	Remove
18	GeoTrust_Primary_Certification_Authority.crt	Info	Remove
19	GeoTrust_Primary_Certification_Authority_-_G2.crt	Info	Remove
20	GeoTrust_Primary_Certification_Authority_-_G3.crt	Info	Remove
21	GeoTrust_Universal_CA.crt	Info	Remove
22	GeoTrust_Universal_CA_2.crt	Info	Remove
23	VeriSign_Class_3_Public_Primary_Certification_Authority_-_G4.crt	Info	Remove
24	VeriSign_Class_3_Public_Primary_Certification_Authority_-_G5.crt	Info	Remove
25	VeriSign_Universal_Root_Certification_Authority.crt	Info	Remove
26	Verisign_Class_1_Public_Primary_Certification_Authority.crt	Info	Remove
27	Verisign_Class_1_Public_Primary_Certification_Authority_-_G3.crt	Info	Remove
28	Verisign_Class_2_Public_Primary_Certification_Authority_-_G2.crt	Info	Remove
29	Verisign_Class_2_Public_Primary_Certification_Authority_-_G3.crt	Info	Remove
30	Verisign_Class_3_Public_Primary_Certification_Authority.crt	Info	Remove
31	Verisign_Class_3_Public_Primary_Certification_Authority_-_G3.crt	Info	Remove
32	thawte_Primary_Root_CA.crt	Info	Remove
33	thawte_Primary_Root_CA_-_G2.crt	Info	Remove
34	thawte_Primary_Root_CA_-_G3.crt	Info	Remove

2. On the **SSL** page, enter values for the parameters indicated in [Table 2-8](#).

Note The question mark icon (?) in the following table shows which web page items will be defined after the **Toggle Help** button is pressed.

Table 2-8. SSL Configuration Parameters

Web Page Item	Description
Server CAs	
	Use this button to select a configuration file to import.
	Click Browse to select a CA certificate to import. After selecting a server certificate authority (CA), click Import CA Certificate to import it to the list of trusted CAs. CAs are used to validate the certificate presented by the server when establishing a TLS connection.
	Restore Defaults will restore the default list of registered CAs and Remove All will remove all registered CAs.
	Restore Defaults will restore the default list of registered CAs and Remove All will remove all registered CAs.
Client Certificate	
Client CA ?	When doing mutual authentication this device will present a client certificate with these parameters. Right click and Save Link As... to get the Cyberdata CA used to sign this client certificate.
Test SSL Connection	
Server ?	The ssl test server address as a fully qualified domain name or in IPv4 dotted decimal notation.
Port ?	The ssl test server port. The supported range is 0-65536.
	Use this button to test a TLS connection to a remote server. This will attempt to make a socket connection to the configured test server and port and report the success or failure. This can be used to debug TLS connection issues.
List of Trusted CAs	
	Provides details of the certificate. After clicking on this button, the Certificate Info Window appears. See Section 2.3.7.1, "Certificate Info Window" .
	Removes this certificate from the list of trusted certificates. After clicking on this button, the Remove Server Certificate Window appears. See Section 2.3.7.2, "Remove Server Certificate Window" .

2.3.7.1 Certificate Info Window

The **Certificate Info Window** provides details of the certificate. This window appears after clicking on the **Info** button. See [Figure 2-14](#).

Figure 2-14. Certificate Info Window

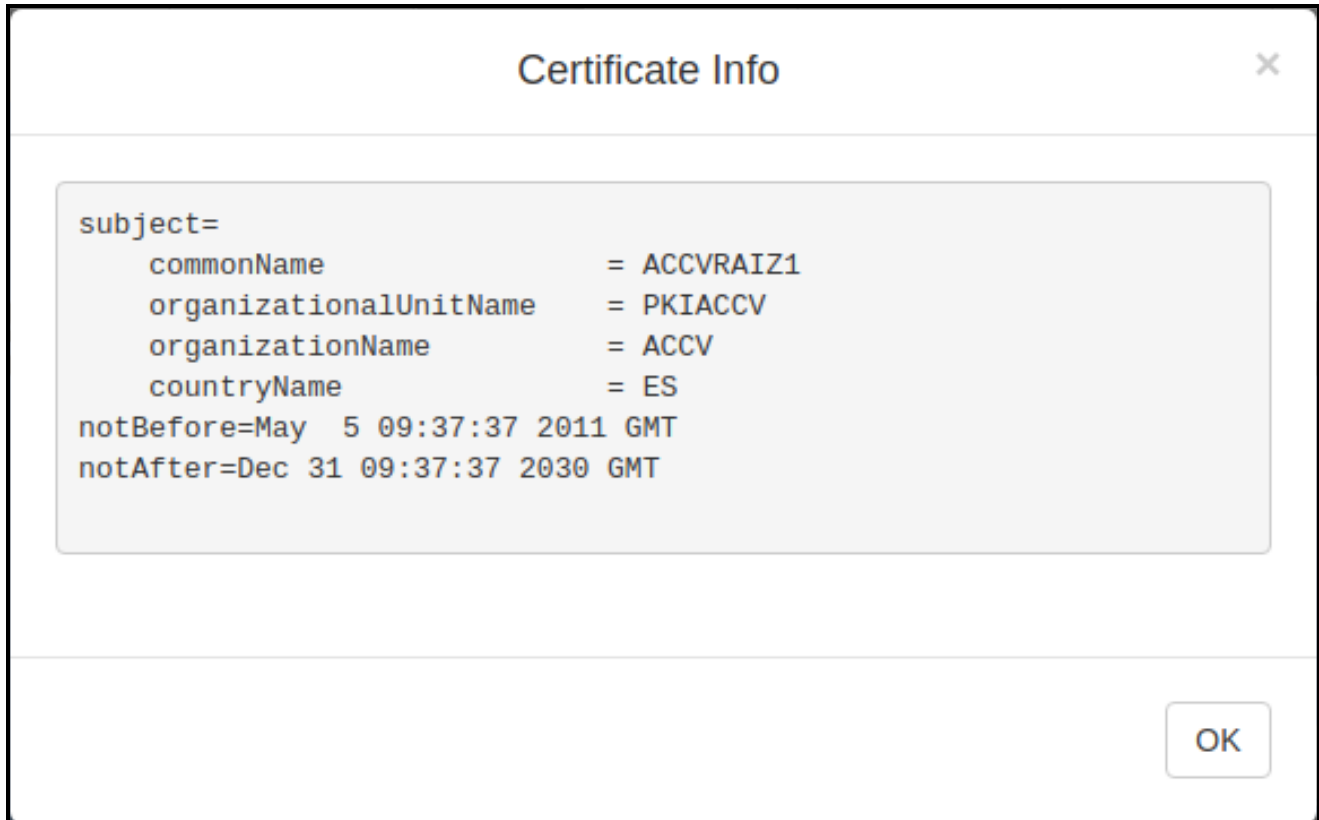

2.3.7.2 Remove Server Certificate Window

The **Remove Server Certificate Window** will ask if the user wants to remove a certificate from the list of trusted certificates. This window appears after clicking on the **Remove** button. See [Figure 2-15](#).

Figure 2-15. Remove Server Certificate Window

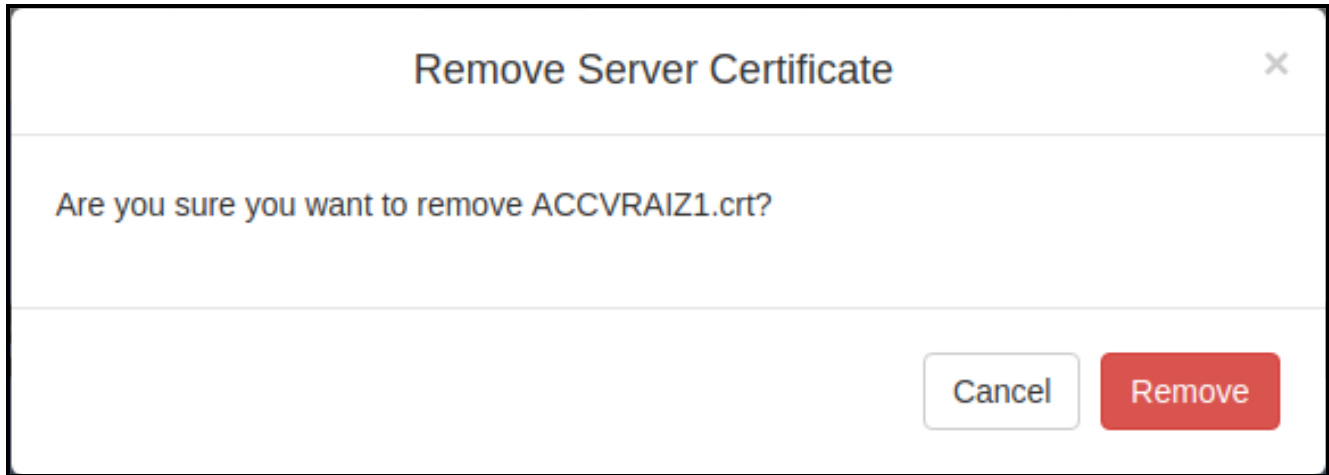

2.3.8 Configure the Multicast Parameters

The Multicast Configuration page allows the device to join up to ten paging zones for receiving ulaw/alaw encoded RTP audio streams.

A paging zone can consist of one or many CyberData multicast group-enabled products. There is no limit to how many speakers can be in a given paging zone. Each multicast group is defined by a multicast address and port number.

Each multicast group is assigned a priority, allowing simultaneously arriving pages to be serviced based on importance. Multicast groups are compatible with IGMP through version 3.

1. Click on the **Multicast** menu button to open the **Multicast** page. See [Figure 2-16](#).

Figure 2-16. Multicast Configuration Page

The screenshot shows the 'Multicast Speaker' configuration page. At the top is a navigation menu with buttons for Home, Device, Network, SSL, Multicast (selected), Audiofiles, Events, Autoprov, and Firmware. The main heading is 'Multicast Speaker' with a sub-heading 'Multicast Settings'. Below this is a table with columns: Priority, Address, Port, Name, and Beep. The table contains 10 rows of configuration data. Below the table are three dropdown menus for 'Polycom Default Channel' (set to 1), 'Polycom Priority Channel' (set to 24), and 'Polycom Emergency Channel' (set to 25). There are also several informational text blocks and two buttons at the bottom: 'Save' and 'Reboot'.

Priority	Address	Port	Name	Beep
0	239.168.3.1	2000	Background Music	<input type="checkbox"/>
1	239.168.3.2	3000	MG1	<input type="checkbox"/>
2	239.168.3.3	4000	MG2	<input type="checkbox"/>
3	239.168.3.4	5000	MG3	<input type="checkbox"/>
4	239.168.3.5	6000	MG4	<input type="checkbox"/>
5	239.168.3.6	7000	MG5	<input type="checkbox"/>
6	239.168.3.7	8000	MG6	<input type="checkbox"/>
7	239.168.3.8	9000	MG7	<input type="checkbox"/>
8	239.168.3.9	10000	MG8	<input type="checkbox"/>
9	239.168.3.10	11000	Emergency	<input type="checkbox"/>

Polycom Default Channel: 1
 Polycom Priority Channel: 24
 Polycom Emergency Channel: 25



SIP calls are considered priority 4.5
Port range can be from 2000-65535
Priority 9 is the highest and 0 is the lowest
A higher priority audio stream will always supersede a lower one
Priority 9 streams will play at maximum volume

Save Reboot

2. On the **Multicast** page, enter values for the parameters indicated in [Table 2-9](#).

Note The question mark icon (?) in the following table shows which web page items will be defined after the **Toggle Help** button is pressed..

Table 2-9. Multicast Page Parameters

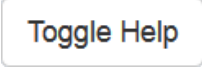
Web Page Item	Description
Priority	Indicates the priority for the multicast group. Priority 9 is the highest (emergency streams). 0 is the lowest (background music).
Address	Enter the multicast IP Address for this multicast group (15 character limit).
Port	Enter the port number for this multicast group (5 character limit [range can be from 2000 to 65535]). Note: The multicast ports have to be even values. The webpage will enforce this restriction.
Name	Assign a descriptive name for this multicast group (25 character limit).
Beep	When selected, the device will play a beep before multicast audio is sent.
Polycom Default Channel	When a default Polycom channel/group number is selected, the device will subscribe to the default channel for one-way group pages. Group Numbers 1-25 are supported. Or, select Disabled to disable this channel.
Polycom Priority Channel	When a priority Polycom channel/group number is selected, the device will subscribe to the priority channel for one-way group pages. Group Numbers 1-25 are supported. Or, select Disabled to disable this channel.
Polycom Emergency Channel	When an emergency Polycom channel/group number is selected, the device will subscribe to the default channel for one-way group pages. Group Numbers 1-25 are supported. Or, select Disabled to disable this channel.
	Click the Save button to save your configuration settings.
	Click on the Reboot button to reboot the system.
	Click on the Toggle Help button to see a short description of some of the web page items. First click on the Toggle Help button, and you will see a question mark (?) appear next to some of the web page items. Move the mouse pointer to hover over a question mark to see a short description of a specific web page item.

2.3.9 Configure the Audio Configuration Parameters

The **Audiofiles** page is used to add custom audio to the board. User uploaded audio will take precedence over the audio files shipped with the device.

1. Click on the **Audiofiles** menu button to open the **Audiofiles** page (Figure 2-17).

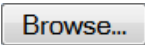



Figure 2-17. Audiofiles Page



2. On the **Audiofiles** page, enter values for the parameters indicated in [Table 2-10](#).

Note The question mark icon (?) in the following table shows which web page items will be defined after the **Toggle Help** button is pressed.

Table 2-10. Audiofiles Page Parameters

Web Page Item	Description
Available Space	Shows the space available for the user to save custom audio files if they want to change the message when the door or sensor is triggered.
Audio Files	
0-9	The name of the audio configuration option is the same as the spoken audio that plays on the board (24 character limit). '0' corresponds to the spoken word "zero." '1' corresponds to the spoken word "one." '2' corresponds to the spoken word "two." '3' corresponds to the spoken word "three." '4' corresponds to the spoken word "four."
Dot	Corresponds to the spoken word "dot." (24 character limit)
Audio Test	Corresponds to the message <i>"This is the CyberData IP speaker test message..."</i> (24 character limit)
Your IP Address is	Corresponds to the message "Your IP address is..." (24 character limit).
Rebooting	Corresponds to the spoken word "Rebooting" (24 character limit).
Restoring Default	Corresponds to the message "Restoring default" (24 character limit).
	Click on the Browse button to navigate to and select an audio file.
	The Play button will play that audio file.
	The Delete button will delete any user uploaded audio and restore the stock audio file.
	The Save button will download a new user audio file to the board once you've selected the file by using the Browse button. The Save button will delete any pre-existing user-uploaded audio files.

2.3.9.1 User-created Audio Files

User created audio files should be saved in the following format:

RIFF (little-endian) data, WAVE audio, Microsoft PCM, 16 bit, mono 8000 Hz

You can use the free utility *Audacity* to convert audio files into this format. See [Figure 2-18](#) through [Figure 2-20](#).

Figure 2-18. Audacity 1

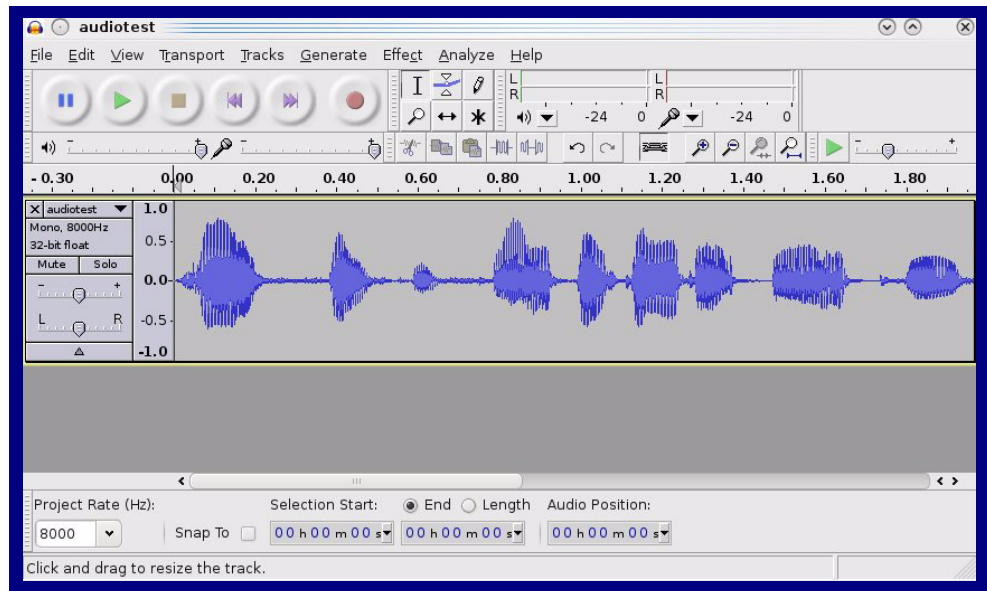
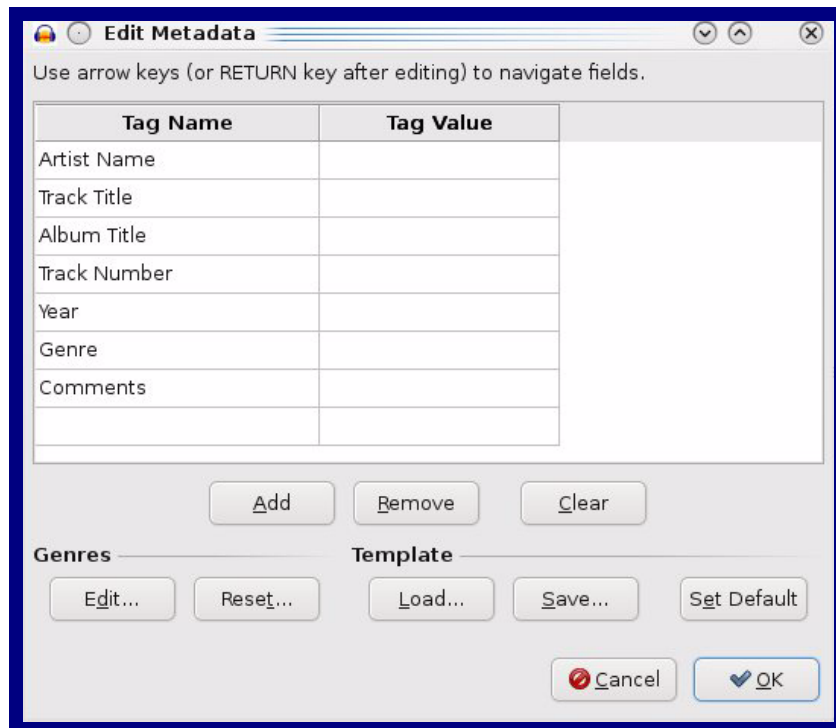

Figure 2-19. Audacity 2



When you export an audio file with Audacity, save the output as:

- **WAV (Microsoft) signed 16 bit PCM.**

Figure 2-20. WAV (Microsoft) signed 16 bit PCM

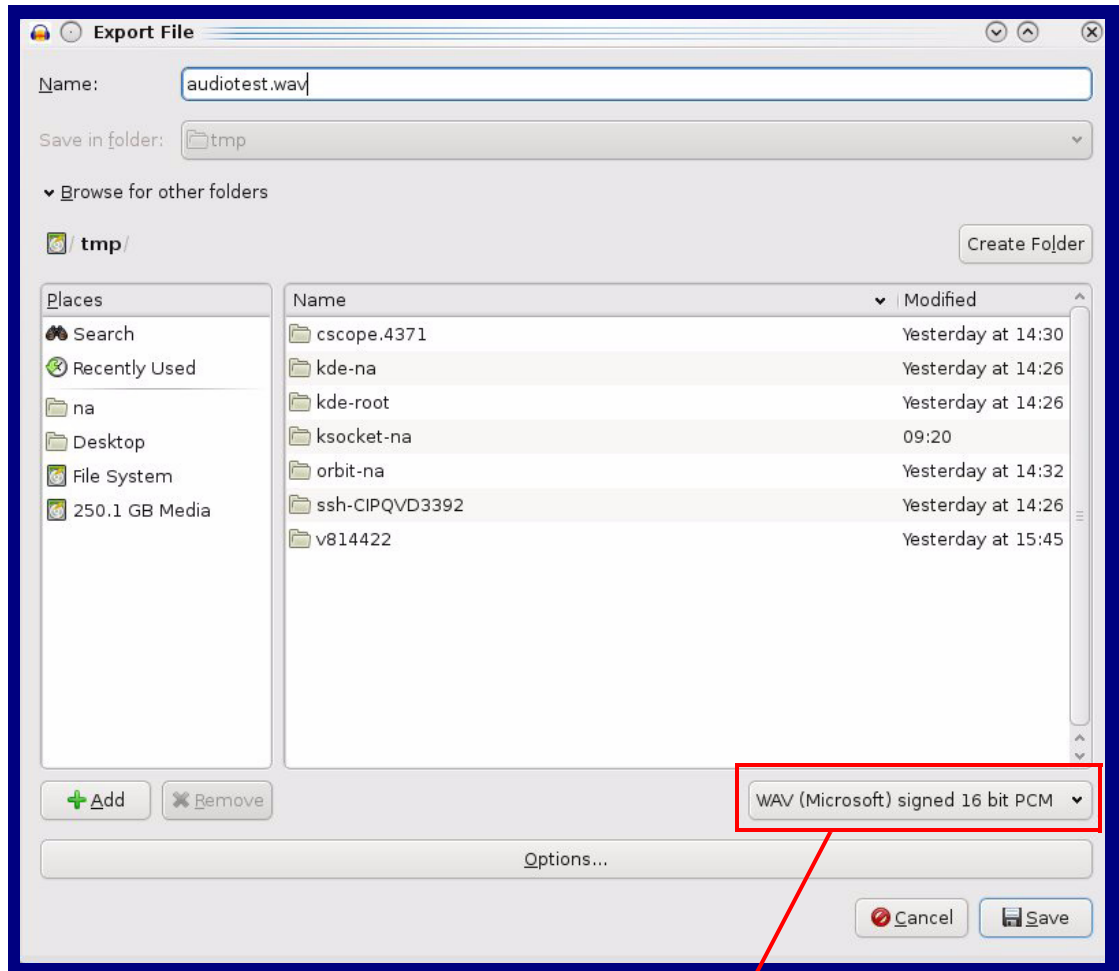

WAV (Microsoft) signed 16 bit PCM

2.3.10 Configure the Events Parameters

The **Events** page specifies a remote server that can be used to receive HTTP POST events when actions take place on the board.

1. Click on the **Events** menu button to open the **Events** page (Figure 2-21).

Figure 2-21. Event Configuration Page

Home Device Network SSL Multicast Audiofiles **Events** Autopro Firmware

InformaCast Enabled Speaker

Enable Event Generation:

Events

Enable Multicast Start Events:

Enable Multicast Stop Events:

Enable Power On Events:

Enable 60 Second Heartbeat:

Enable InformaCast Start Events:

Enable InformaCast Stop Events:

Event Server

Server IP Address: 10.0.0.250

Server Port: 8080



Server URL: xmlparse_engine

Save Reboot Toggle Help

2. On the **Events** page, enter values for the parameters indicated in [Table 2-11](#).

Note The question mark icon (?) in the following table shows which web page items will be defined after the **Toggle Help** button is pressed.

Table 2-11. Events Configuration Parameters

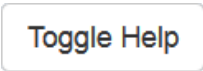
Web Page Item	Description
Enable Event Generation ?	The device will send HTTP POST events to the specified remote server and port number whenever a certain action takes place. Select an event type below to generate an HTTP POST event.
Events	
Enable Multicast Start Events ?	When selected, the device will report when the device starts playing a multicast audio stream.
Enable Multicast Stop Events ?	When selected, the device will report when the device stops playing a multicast audio stream.
Enable Power On Events ?	When selected, the device will report when it boots.
Enable 60 Second Heartbeat ?	When enabled, the device will report a Heartbeat event every 60 seconds. SIP registration is not required to generate Heartbeat events.
Enable Informacast Start Events ?	When selected, the device will report when a Start event has been received from the Singlewire server.
Enable Informacast Stop Events ?	When selected, the device will report when a Stop event has been received from the Singlewire server.
Event Server	
Server IP Address ?	The IPv4 address of the event server in dotted decimal notation.
Server Port ?	Specify the event server port number. The supported range is 0-65536. Enter up to 5 digits.
Server URL ?	Generally, the destination URL is the name of the application that receives the events and the string in the HTTP POST command. It can be a script used to parse and process the HTTP POST events. Enter up to 127 characters.
	Click the Save button to save your configuration settings.
	Click on the Reboot button to reboot the system.
	Click on the Toggle Help button to see a short description of some of the web page items. First click on the Toggle Help button, and you will see a question mark (?) appear next to some of the web page items. Move the mouse pointer to hover over a question mark to see a short description of a specific web page item.

2.3.10.1 Example Packets for Events

The server and port are used to point to the listening server and the 'Remote Event Server URL' is the destination URL (typically the script running on the remote server that's used to parse and process the POST events).

Note The XML is URL-encoded before transmission so the following examples are not completely accurate.

Here are example packets for every event:

```
POST xmlparse_engine HTTP/1.1
Host: 10.0.3.79
User-Agent: CyberData/1.1.0
Content-Length: 197
Content-Type: application/x-www-form-urlencoded

<?xml version="1.0" encoding="ISO-8859-1"?>
<cyberdata NAME='CyberData Device' MAC='0020f70015b6'>
<event>POWERON</event>
</cyberdata>
```

```
POST xmlparse_engine HTTP/1.1
Host: 10.0.3.79
User-Agent: CyberData/1.1.0
Content-Length: 199
Content-Type: application/x-www-form-urlencoded

<?xml version="1.0" encoding="ISO-8859-1"?>
<cyberdata NAME='CyberData Device' MAC='0020f70015b6'>
<event>HEARTBEAT</event>
</cyberdata>
```

```
POST xmlparse_engine HTTP/1.1
Host: 10.0.3.79
User-Agent: CyberData/1.1.0
Content-Length: 196
Content-Type: application/x-www-form-urlencoded

<?xml version="1.0" encoding="ISO-8859-1"?>
<cyberdata NAME='CyberData Device' MAC='0020f70015b6'>
<event>BUTTON</event>
</cyberdata>
```

```
POST xmlparse_engine HTTP/1.1
Host: 10.0.3.79
User-Agent: CyberData/1.1.0
Content-Length: 201
Content-Type: application/x-www-form-urlencoded

<?xml version="1.0" encoding="ISO-8859-1"?>
<cyberdata NAME='CyberData Device' MAC='0020f70015b6'>
<event>CALL_ACTIVE</event>
</cyberdata>
POST xmlparse_engine HTTP/1.1
Host: 10.0.3.79
```



```
User-Agent: CyberData/1.1.0
Content-Length: 205
Content-Type: application/x-www-form-urlencoded

<?xml version="1.0" encoding="ISO-8859-1"?>
<cyberdata NAME='CyberData Device' MAC='0020f70015b6'>
<event>CALL_TERMINATED</event>
</cyberdata>

POST xmlparse_engine HTTP/1.1
Host: 10.0.3.79
User-Agent: CyberData/1.1.0
Content-Length: 197
Content-Type: application/x-www-form-urlencoded

<?xml version="1.0" encoding="ISO-8859-1"?>
<cyberdata NAME='CyberData Device' MAC='0020f70015b6'>
<event>RINGING</event>
</cyberdata>

POST xmlparse_engine HTTP/1.1
Host: 10.0.3.79
User-Agent: CyberData/1.1.0
Content-Length: 234
Content-Type: application/x-www-form-urlencoded

<?xml version="1.0" encoding="ISO-8859-1"?>
<cyberdata NAME='CyberData Device' MAC='0020f70015b6'>
<event>MULTICAST_START</event>
<index>8</index>
</cyberdata>

POST xmlparse_engine HTTP/1.1
Host: 10.0.3.79
User-Agent: CyberData/1.1.0
Content-Length: 233
Content-Type: application/x-www-form-urlencoded

<?xml version="1.0" encoding="ISO-8859-1"?>
<cyberdata NAME='CyberData Device' MAC='0020f70015b6'>
<event>MULTICAST_STOP</event>
<index>8</index>
</cyberdata>

POST xmlparse_engine HTTP/1.1
Host: 10.0.3.79
User-Agent: CyberData/1.1.0
Content-Length: 234
Content-Type: application/x-www-form-urlencoded
<?xml version="1.0" encoding="ISO-8859-1"?>
<cyberdata NAME='CyberData Device' MAC='0020f70015b6'>
<event>RELAY_ACTIVATED</event>
</cyberdata>
POST xmlparse_engine HTTP/1.1
Host: 10.0.3.79
```

```
User-Agent: CyberData/1.1.0  
Content-Length: 234  
Content-Type: application/x-www-form-urlencoded  
<?xml version="1.0" encoding="ISO-8859-1"?>  
<cyberdata NAME='CyberData Device' MAC='0020f70015b6'>  
<event>RELAY_DEACTIVATED</event>  
</cyberdata>
```

```
POST xmlparse_engine HTTP/1.1  
Host: 10.0.3.79  
User-Agent: CyberData/1.1.0  
Content-Length: 234  
Content-Type: application/x-www-form-urlencoded  
<?xml version="1.0" encoding="ISO-8859-1"?>  
<cyberdata NAME='CyberData Device' MAC='0020f70015b6'>  
<event>NIGHTRINGING</event>  
</cyberdata>
```

2.3.11 Configure the Autoprovisioning Parameters

Autoprovisioning can be used to automatically configure your device. The autoprovisioning file is an xml file with the device configuration. Values found in this file will override values stored in on-board memory.

Note By default, the device will try to set up its configuration with autoprovisioning.

1. Click the **Autoprov** menu button to open the **Autoprovisioning** page. See [Figure 2-22](#).

Figure 2-22. Autoprovisioning Page

Home Device Network SSL Multicast Audiofiles Events **Autoprov** Firmware

InformaCast Enabled Speaker

Enable Autoprovisioning:

Autoprovisioning Server:

Autoprovisioning Filename:

Use ftp:

Verify Server Certificate

Username:

Password:

Autoprovisioning autoupdate (in minutes):

Autoprovision at time (HHMM):

Autoprovision when idle (in minutes > 10):

See the manual to learn how to use autoprovisioning to configure your device.
Autoprovisioning happens on boot.
The device will first look for a configured server address and filename.
If these haven't been configured, it will look for an autoprovisioning server in your list of DHCP options and try to download '0020f70420eb.xml' and if this fails, '000000cd.xml'.

Save Reboot Toggle Help

Download Template

Autoprovisioning log





```

2019-06-24 17:09:20 Autoprov: no autoprov triggers. Exiting...
2019-06-24 17:09:21 Autoprovisioning on boot
2019-06-24 17:09:21 Autoprov found server='https://10.0.0.242:4444' in dhcp option 43
2019-06-24 17:09:21 Autoprov looking for https://10.0.0.242:4444/0020f70420eb.xml
2019-06-24 17:09:21 Autoprov not verifying server certificate
2019-06-24 17:09:21 Autoprov: download failed
2019-06-24 17:09:21 Autoprov looking for 000000cd.xml at https://10.0.0.242:4444
2019-06-24 17:09:21 Autoprov looking for https://10.0.0.242:4444/000000cd.xml
2019-06-24 17:09:21 Autoprov not verifying server certificate
2019-06-24 17:09:22 Autoprov: download failed
    
```

- On the **Autoprovisioning** page, you may enter values for the parameters indicated in [Table 2-12](#).

Note The question mark icon (?) in the following table shows which web page items will be defined after the **Toggle Help** button is pressed.

Table 2-12. Autoprovisioning Page Parameters

Web Page Item	Description
Enable Autoprovisioning ?	The device will automatically fetch a configuration file, also known as the 'autoprovisioning file', based on the configured settings below.
Autoprovisioning Server ?	Enter the IPv4 address of the provisioning server in dotted decimal notation.
Autoprovisioning Filename ?	The autoprovisioning filename is the configuration filename. The default autoprovisioning filename is in the format of <mac address>.xml. Supported filename extensions are .txt, and .xml. The current filename is denoted by an asterisk at the bottom of the Autoprovisioning Page . Enter up to 256 characters. A file may have any name with an xml extension. If a file name is entered, the device will look for the specified file name, and only that file.
Use tftp ?	The device will use TFTP (instead of http) to download autoprovisioning files.
Verify Server Certificate ?	When using ssl to download autoprovisioning files, reject connections where the server address doesn't match the server certificate's common name.
Username ?	The username used to authenticate with an autoprovisioning server. Leave this field blank to disable authentication.
Password ?	The password used to authenticate with an autoprovisioning server. Leave this field blank to disable authentication.
Autoprovisioning Autoupdate (in minutes) ?	The reoccurring time (in minutes) the device will wait before checking for new autoprovisioning files. Enter up to 6 digits. A value of 0 will disable this option.
Autoprovision at time (HHMMSS) ?	The time of day the device will check for a new autoprovisioning file. The time must be 6 characters in length and in HHMMSS format. An empty value will disable this option.
Autoprovision when idle (in minutes > 10) ?	The idle time (in minutes greater than 10) after which the device will check for a new autoprovisioning file. Enter up to 6 digits. A value of 0 will disable this option.
	Click the Save button to save your configuration settings.
	Click on the Reboot button to reboot the system.
	Click on the Toggle Help button to see a short description of some of the web page items. First click on the Toggle Help button, and you will see a question mark (?) appear next to some of the web page items. Move the mouse pointer to hover over a question mark to see a short description of a specific web page item.
	Press the Download Template button to create an autoprovisioning file for the device. See Section 2.3.11.3, "Download Template Button"
Autoprovisioning log	The autoprovisioning log provides information about the latest autoprovisioning attempt (i.e. dhcp options and server accessed and files parsed or not found).

Note You must click on the **Save** button for the changes to take effect.

2.3.11.1 Autoprovisioning

On boot, the device will look for an autoprovisioning server configured on the [Autoprovisioning Page](#) or specified as a DHCP option. When it finds a server, it will try to download the following (in order of preference):

1. The file configured on the autoprovisioning page.
2. A file named according to its mac address (for example: 0020f7350058.xml).
3. The file 000000cd.xml

The file can be hosted using a standard web server (like apache, IIS, or nginx), and the device can download over SSL. The file server can be an ipv4 address in dotted decimal notation or a fully qualified domain name.

By default, the device will get its autoprovisioning server from the DHCP options. See [Section 2.3.11.2, "Sample dhcpd.conf"](#) for an example of how to configure dhcpd to offer autoprovisioning server addresses. If multiple options are set, the device will attempt to download autoprovisioning files from every server.

The DHCP option determines the protocol used to download the autoprovisioning file. The device looks for DHCP options in the following order:

1. Option 43 - a FQDN or an IP address to an http server
2. Option 72 - an IP address to an http server
3. Option 150 - an IP address to a tftp server
4. Option 66 - an IP address to a tftp server or if the entry starts with 'http', a FQDN to a http server.

You can download an autoprovisioning template file from the [Autoprovisioning Page](#) using the **Download Template** button (see [Table 2-12](#)). This file contains every configuration option that can be set on the board.

Autoprovisioning files can contain the whole configuration or a subset of this file. The first autoprovisioning file can also contain links to other autoprovisioning files.

The `<MiscSettings>` section contains some examples of additional autoprovisioning files:

```
<MiscSettings>
    <DeviceName>CyberData VoIP Device</DeviceName>
<!-- <AutoprovFile>common.xml</AutoprovFile>-->
<!-- <AutoprovFile>sip_reg[macaddress].xml</AutoprovFile>-->
<!-- <AutoprovFile>audio[macaddress]</AutoprovFile>-->
<!-- <AutoprovFile>device[macaddress].xml</AutoprovFile>-->
</MiscSettings>
```

After downloading the first autoprovisioning file, the device will step through up to twenty additional `<AutoprovFile>` entries and try to download these files from the same server.

When the device finds a filename with the string `[macaddress]`, it will replace this string with the mac address.

As an example, the user has configured option 43 on their DHCP server to "http://example.com," and on their server, they have a file named **0020f7123456.xml** (the same as the mac address of the device).

The file 0020f7123456.xml contains:

```
<?xml version="1.0" encoding="utf-8" ?>
<specific>
  <MiscSettings>
    <DeviceName>Newname</DeviceName>
    <AutoprovFile>common.xml</AutoprovFile>
    <AutoprovFile>sip_reg[macaddress].xml</AutoprovFile>
    <AutoprovFile>audio[macaddress]</AutoprovFile>
    <AutoprovFile>device.xml</AutoprovFile>
  </MiscSettings>
</specific>
```

1. The device will first set it's name to 'Newname'.
2. It will try to download http://example.com/common.xml.
3. It will try to download http://example.com/sip_reg0020f7123456.xml.
4. It will try to download http://example.com/audio0020f7123456.
5. It will try to download http://example.com/device.xml.

The device is reconfigured every time it downloads a new file so if two files configure the same option the last one will be the one that is saved.

It is possible to autoprovision autoprovisioning values (for example, to disable autoprovisioning or to configure a time to check for new files).

Checking for New Autoprovisioning Files after Boot

The device will always check for an autoprovisioning files on boot but it can be configured to also check after a periodic delay, when idle, or at a specified time. When one of these options is set, the device will download its autoprovisioning files again, and if it finds any differences from the files it downloaded on boot, it will force a reboot and reconfigure.

The
Autoprovisioning
Filename

The autoprovisioning filename can contain a file, a file path, or a directory.

Table 2-13. Autoprovisioning File Name

Autoprovisioning Filename	Autoprovisioning Server	File Downloaded
config.xml	10.0.1.3	10.0.1.3/config.xml
/path/to/config.xml	10.0.1.3	10.0.1.3/path/to/config.xml
subdirectory/path/	10.0.1.3	10.0.1.3/subdirectory/path/0020f7020002.xml

TFTP options may not support subdirectories. If a directory is set in the filename field, firmware and audio files will also be downloaded from this subdirectory.

If the filename ends with a forward slash “/,” the device will treat it as a subdirectory.

For example:

The autoprovisioning server is set to “https://www.example.com”

The autoprovisioning filename is set to “cyberdata/”

On boot, the device will try to download:

https://www.example.com/cyberdata/0020f7123456.xml

...and if this fails:

https://www.example.com/cyberdata/000000cd.xml

Audio files and firmware files will also add “cyberdata” to the URL before downloading.

```

Autoprovisioning <FirmwareSettings>
Firmware Updates <FirmwareFile>505-uImage-ceilingsspeaker</FirmwareFile>
                  <FirmwareServer>10.0.1.3</FirmwareServer>
                  <OutdoorIntercom30>firmware_file_v9.3.0</OutdoorIntercom30>
                  <OutdoorIntercom31>firmware_file_v10.3.0</OutdoorIntercom31>
                  <CallButton31>firmware_file_v10.3.0</CallButton31>
                  </FirmwareSettings>

```

In the <FirmwareSettings> section, the <FirmwareServer> element can be used to specify a different server for hosting firmware files. When this element is not available, the device will try to download the file from the autoprovisioning server.

The device will use the filename to determine when to autoprovision firmware updates. The default configuration is blank, so the first time you set a value in your autoprovisioning file, it may force a firmware update even if the firmware version has not changed.

The <FirmwareFile> name can contain path elements (i.e. /path/to/firmware/10.3.0-ulmage-[device_file_name]).

The device also supports product strings for downloading firmware. If the <FirmwareFile> option is not set, the device will look for its particular product string for a firmware filename. In this way, a generic autoprovisioning file can specify unique firmware for a range of products.

The list of valid product strings:

```

<ProductString>CallButton31</ProductString>
<ProductString>EmergencyIntercom31</ProductString>
<ProductString>EmergencyIntercom31SW</ProductString>
<ProductString>IndoorIntercom31</ProductString>
<ProductString>IndoorIntercom31SW</ProductString>
<ProductString>IndoorKeypad31</ProductString>
<ProductString>IndoorKeypad31SW</ProductString>
<ProductString>OfficeRinger31</ProductString>
<ProductString>OfficeRinger31SW</ProductString>
<ProductString>OutdoorIntercom31</ProductString>
<ProductString>OutdoorIntercom31SW</ProductString>
<ProductString>OutdoorKeypad31</ProductString>
<ProductString>OutdoorKeypad31SW</ProductString>
<ProductString>Strobe31</ProductString>
<ProductString>Strobe31SW</ProductString>

```

Autoprovisioning
Example 1

Here's a simple example using four autoprovisioning files to configure two devices:

We boot up two devices with mac addresses **00:20:f7:02:00:01** and **00:20:f7:02:00:02** (Device1 and Device2).

The devices are set to use DHCP and that server provides an autoprovisioning server address with option 43. The address is "https://autoprovtest.server.net." The files on this server are as follows:

000000cd.xml

```
<MiscSettings>
<DeviceName>CyberData Autoprovisioned</DeviceName>
<AutoprovFile>sip_common.xml</AutoprovFile>
<AutoprovFile>sip_[macaddress].xml</AutoprovFile>
</MiscSettings>
```

sip_common.xml

```
<SIPSettings>
<SIPServer>10.0.0.253</SIPServer>
<RemoteSIPPort>5060</RemoteSIPPort>
</SIPSettings>
```

sip_0020f7020001.xml

```
<SIPSettings>
<SIPUserID>198</SIPUserID>
<SIPAuthPassword>ext198</SIPAuthPassword>
<DialoutExtension0>204</DialoutExtension0>
</SIPSettings>
```

sip_0020f7020002.xml

```
<SIPSettings>
<SIPUserID>500</SIPUserID>
<SIPAuthPassword>ext500</SIPAuthPassword>
<DialoutExtension0>555</DialoutExtension0>
</SIPSettings>
```

On boot, Device1 tries to fetch the file **0020f7023614.xml** from "https://autoprovtest.server.net". This file is not available, so device1 then tries to fetch the file **000000cd.xml**. This file exists, and Device1 parses the three elements.

1. Device1 changes its device name to **CyberData Autoprovisioned**.
2. Device1 finds an AutoprovFile element containing the filename **sip_common.xml**. The device downloads **sip_common.xml** from "https://autoprovtest.server.net," and imports this configuration, setting the sip server to **10.0.0.253** and the remote port to **5060.3**.
3. Device1 finds another AutoprovFile element containing the filename **sip_[macaddress].xml**. The device replaces the **[macaddress]** with its own mac address value creating **sip_0020f7020001.xml**, downloads this file from "https://autoprovtest.server.net," and imports this configuration. This sets the user ID to **198**, the password to **ext198**, and the dialout extension to **204**. Device1 is now finished with autoprovisioning.

Device2 goes through the same steps by setting its device name to **CyberData Autoprovisioned**, its SIP server to **10.0.0.253**, and its port to **5060**. When Device2 “sees” **sip_[macaddress].xml**, Device2 replaces it with its own mac address and downloads **sip_0020f7020002.xml** from “https://autoprovtest.server.net.” Device2 sets the SIP User ID to **500**, the password to **ext500**, and the dialout extension to **555**.

Autoprovisioning Example 2

Here is another example of setting up your autoprovisioning files:

We boot up two devices with mac addresses **00:20:f7:02:00:01** and **00:20:f7:02:00:02** (Device1 and Device2) and boot them on a network with a DHCP server configured with an autoprovisioning server at **10.0.1.3** on option **150**. Our TFTP server has three files:

0020f7020001.xml

```
<MiscSettings>
<AutoprovFile>common_settings.xml</AutoprovFile>
</MiscSettings>
<SIPSettings>
<SIPUserID>198</SIPUserID>
<SIPAuthPassword>ext198</SIPAuthPassword>
<DialoutExtension0>204</DialoutExtension0>
</SIPSettings>
```

0020f7020002.xml

```
<MiscSettings>
<AutoprovFile>common_settings.xml</AutoprovFile>
</MiscSettings>
<SIPSettings>
<SIPUserID>500</SIPUserID>
<SIPAuthPassword>ext500</SIPAuthPassword>
<DialoutExtension0>555</DialoutExtension0>
</SIPSettings>
```

common_settings.xml

```
<MiscSettings>
<DeviceName>CyberData Autoprovisioned</DeviceName>
</MiscSettings>
<SIPSettings> <SIPServer>10.0.0.253</SIPServer>
<RemoteSIPPort>5060</RemoteSIPPort>
</SIPSettings>
```

1. On boot, Device1 downloads **0020f7020001.xml** from **10.0.1.3** and imports these values. The SIP User ID is **198**, the password is **ext198**, and the dialout extension is **204**.

2. Device1 then gets the filename **common_settings.xml** from the AutoprovFile element and downloads this file from the TFTP server at **10.0.1.3**. and imports these settings. The device name is set to **CyberData Autoprovisioned**, the SIP server is set to **10.0.0.253**, and the port is set to **5060**.

Device2 does the same except it downloads **0020f7020002.xml** on boot and imports these values instead. The Sip User ID is **500**, password is **ext500**, and dialout extension is **555**. Device2 then downloads the **common_settings.xml** file and imports those values. The device name is set to **CyberData Autoprovisioned**, the SIP server is set to **10.0.0.253**, and the port is set to **5060**.

XML Files

XML files can contain <AutoprovFile> elements. If multiple DHCP options are specified, the device will try to download auto provisioning files from each in turn. The device will only look for <AutoprovFile> elements in the first file downloaded from each server. You can specify up to 20 <AutoprovFile> elements in the first auto provisioning file.

There are numerous ways to change an element of the **configuration(xml)** file. Using **sip ext** as an example, the extension can be changed:

Within the device-specific xml, i.e. **[macaddress].xml**, via the AutoprovFile element:<SIPSettings>/<SIPExt>

From the device specific xml, a pointer to a sip_common file

From the device specific xml, a pointer to the device specific sip_[macaddress].xml

From the common file, a pointer to sip_common.xml

From the common file, a pointer to the device specific (sip_[macaddress].xml)

Autoprovisioned Audio Files

Audio files are stored in non-volatile memory and an auto provisioned audio file will only have to be downloaded once for each device. Loading many audio files to the device from the web page could cause it to appear unresponsive. If this happens, wait until the transfer is complete and then refresh the page.

The device uses the file name to determine when to download a new audio file. This means that if you used auto provisioning to upload a file and then changed the contents of this file at the TFTP server, the device will not recognize that the file has changed (because the file name is the same).

Since audio files are stored in non-volatile memory, if auto provisioning is disabled after they have been loaded to the board, the audio file settings will not change. You can force a change to the audio files on the board by clicking **Restore Default** on the **Audio** page or by changing the auto provisioning file with “**default**” set as the file name.

2.3.11.2 Sample dhcpd.conf

```
#
# Sample configuration file for ISC dhcpd for Debian
#

ddns-update-style none;

option domain-name "voiplab";
option domain-name-servers 10.0.0.252;
option option-150 code 150 = ip-address;
option ntp-servers north-america.pool.ntp.org;
option space VendorInfo;
option VendorInfo.text code 10 = { text };
authoritative;
log-facility local7;

subnet 10.0.0.0 netmask 255.0.0.0 {
    max-lease-time 3600;
    default-lease-time 3600;

    option routers                10.0.0.1;
    option subnet-mask            255.0.0.0;

    option domain-name            "voiplab";
    option domain-name-servers    10.0.0.252;

    option time-offset            -8;          # Pacific Standard Time

#   option www-server             99.99.99.99;      # OPTION 72

#   option tftp-server-name       "10.0.1.52";      # OPTION 66
#   option tftp-server-name       "http://test.cyberdata.net"; # OPTION 66

#   option option-150             10.0.0.252;      # OPTION 150

# These two lines are needed for option 43
#   vendor-option-space VendorInfo;                # OPTION 43
#   option VendorInfo.text "http://test.cyberdata.net"; # OPTION 43

    range 10.10.0.1 10.10.2.1; }

```

2.3.11.3 Download Template Button

The **Download Template** button allows the user to generate, download, edit, and then store an auto provisioning template on the server that serves the auto provisioning files for devices.

To generate an auto provisioning template directly from the device, complete the following steps:

1. On the **Auto provisioning** page, click on the **Download Template** button.
2. You will see a window prompting you to save a configuration file (**.xml**) to a location on your computer ([Figure 2-23](#)). The configuration file is the basis for the default configuration settings for your unit).
3. Choose a location to save the configuration file and click on **OK**. See [Figure 2-23](#).

Figure 2-23. Configuration File

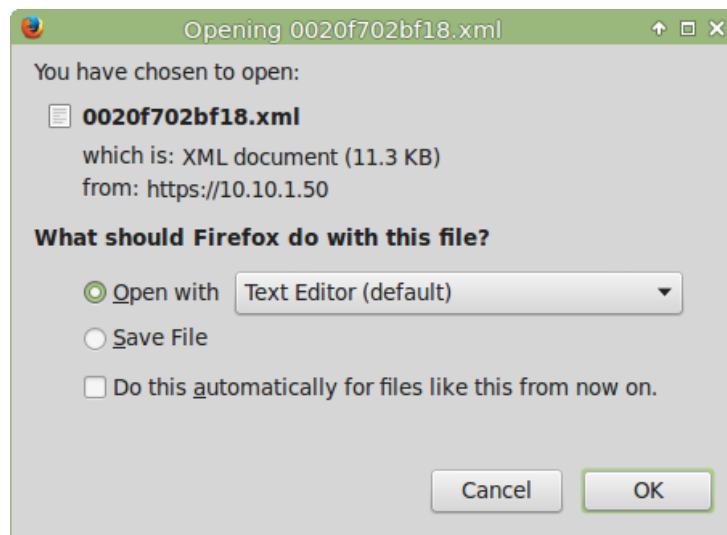

4. At this point, you can open and edit the auto provisioning template to change the configuration settings in the template for the unit.
5. You can then upload the auto provisioning file to a TFTP or HTTP server where the file can be loaded onto other devices.

2.4 Upgrade the Firmware and Reboot the Multicast Ceiling Speaker

2.4.1 Downloading the Firmware

To download the firmware to your computer:

1. Download the latest firmware file from the **Downloads** tab at the following webpage:
<http://www.cyberdata.net/products/011505/>
2. Unzip the firmware version file. This file may contain the following:
 - Firmware file
 - Release notes
3. Log in to the Multicast Ceiling Speaker home page as instructed in [Section 2.3.4, "Log in to the Configuration Home Page"](#).
4. Click on the **Firmware** menu button to open the **Firmware** page. See [Figure 2-24](#).

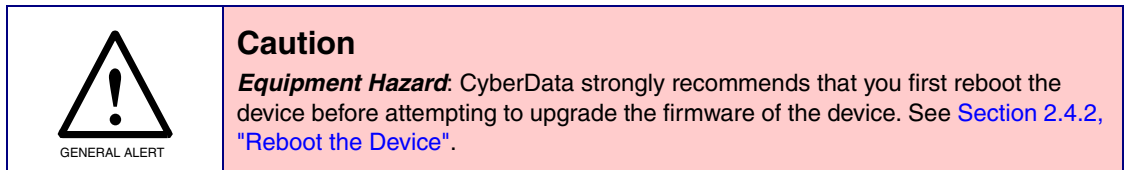
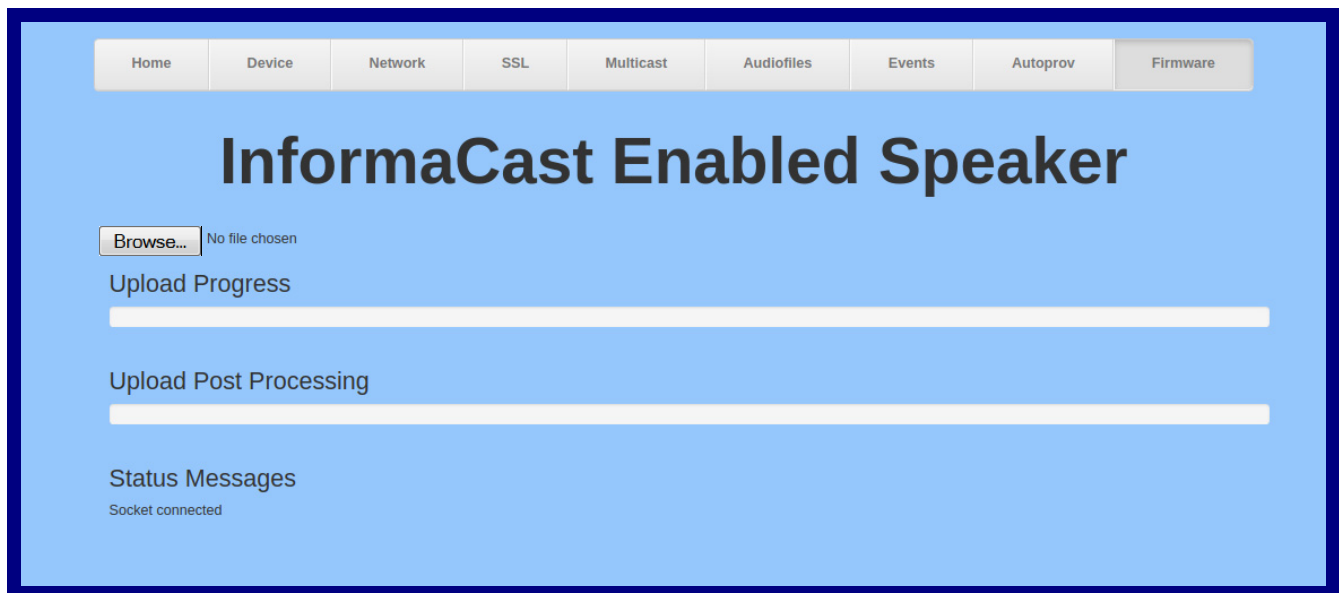

Figure 2-24. Firmware Page



5. Click on the **Browse** button, and then navigate to the location of the firmware file.

6. Select the firmware file. This reveals the **Upload** button (Figure 2-25).

Figure 2-25. Upload Button

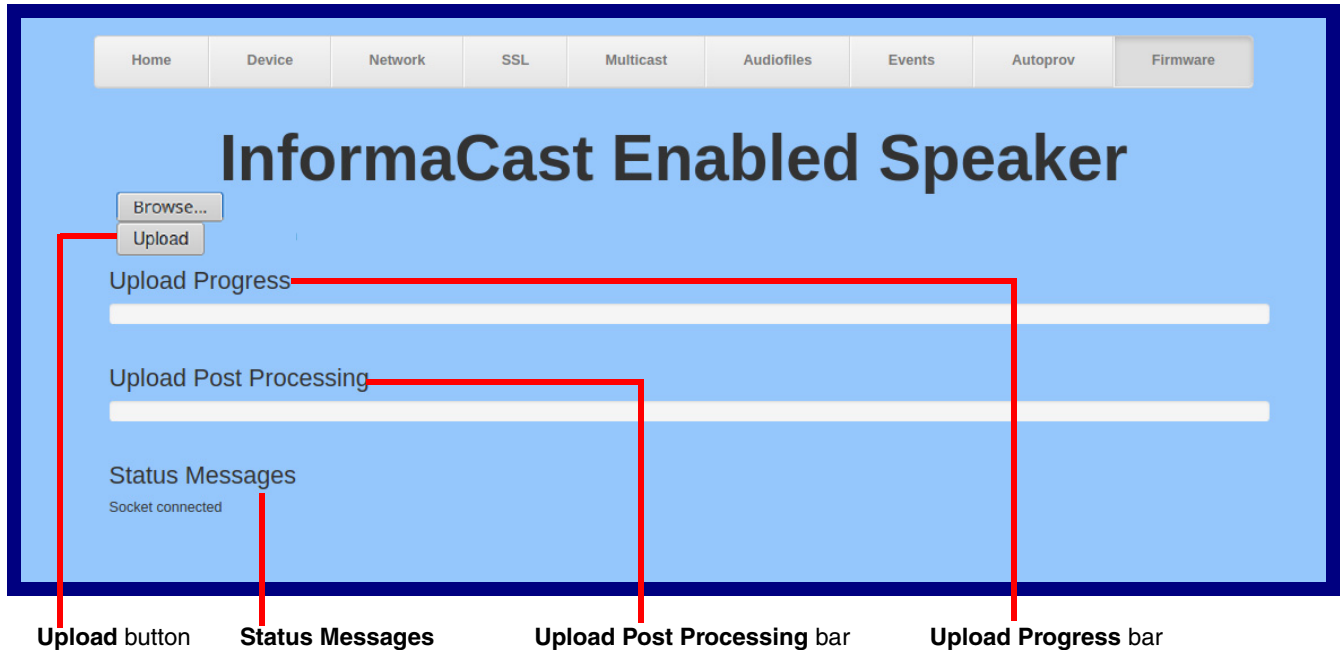



7. Click on the **Upload** button. After selecting the **Upload** button, you will see the progress of the upload in the **Upload Progress** bar.
8. When the upload is complete, you will see the words **Upload finished** under **Status Messages**.
9. At this point, you will see the progress of the upload's post processing in the **Upload Post Processing** bar.

Note Do not reboot the device before the upgrading process is complete.

10. When the process is complete, you will see the words **SWUPDATE Successful** under **Status Messages**.
11. The device will reboot automatically.
12. The **Home** page will display the version number of the firmware and indicate which boot partition is active.

Table 2-14 shows the web page items on the **Firmware** page.

Table 2-14. Firmware Page Parameters

Web Page Item	Description
	Use the Browse button to navigate to the location of the Intercom firmware file that you want to upload.
	Click on the Upload button to automatically upload the selected firmware and reboot the system. Note: This button only appears after the user has selected a firmware file.
Upload progress	Status bar indicates the progress in uploading the file.
Upload Post Processing	Status bar indicates the progress of the software installation.
Status Messages	Messages relevant to the firmware update process appear here.

2.4.2 Reboot the Device

To reboot a Multicast Ceiling Speaker, log in to the web page as instructed in [Section 2.3.4, "Log in to the Configuration Home Page"](#).

1. Click on the **Reboot** button on the **Home** page ([Figure 2-26](#)). A normal restart will occur.

Figure 2-26. Home Page

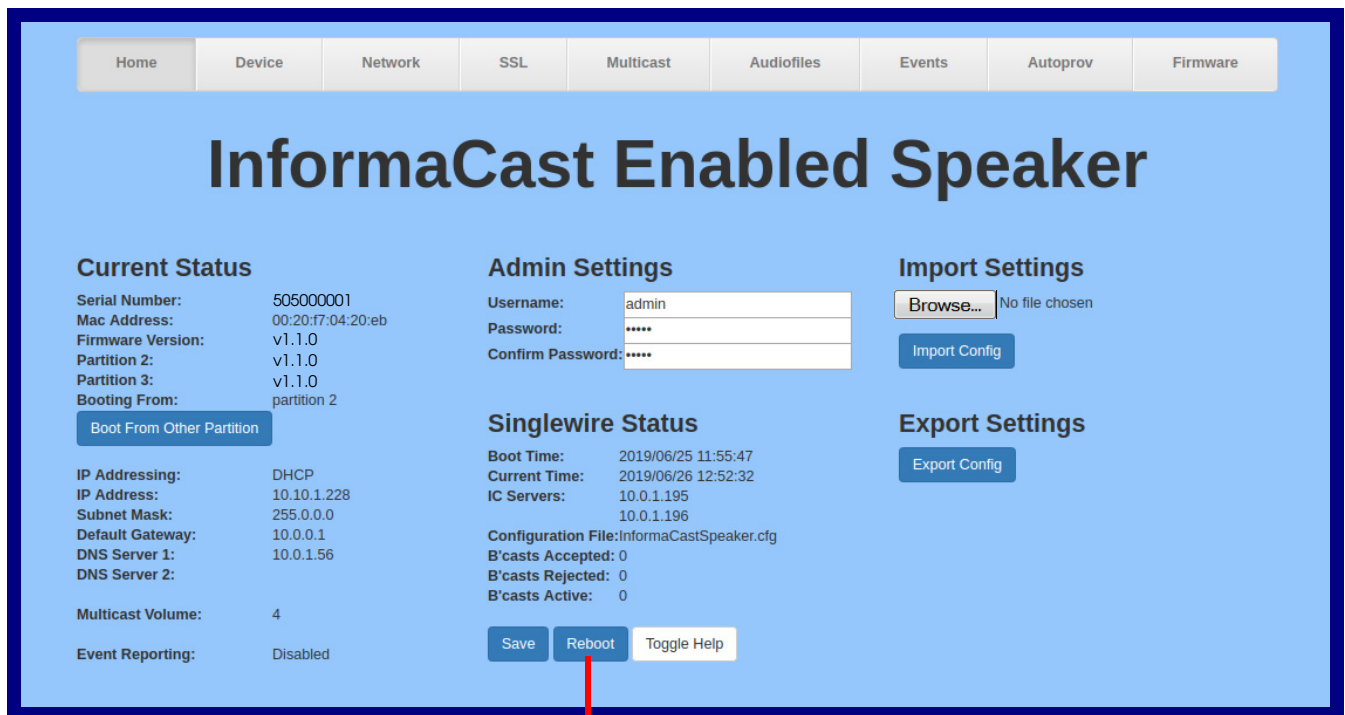

Reboot

2.5 Command Interface

Some functions on the device can be activated using simple POST commands to the web interface. The examples in [Table 2-15](#) use the free unix utility, **wget**, but any program that can send http POST commands to the device should work.

2.5.1 Command Interface Post Commands

Note These commands require an authenticated session (a valid username and password to work).

Table 2-15. Command Interface Post Commands

Device Action	HTTP Post Command ^a
Reboot	wget --user admin --password admin --auth-no-challenge --quiet -O /dev/null --no-check-certificate "https://10.10.1.154/command" --post-data "request=reboot"
Test Audio	wget --user admin --password admin --auth-no-challenge --quiet -O /dev/null --no-check-certificate "https://10.10.1.154/command" --post-data "request=test_audio"
Speak IP Address	wget --user admin --password admin --auth-no-challenge --quiet -O /dev/null --no-check-certificate "https://10.10.1.154/command" --post-data "request=speak_ip_address"
Play the "0" audio file	wget --user admin --password admin --auth-no-challenge --no-check-certificate "https://10.10.1.138/audiofiles/" --quiet -O /dev/null --post-data "0=Play"
Play the "1" audio file	wget --user admin --password admin --auth-no-challenge --no-check-certificate "https://10.10.1.138/audiofiles/" --quiet -O /dev/null --post-data "1=Play"
Play the "2" audio file	wget --user admin --password admin --auth-no-challenge --no-check-certificate "https://10.10.1.138/audiofiles/" --quiet -O /dev/null --post-data "2=Play"
Play the "3" audio file	wget --user admin --password admin --auth-no-challenge --no-check-certificate "https://10.10.1.138/audiofiles/" --quiet -O /dev/null --post-data "3=Play"
Play the "4" audio file	wget --user admin --password admin --auth-no-challenge --no-check-certificate "https://10.10.1.138/audiofiles/" --quiet -O /dev/null --post-data "4=Play"
Play the "5" audio file	wget --user admin --password admin --auth-no-challenge --no-check-certificate "https://10.10.1.138/audiofiles/" --quiet -O /dev/null --post-data "5=Play"
Play the "6" audio file	wget --user admin --password admin --auth-no-challenge --no-check-certificate "https://10.10.1.138/audiofiles/" --quiet -O /dev/null --post-data "6=Play"
Play the "7" audio file	wget --user admin --password admin --auth-no-challenge --no-check-certificate "https://10.10.1.138/audiofiles/" --quiet -O /dev/null --post-data "7=Play"

Table 2-15. Command Interface Post Commands (continued)

Device Action	HTTP Post Command^a
Play the "8" audio file	wget --user admin --password admin --auth-no-challenge --no-check-certificate "https://10.10.1.138/audiofiles/" --quiet -O /dev/null --post-data "8=Play"
Play the "9" audio file	wget --user admin --password admin --auth-no-challenge --no-check-certificate "https://10.10.1.138/audiofiles/" --quiet -O /dev/null --post-data "9=Play"
Play the "Dot" audio file	wget --user admin --password admin --auth-no-challenge --no-check-certificate "https://10.10.1.138/audiofiles/" --quiet -O /dev/null --post-data "d=Play"
Play the Audio Test	wget --user admin --password admin --auth-no-challenge --no-check-certificate "https://10.10.1.138/audiofiles/" --quiet -O /dev/null --post-data "audiotest=Play"
Play the "Page Tone" audio file	wget --user admin --password admin --auth-no-challenge --no-check-certificate "https://10.10.1.138/audiofiles/" --quiet -O /dev/null --post-data "pagetone=Play"
Play the "Your IP Address Is" audio file	wget --user admin --password admin --auth-no-challenge --no-check-certificate "https://10.10.1.138/audiofiles/" --quiet -O /dev/null --post-data "youripaddressis=Play"
Play the "Rebooting" audio file	wget --user admin --password admin --auth-no-challenge --no-check-certificate "https://10.10.1.138/audiofiles/" --quiet -O /dev/null --post-data "rebooting=Play"
Play the "Restoring Default" audio file	wget --user admin --password admin --auth-no-challenge --no-check-certificate "https://10.10.1.138/audiofiles/" --quiet -O /dev/null --post-data "restoringdefault=Play"
Swap boot partitions	wget --user admin --password admin --auth-no-challenge --quiet -O /dev/null --no-check-certificate "https://10.10.1.154/command" --post-data "request=swap_boot_partition"

a. Type and enter all of each http POST command on one line.

A.1 Mounting

See [Figure A-1](#) for instructions on how to mount the speaker.

Figure A-1. Mounting the Speaker

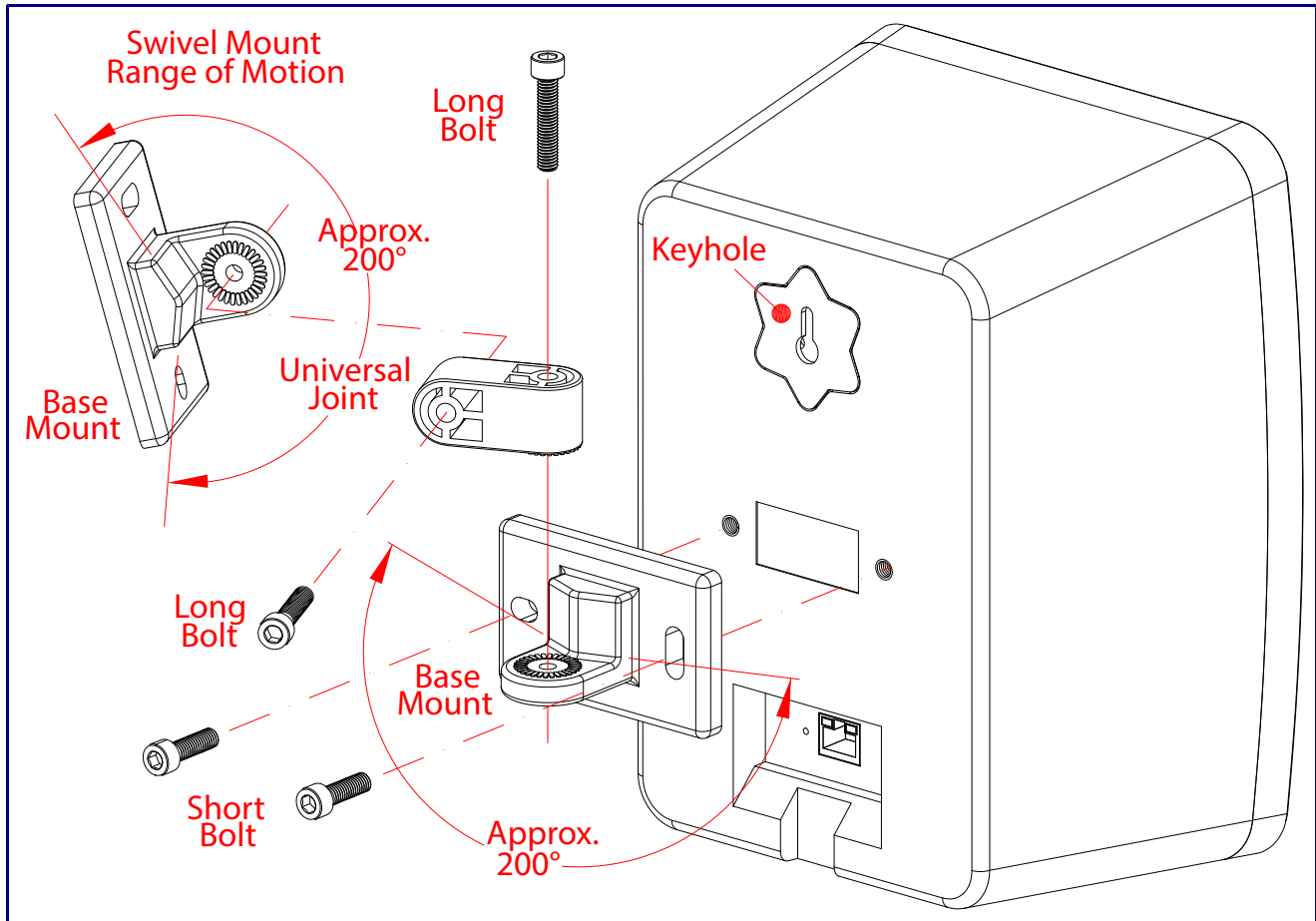

A.2 Dimensions

Figure A-2 shows the dimensions for the InformaCast Enabled Ceiling Speaker.

Figure A-2. Dimensions

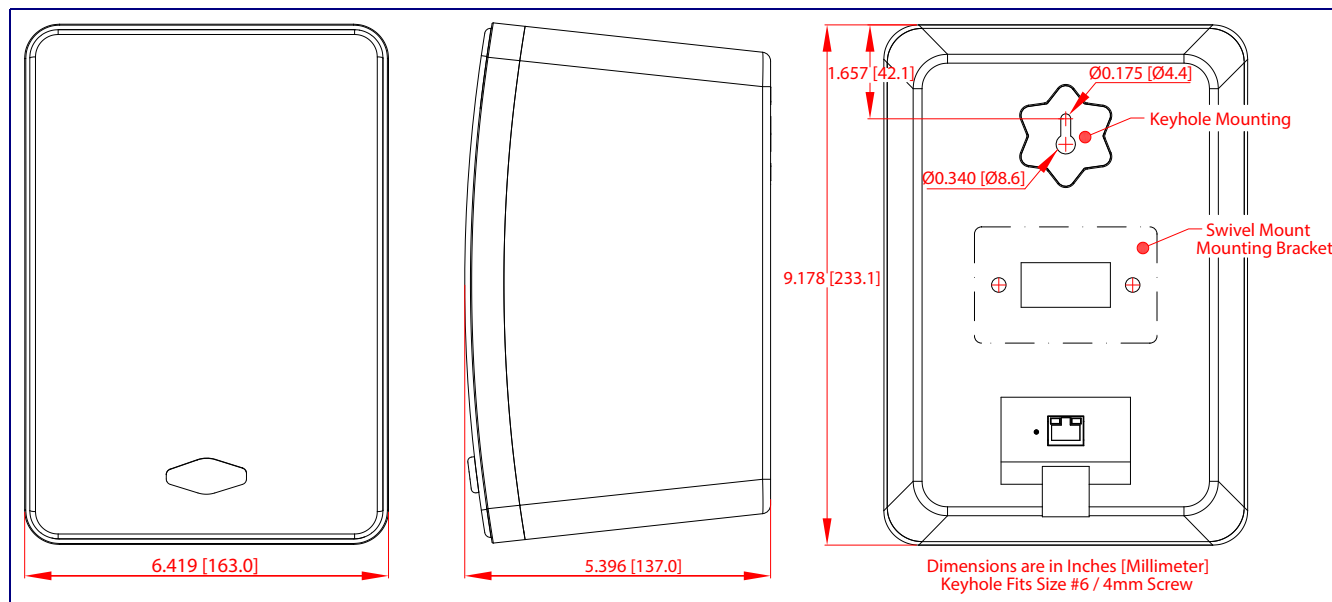

Appendix C: Setting up a TFTP Server

C.1 Set up a TFTP Server

C.1.1 Autoprovisioning requires a TFTP server for hosting the configuration file.

C.1.2 In a LINUX Environment

To set up a TFTP server on LINUX:

1. Create a directory dedicated to the TFTP server, and move the files to be uploaded to that directory.
2. Run the following command where `/tftpboot/` is the path to the directory you created in [Step 1](#): the directory that contains the files to be uploaded. For example:

```
in.tftpd -l -s /tftpboot/your_directory_name
```

C.1.3 In a Windows Environment

You can find several options online for setting up a Windows TFTP server. This example explains how to use the Solarwinds freeware TFTP server, which you can download at:

<https://www.cyberdata.net/pages/solarwinds>

To set up a TFTP server on Windows:

1. Install and start the software.
2. Select **File/Configure/Security** tab/**Transmit Only**.
3. Make a note of the default directory name, and then move the firmware files to be uploaded to that directory.

Appendix C: Troubleshooting/Technical Support

C.1 Frequently Asked Questions (FAQ)

To see a list of frequently asked questions for your product, click on the **FAQs** tab at the following webpage:

<http://www.cyberdata.net/products/011505/>

C.2 Documentation

The documentation for this product is released in an English language version only.

To download PDF copies of CyberData product documentation, click on the **Downloads** tab at the following webpage:

<http://www.cyberdata.net/products/011505/>

C.3 Contact Information

Contact CyberData Corporation
 3 Justin Court
 Monterey, CA 93940 USA
 www.CyberData.net
 Phone: 800-CYBERDATA (800-292-3732)
 Fax: 831-373-4193

Sales Sales 831-373-2601, Extension 334

Technical The fastest way to get technical support for your VoIP product is to submit a VoIP Technical
Support Support form at the following website:

<http://support.cyberdata.net/>

The Support Form initiates a ticket which CyberData uses for tracking customer requests. Most importantly, the Support Form tells us which PBX system and software version that you are using, the make and model of the switch, and other important information. This information is essential for troubleshooting. Please also include as much detail as possible in the **Comments** section of the Support Form.

Phone: (831) 373-2601, Extension 333

C.4 Warranty and RMA Information

The most recent warranty and RMA information is available at the following website address:

<http://support.cyberdata.net/>

Index

A

address, configuration login 18
 adjusting volume 13
 announcing a speaker's IP address 12, 13
 audio configuration 35
 audio configuration page 35
 audio files, user-created 37
 audio output 5
 audio test 12, 13
 autoprovision at time (HHMMSS) 45
 autoprovision when idle (in minutes > 10) 45
 autoprovisioning 45, 46
 download template button 45
 autoprovisioning autoupdate (in minutes) 45
 autoprovisioning configuration 44, 45
 autoprovisioning filename 45
 autoprovisioning server (IP Address) 45

C

changing
 the web access password 22
 command interface 59
 commands 59
 configurable parameters 23, 26
 configuration
 audio 35
 default IP settings 14
 device 8
 door sensor 28
 intrusion sensor 28
 network 25
 configuration home page 18
 configuration page
 configurable parameters 23, 26
 confirming IP address 12, 13
 contact information 65
 contact information for CyberData 65
 current network settings 26
 CyberData contact information 65

D

default
 gateway 8, 14
 IP address 8, 14
 subnet mask 8, 14

 username and password 8, 14
 web login username and password 18
 default gateway 8, 14, 26
 default IP settings 14
 default login address 18
 device configuration 8, 22
 device configuration parameters 45
 the device configuration page 44
 device configuration page 22
 device configuration parameters 23
 device configuration password
 changing for web configuration access 22
 dimensions 5
 discovery utility program 18
 DNS server 26
 download autoprovisioning template button 45

E

export settings 20, 21

F

factory default settings
 how to set 13
 features 3
 firmware
 where to get the latest firmware 55

G

get autoprovisioning template 45

H

home page 18
 http POST command 59

I

identifying your product 1
 import settings 20, 21
 import/export settings 20, 21

- IP address 8, 14, 26
- IP addressing
 - default
 - IP addressing setting 8, 14

L

- Linux, setting up a TFTP server on 63
- log in address 18

M

- MGROUP
 - MGROUP Name 34
- multicast configuration 33, 35
- Multicast IP Address 34

N

- navigation (web page) 15
- navigation table 15
- network configuration 25
- network link activity, verifying 11
- Nightringer 54
- NTP server 23

O

- overview 1

P

- password
 - login 18
 - restoring the default 8, 14
- polycom default channel 34
- polycom emergency channel 34
- polycom priority channel 34
- POST command 59
- power, connecting to speaker 9
- product
 - parts list 7
- product features 3
- product overview 1
 - product features 3
 - product specifications 5
- product specifications 5

R

- reboot 57, 58
- Reset Test Function Management (RTFM) button 12, 13
- restoring the factory default settings 13
- RTFM button 12, 13

S

- sales 65
- sensor setup page 28
- sensor setup parameters 28
- service 65
- subnet mask 8, 14, 26

T

- tech support 65
- technical support, contact information 65
- testing audio 12, 13
- TFTP server 63

U

- username
 - changing for web configuration access 22
 - default for web configuration access 18
 - restoring the default 8, 14

V

- verifying
 - network link and activity 11
 - power on to speaker 11
- VLAN ID 26
- VLAN Priority 26
- VLAN tagging support 26
- VLAN tags 26
- volume
 - multicast volume 23
- volume, adjusting 13

W

- warranty policy at CyberData 65
- web access password 8, 14
- web access username 8, 14

web configuration log in address 18
web page
 navigation 15
web page navigation 15
wget, free unix utility 59
Windows, setting up a TFTP server on 63