

1.0 Out-of-Box and Prior to Final Installation

- 1.1. Verify that you have received all of the parts listed on the *Installation Quick Reference* placemat.
- 1.2. Download the current manual, otherwise known as an *Operations Guide*, which is available in the **Downloads** tab at the following webpage:
<https://www.cyberdata.net/products/011404/>

Note You can also navigate to the **Downloads** tab by going to www.CyberData.net and following the steps that are indicated by the following figures:

1

A OUR PRODUCTS



B VOIP PRODUCTS



011404 SIP LOUDSPEAKER AMPLIFIER-AC-POWERED



2



SIP



Downloads



2.0 Select Power Source

IEEE 802.3af or 802.3at PoE Switch	IEEE 802.3af or 802.3at PoE Injector
Set PoE power type to Class 0 = 15.4W OR for high power PoE+ set Class 4 = 30W	CAT6 cable recommended— for longer distances
Be sure you are using a non-PoE switch or port	
Make sure port is not in trunk mode	
Set port to full duplex/ 100mbps	
Spanning Tree Protocol (STP) must be disabled or Portfast enabled	

3.0 Power Test

- 3.1. Plug in the CyberData device and monitor the LED activity on the front of the device during the initialization process. See the following figure:

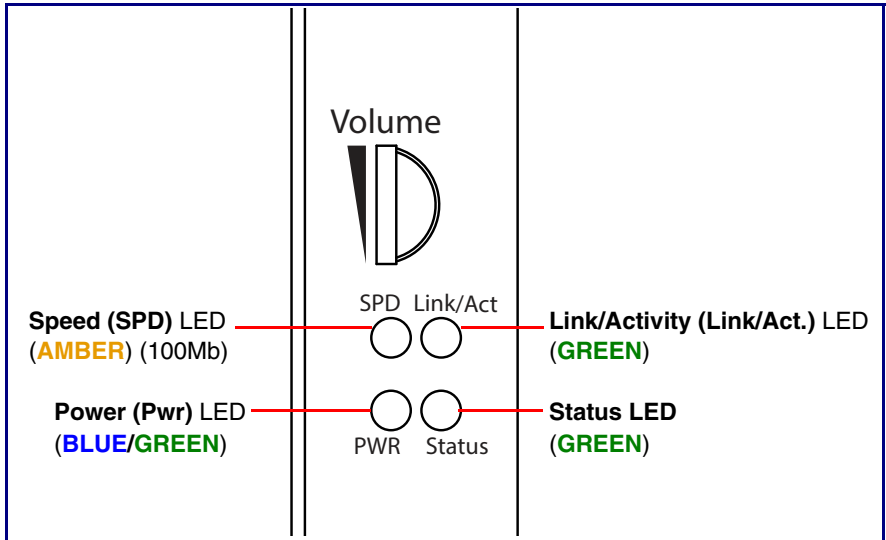

- 3.2. The **Power (Pwr)** LED is **GREEN** for 802.3af and is **BLUE** for 802.3at. The **GREEN Status** LED and the **GREEN Power (Pwr)** LED come on immediately. The **Speed (SPD)** LED illuminates **AMBER** for a 100Mb link or is off for 10MB when the network link to the device is established. The **Link/Activity** LED blinks to indicate network traffic.

After about 20 seconds, the **GREEN Status** LED will blink fast to indicate that the device is acquiring an IP address and attempting to autoprovision. It will turn off thereafter until the device has finished booting. When the device has fully booted, the **GREEN Status** LED will turn on solid.

If there is no DHCP server available on the network, it will try 12 times for 60 seconds and eventually fall back to the programmed static IP address (by default 10.10.10.10) or the previously used DHCP address if a prior lease was established. This process will take approximately 80 seconds.

- 3.3. When the device has completed the initialization process, press and hold the RTFM switch for 3 seconds to announce the IP address.

This concludes the power test. Go to [Section 4.0, "Connecting to a Network in a Test Environment"](#).

4.0 Connecting to a Network in a Test Environment

Note The following connections are usually needed for this procedure:

- Computer
- PoE switch or injector
- CyberData device

4.1. In a test environment, use a computer that is connected to the same switch as a single CyberData device. Note the subnet of the test computer.

4.2. Use the CyberData Discovery Utility program to locate the device on the network. You can download the Discovery Utility program from the following link:

<https://www.cyberdata.net/pages/discovery>

4.3. Wait for initialization to complete before using the Discovery Utility program to scan for a device. The device will show the current IP address, MAC address, and serial number.

4.4. Select the device.

4.5. Click **Launch Browser**. If the IP address is in a reachable subnet from the computer that you are using to access the device, the Discovery Utility program should be able to launch a browser window pointing to the device's IP address.

4.6. Log on to the web interface by using the default username (**admin**) and password (**admin**) to configure the device.

4.7. Perform an audio test by pressing the **Test Audio** button that is located at the bottom of the **Device Configuration** page. If the audio test message is clearly audible, then your CyberData device is functioning properly.

4.8. The device is now ready to be set for your desired network configuration. You may search the **Compatible IP-PBX Servers** index for available sample VoIP phone system configurations and set up guides at the following website address:

<https://www.cyberdata.net/pages/connecting-to-ip-pbx-servers>

5.0 Contacting CyberData VoIP Technical Support

You are welcome to call CyberData VoIP Technical Support at 831-373-2601 x333. Business hours are 7:00 AM - 5:00 PM Pacific Time, Monday through Friday.

We encourage you to access our Technical Support help desk at the following address:

<http://support.cyberdata.net/>

Note You can also access the Technical Support help desk by going to www.CyberData.net and clicking on the **SUPPORT** menu.

The Technical Support help desk provides the options of accessing documentation for your CyberData product, browsing the knowledge base, and submitting a troubleshooting ticket.

Please be advised requests for Returned Materials Authorization (RMA) numbers require an active VoIP Technical Support ticket number. A product will not be accepted for return without an approved RMA number.