

Mounting

The SIP Paging 25V/70V Amplifier has several mounting options:

1. Wall Mount - Included with each unit are mounting ears which can be attached to the SIP Paging 25V/70V Amplifier unit to mount it to a wall. Please note the hardware to mount the unit to the wall is not included.
2. Rackmount - Included with each unit are mounting ears to mount the SIP Paging 25V/70V Amplifier unit. The mounting hardware should be compatible with most standard rackmount systems. Please note the hardware to mount to the rackmount system is unique to the rackmount enclosure and this hardware is not included. Each of the units also has multiple mounting holes on the side to mount standard rail systems. For more details please visit our website or review the Operations Guide.
3. Desktop - Mounting illustrations can be found on the Installations tab or in the Operations Guide on the Downloads tab at: <https://www.cyberdata.net/pages/011579/>

Wall Mounting Utilizing Mounting Ears

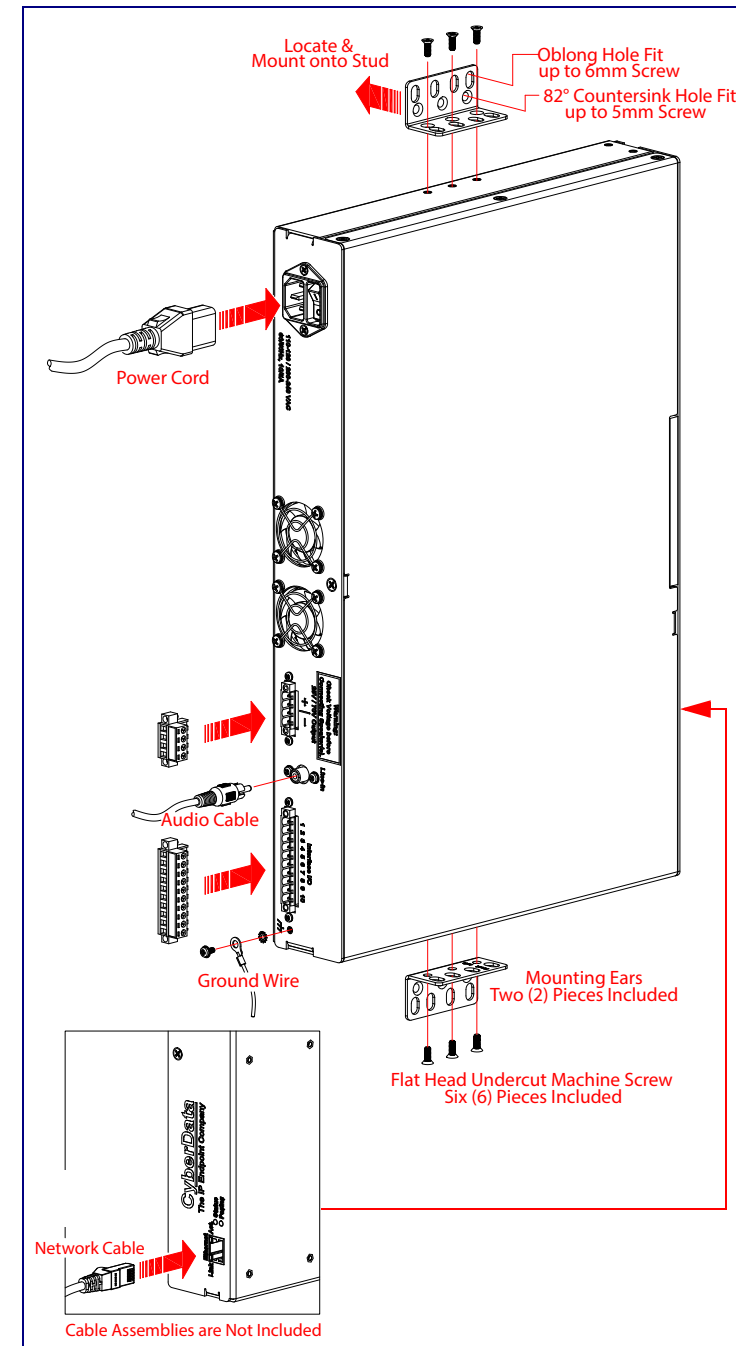

Rack Tower Installation

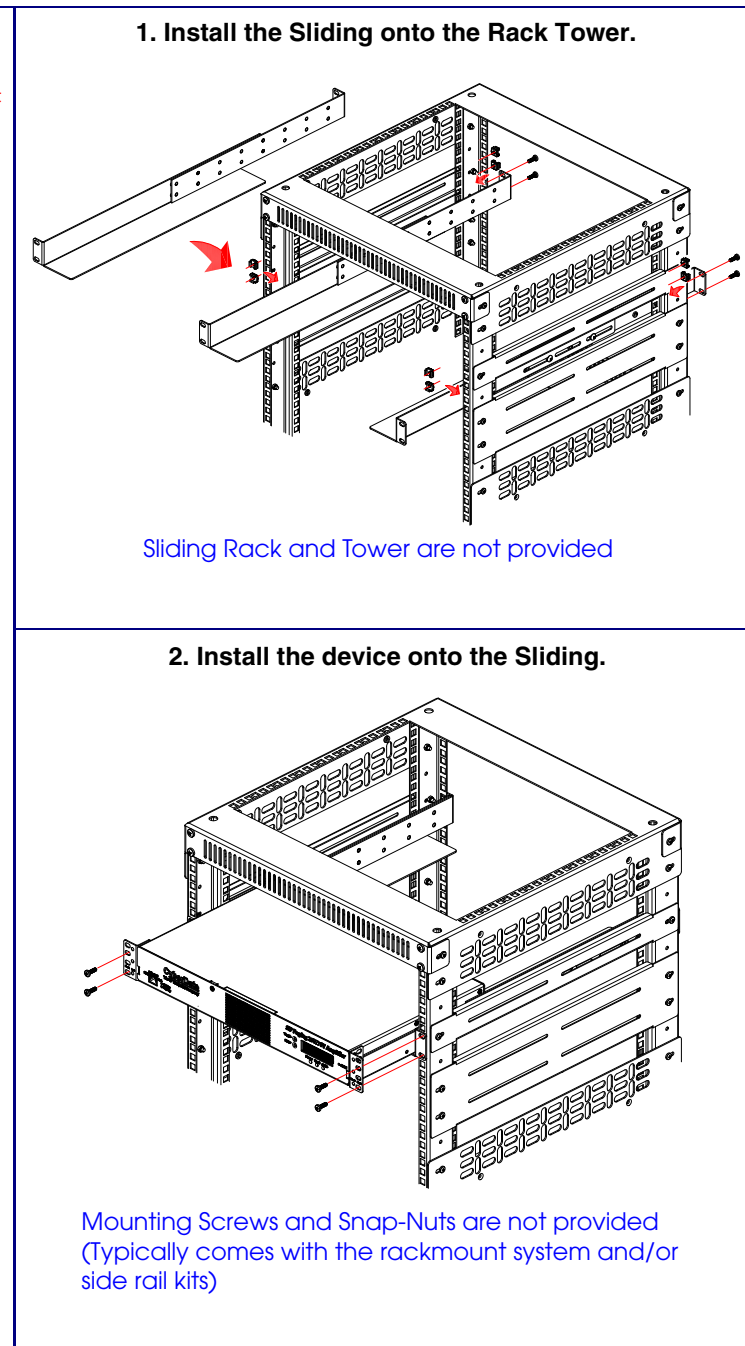

SIP Paging 25V/70V Amplifier 011579



Parameter	Factory Default Setting
IP Addressing	DHCP
IP Address ^a	192.168.1.23
Web Access Username	admin
Web Access Password	admin
Subnet Mask ^a	255.255.255.0
Default Gateway ^a	192.168.1.1

a. Default if there is not a DHCP server present.

Getting Started

- Be sure that you have received all the parts described in the [Parts List](#) section.
- Download the **Operations Guide** for the SIP Paging 25V/70V Amplifier at the following website: <https://www.cyberdata.net/pages/011579/>
- For most installations we recommend the following:
16/2 Stranded In-Wall CL3R Speaker Wire with an Insulated Jacket.
See the **Wire Recommendation** section of the Operations Guide for more details.
- **WARNING:** This product should be installed by a licensed electrician according to all local electrical and building codes.
- **WARNING:** To prevent injury, the product should be securely attached to a rackmount system, mounted flat to a wall, or placed firmly on a desk with the included rubber feet.

Parts List

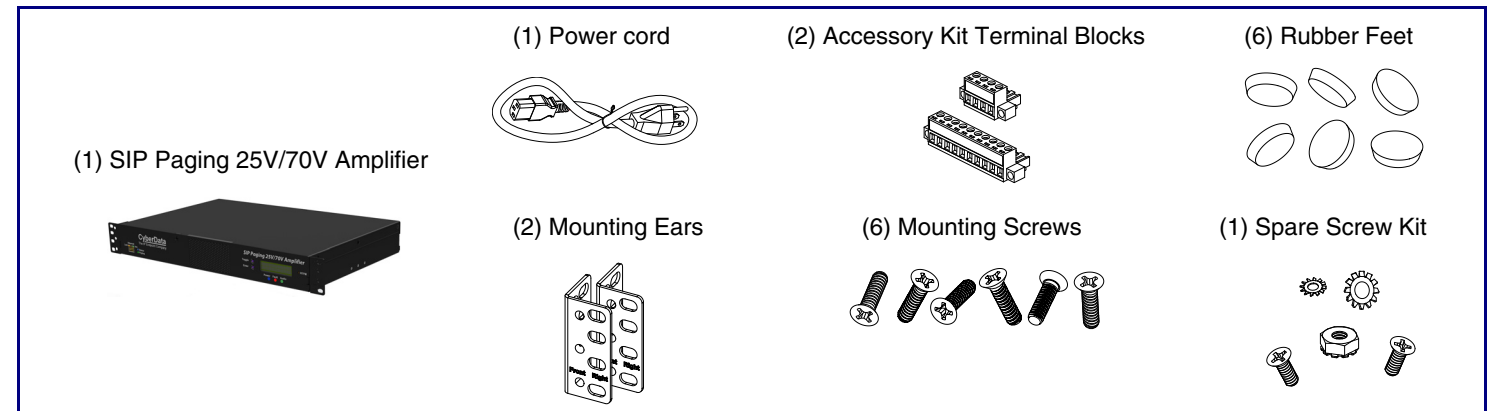

Contacting CyberData

Corporate Headquarters

CyberData Corporation
3 Justin Court
Monterey, CA 93940, USA

Phone: 831-373-2601
Fax: 831-373-4193
<https://www.cyberdata.net/>

Sales: 831-373-2601 ext. 334
Support: 831-373-2601 ext. 333
Support Website: <https://support.cyberdata.net/>
RMA Department Contact and Status: <https://support.cyberdata.net/>
Warranty Information: <https://support.cyberdata.net/>

Verifying Operations and Settings

When you apply power, turn ON the Power switch and connect the Ethernet to a live network:

- The square, **YELLOW Link** LED above the **Ethernet** port indicates that the network connection has been established at 100Mbit speed.
- The square, **GREEN Network Activity** LED above the Ethernet port will blink to indicate network activity.
- The round **GREEN/BLUE Status** LED is **BLUE**, indicating power is **ON**. Once the device is initialized, the LED will blink **GREEN** at one second intervals.
- The round **GREEN Paging** LED comes on after the device is booted and initialized. This LED blinks when a page is in progress. You can disable **Beep on Initialization** on the **Device Configuration** page.

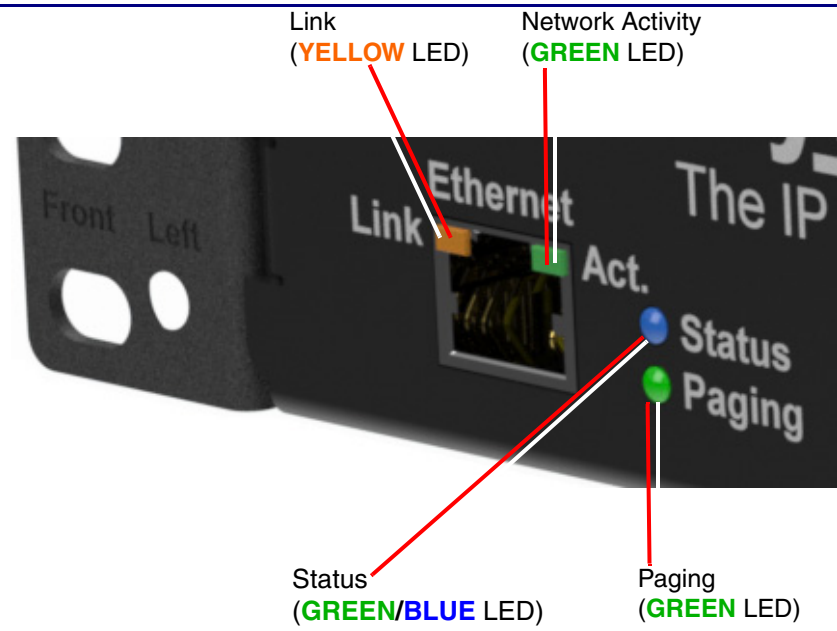

Setting Up the SIP Paging 25V/70V Amplifier



To set up the device, connect the device to your network:

Power Supply

- Connect the Amplifier to a standard 100-240VAC, 50/60Hz external power supply



Chassis Ground

- Connect the earth grounding wire to the Chassis Ground. See the figure on the left.

RTFM Switch

To restore the factory default settings:

1. Use a paper clip to press the RTFM button, bringing up the RTFM screen.
2. Use the toggle button to select **Restore Defaults**, and then **Enter** to activate.
3. Selecting **Restore Defaults** will bring up the confirmations screen, where selecting **Enter** will restore defaults.
4. If a speaker is connected, the device will announce, "restoring default configuration" and "rebooting."

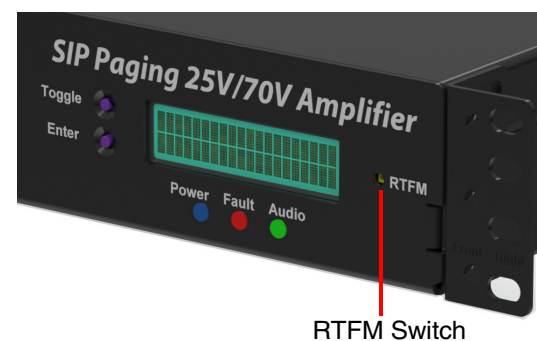

Connections

25V/70V Output

There are two connections to hook analog speakers up to the amp. The connections accept up to a 12 AWG wire.

Line in

Line level input is for background music applications. The expected input level is 2Vpp (2 volts peak to peak voltage).

Interface I/O

- | | |
|-----|-------------------------------|
| 1 | Fault Sense Input (Common) |
| 2 | Fault Sense Input (Sense) |
| 3-4 | Reserved |
| 5 | Ground Reference |
| 6 | Relay Contact - Common |
| 7 | Relay Contact - Normally Open |
| 8 | Line Level Output (+) |
| 9 | Line Level Output (-) |
| 10 | Reserved |

Warning:
Check Voltage before
Connecting Speaker(s).

25V/70V Output

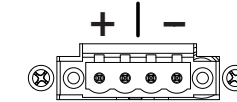

Line-in

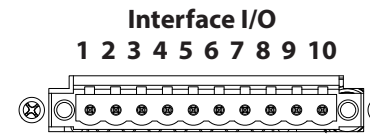

Dimensions

