

IP66 Analog Horn db Output Levels*

Power Tap Settings

Voltage	15W	10W	7W	2W
25V	117.5	117	115.2	110.4
70V	116.9	115.9	114	110.9

* dBC @ 1M and 1kHz

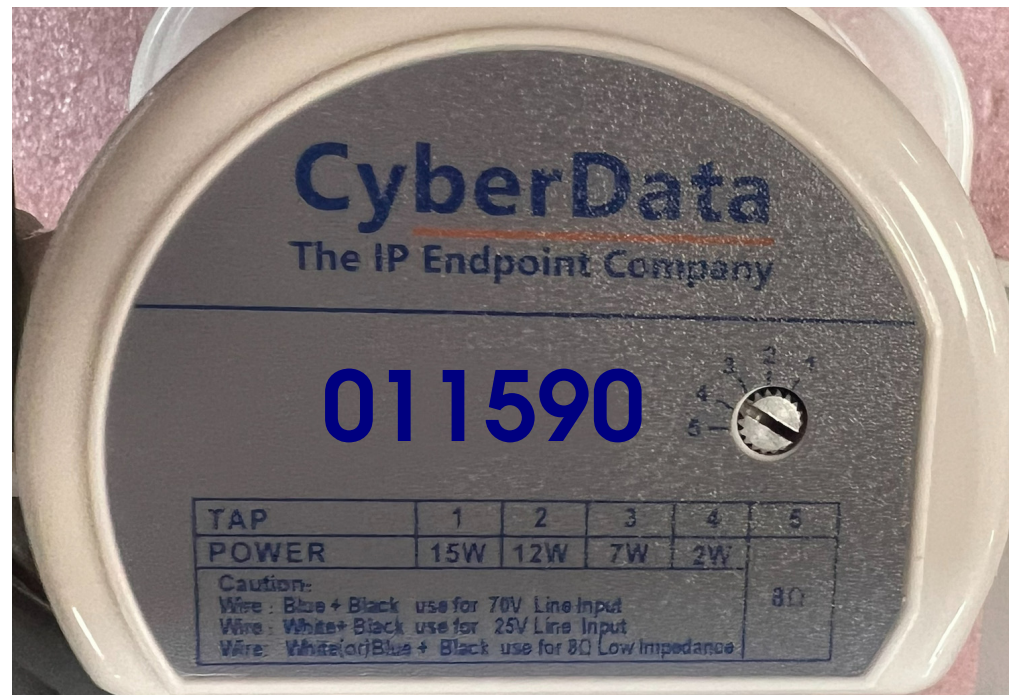

To connect constant voltage line inputs:

- Use blue and black wire for 70V.
- Use white and black wire for 25V.

To connect 8 Ohm low impedance, use white (or) blue and black wire.

Contacting CyberData

Corporate Headquarters

CyberData Corporation
 3 Justin Court
 Monterey, CA 93940, USA

Phone: 831-373-2601
 Fax: 831-373-4193

<https://www.cyberdata.net/>

Sales: 831-373-2601 ext. 334
 Support: 831-373-2601 ext. 333
 Support Website: <https://support.cyberdata.net/>
 RMA Department Contact and Status: <https://support.cyberdata.net/>
 Warranty Information: <https://support.cyberdata.net/>

CyberData
 The IP Endpoint Company

Installation Quick Reference



IP66 Analog Horn 25V/70V/8 Ohm 011590

Getting Started

- Please note that this product ships with the 2W position selected.
- **WARNING: Do not use the 8 Ohm setting in a constant voltage application.**
- **WARNING: This product must be set to the appropriate voltage depending on the settings of the amplifier. Using a speaker set to 25V in a 70V system will cause damage.**
- **WARNING: This enclosure is not rated for any AC voltages!**

Dimensions

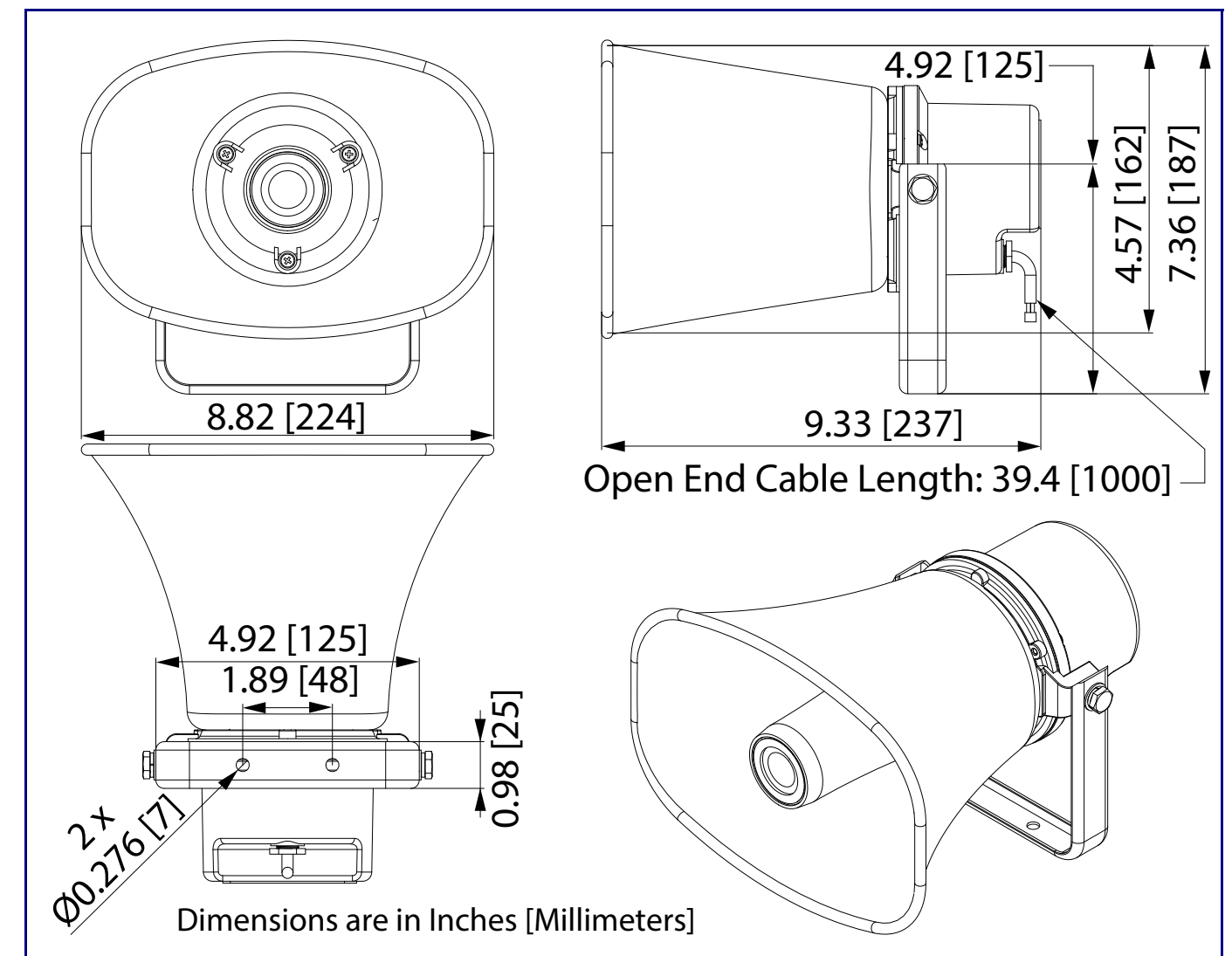

Waterproof Wire Connection

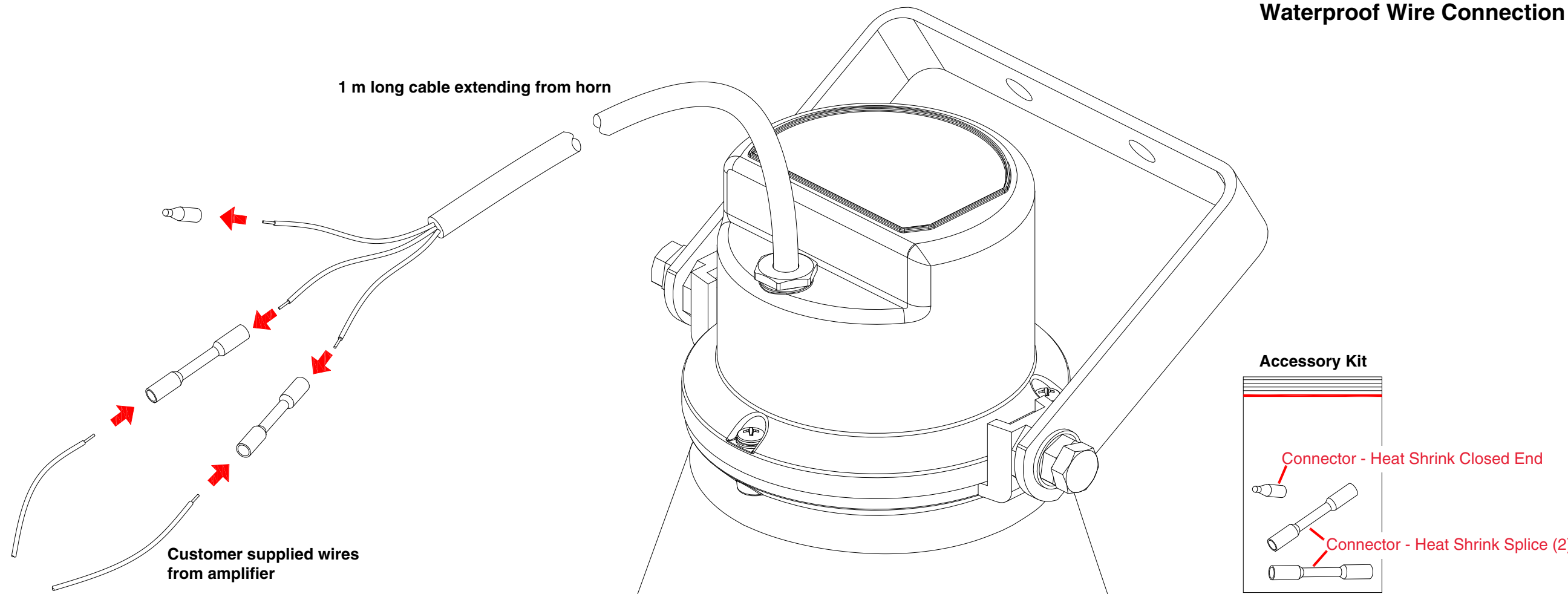

Steps for Wire Connection:

1. Confirm the connecting wire is between 16 and 22 AWG.
2. Strip the insulation to 8mm then insert into the copper barrel.
3. Crimp the insulated connector for a solid connection.
4. Heat the tubing evenly with a heat gun for about 20 seconds.
5. Terminate unused wire with supplied Heat Shrink Connector closed end. Repeat crimp and heat procedure as shown in steps 3 and 4.
6. Inspect your waterproof connection, let it cool down before use.

NOTE: check that the desired power tap settings are adjusted to the intended constant voltage level OR 8 Ohm output, depending on your amplifier.

To connect constant voltage line inputs:

- Use blue (+) and black (-) wire for 70V.
- Use white (+) and black (-) wire for 25V.

To connect 8 Ohm low impedance, use white(or)blue (+) and black (-) wire.

General Wire Recommendation for 25V or 70V Speakers

For the majority of installations we recommend the following specifications for the speaker wiring.

16/2 (16AWG/2 Conductor) Gray Stranded In-Wall CL3R Speaker Wire (see figure below)

- Use with speaker systems in an indoor audio system
- Class 3, riser rated for in-wall installation in riser and non-riser spaces
- PVC insulating jacket
- 2 fully annealed class B stranded bare copper conductors
- 16-Gauge
- UL Type CL3R
- Plenum rated

There are many brands that will work, but we have personally tested the Southwire company. The description below are the details on this wire in a 500 foot length.

P50002 SY 16/2 STR CU OAS CMP/CL3P CMP/CL3P/FPLP FT6 PLENUM SHIELDED STRANDED 185 25.07

